

viccarbe



Price List

2023 EXWORKS V03



Premio Príncipe Felipe
a la excelencia empresarial

We manufacture contemporary furniture for singular collaborative spaces

Why Viccarbe

- Our warranty period is valid for 10 years
- Average production time, 5 weeks (*25 working days*)
- Quickship program for a curated selection of products (*ready to ship in 1 week*)
- Samples and mock-ups easily provided to success with projects
- Sustainable and environmentally respectful model of management approved by ISO 9.001 and 14.001
- Quality certificates (UNE / ANSI-BIFMA)

Quality, sustainability, affordability

Our products have successfully passed strict heavy-use tests, as sign of our highest commitment to quality and user's security. Additionally, our constant search for balance has made possible the inclusion of iconic, timeless, comfortable and affordable products on the collection. The experience and know-how of the industrial network where Viccarbe is framed, has allowed us to develop an economic model based on sustainability and a careful use of resources - designing and producing furniture pieces that could last in time.

Chairs and stools	Pg. 38-187
Lounge Chairs	Pg. 188-225
Sofas	Pg. 226-311
Benches	Pg. 312-359
Tables	Pg. 360-475
Low tables	Pg. 476-499
Accessories	Pg. 500-503
Fabrics selections	Pg. 508-509



FORO TABLE

BY JOHN PAWSON
From 22.120 DKK

Pg. 364



FUNDA BOLD

BY STEFAN DIEZ
From 14.068 DKK

Pg. 190



ZOCO LOUNGE CHAIR

BY VICTOR CARRASCO
From 4.916 DKK

Pg. 188



TRIVIO TABLE

BY JASPER MORRISON
From 6.738 DKK

Pg. 360



SAVINA DOUBLE MODULE

BY VICTOR CARRASCO
From 14.280 DKK

Pg. 226

Dear customer,

Below you will find the latest additions to our collaborative furniture collection:

NEW ADDITIONS

1. **Trivio table.** Bistro style table made up of a single 80 cm table top, three solid wood legs and a connecting piece that joins all the elements with an easy assembly.
2. **Zoco lounge chair.** Zoco is a new, very comfortable lounge chair with rounded forms around which work meetings, friendly encounters and the exchange of ideas revolve and which has been designed to promote collaboration.
3. **Foro table.** Our new venture with designer John Pawson. A collection of minimalist tables meticulously crafted in oak wood, the noblest material to convey richness, warmth and depth to any environment.
4. **Funda Bold.** Suggestive and extremely comfortable. A collection of oversize seats with matching ottoman, cushions and headrests. Its large silhouette and generous proportions are created for relaxation and 'slow work' in offices, homes and in-between spaces.
5. **Double module for the Savina sofa.** The Savina family grows with the addition of the double module that corresponds to a seat and a half and allows the creation of new sofa configurations.
6. **HPL finish in Cambio table.** We extend the range of Cambio collection tabletops adding HPL with MDF.
7. **New wood stains.** Bleached oak and Walnut stained oak finishes will now be available for all woods and boards of the collection.
8. **Viccarbe Standard Fabrics.** A curated selection of fabrics available as standards, stocked in Spain, for the fastest delivery under our fast track program.



CHANGES

1. **Fire resistant upholstery.** From now on, **all of the Viccarbe upholstered products are manufactured with fire resistant fabrics.** Our technical and purchasing departments have done a huge effort to offer the best quality and safety for all the catalogue, at the same price.
2. **Updated Graded In Catalogue.** A mayor update has been done to our main catalogue, keeping up with manufacturers and customers.
2. **Burin table 90x90.** Changes its base size from Ø38 to Ø50

DISCONTINUED

- **Eli table.** Discontinued for all references.
- **Holy Day low table.** Discontinued for all references. Last order entry 18 December 2023.
- **Up In The Air low table.** Discontinued for all references. Last order entry 18 December 2023.
- **Keel shelf.** Discontinued for all references. Last order entry 18 December 2023.
- **Burin table 140x140 high 74 and 90x90 high 102.** Discontinued for all references.
- **Klip chair stacking piece.** Discontinued, the stacking system is now integrated into the chair.
- **Wenge stain finish.** Discontinued from all products in the collection.
- **Fluorescent orange metal finish.** Discontinued from all products in the collection except Trivio table, Maarten four legs base chair, swivel base and Klip four legs base chair.
- **The following fabric references are discontinued:**
Camira: ADVANTAGE, XTREME, MAIN LINE PLUS | Crevin: OPTIM, BLEND, DIVINE, TENZO, DAS | Gabriel: GO CHECK | Ecoalf: ECOALF 48.3
Kvadrat: FIELD, SAVANNA | Maharam: MESSENGER, METRIC | Rohi: SERA | Torri Lana: GUBBIO, REGGIO, RICO, SIENA, LIDO

We would like to remind you that Viccarbe does not have printed prices as we are truly committed to the fact that taking care of our environment is taking care of our future. Please do not hesitate to contact our team if you have any questions or requirements regarding our latest news.

Thank you very much,

Viccarbe

Instructions for using the pricelist

INFORMATION AVAILABLE FOR EACH PRODUCT

Each product is accompanied by a table where you will have all the necessary information when choosing the finish, the corresponding price and its associated code, to reflect it correctly in the order.

- CODE

Short sequence of letters and numbers that identifies each model of the product and that will have to be indicated in the order.

- FINISH

All the possible finish options for both lacquered and upholstered finishes, which must be chosen and indicated together with the product code.

- PUBLIC PRICE

Final price of the chosen product, associated with code and finish, which will be expressed in Euros €. In case of upholstered product, it always be fire retardant.

CODE	FINISHES	PUBLIC PRICE
Reference of each product to be indicated in the order.	It indicates for each product its possible finishes, from lacquered to upholstered. For all available finishes, see page 22.	Price of the flame retardant product, expressed in Euros €.

NAVIGATE THROUGH THE PRICE LIST



When you click on a product image in the index, the pdf will take you to the product page.





By clicking on the cover image of each product, the pdf will take you to the product's website.



SYMBOLOLOGY

 Product weight in kilograms.

 Number of boxes and volume in which the product is packed.

 Number of products contained in one box.

 Number of products that can be stacked together.



A curated selection of fabrics available as standards, stocked in Spain, for the fastest delivery under our fast track program.

SUSTAINABILITY

At Viccarbe we believe that sustainability is designing and producing furniture that will stay with us for the longest time possible. Furniture we won't want to throw out. Consequently, the concept of environmental sustainability becomes important for Viccarbe from the furniture's conception, right through its design until the end of its useful life cycle.

- We try to design products with easily interchangeable parts, making it easier to recycle the various components at the end of their life cycle.
- We take environmental impact into account when selecting raw materials. 98% of our suppliers are European, allowing us to minimise the environmental impact caused by transport. The remaining 2% come from the U.S.
- For the production of this pieces Viccarbe is using wood from certified sustainable forestry sources.
- We use powder coating on all our metallic structures.
- We offer several graded-in fabrics which are 100% made of recycled materials.
- We appropriately recycle all our waste with authorised agents.
- We carefully analyse the packaging of our product, using the quantity of cardboard, plastic or foam strictly necessary to avoid the product being damaged in any way during transport.
- For the distribution of our products we use groupage transport companies, ensuring that the trucks are full. For inter-continental transport we always go by sea. We only use aerial transport in urgent cases.

QUALITY

Viccarbe is certified by SGS in ISO 14001 and ISO 9001 as well as with the SymbolC by the Furniture Institute of Technology (AIDIMA), which guarantees that the products have been tested.



RESOURCES FOR ARCHITECTS AND DESIGNERS

We have included 2D, 3D, REVIT, and BIM files of our products at www.viccarbe.com in order to facilitate your job and be able to include them effortlessly in your design proposals. You will be able to find these documents in the "Downloads" section on our website. Here you will also find our latest catalogue and sample cards for the finishes available (woods, metals, propylene, and fabrics). As a novelty, we have incorporated individual catalogues for each product which can be found on each product webpage listing. Each brochure includes multiple product and lifestyle pictures plus every specification, certificates, and technical data you may require. You will be able to download high-quality product pictures from our gallery, facilitating the incorporation of our pieces in any design.

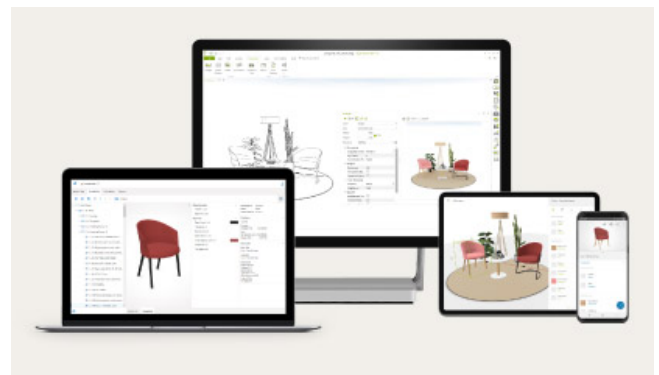

pCon

We are deeply immersed in a digitalization project and therefore we have partnered with the platform pCon and its different modules, the tool for professionals to prepare layouts and 3D projects in a quick and easy way. Our collection is available here, enabling our products to be included rapidly in your project proposals.

We have also included a new online product configurator at www.viccarbe.com/configurator, allowing to configure and visualize product compositions that match any specific project requests.

BIMobject®

Viccarbe is live on BIM Object, the global platform for the architecture and design industry where users can download technical product data such as BIM and Revit files of our furniture to configure projects and design proposals.



General sales conditions

Public pricelist valid from 1st April 2023.

To place an order implies to submit the following conditions that describe the process for proper ordering.

Price is per unit without taxes, unless any other information is stated. VICCARBE reserves the right to modify prices.

— HOW TO ORDER

All orders need to be received in written to e-mail:

export@viccarbe.com

and must contain the following information:

- A) Model name and reference
- B) Finishes
- C) Fabric reference
- D) Quantity

It is not possible to cancel or modify an order after 48 hours of the order confirmation.

It is not allowed to order spare references as frames, legs, casters...

— COMPOSITIONS

For orders that include the SAVINA, SISTEMA, SEASON SOFA or STEP sofa, it will be necessary to send a drawing of the desired composition.

— ABOUT THE FINISHES

Any model not shown in this price list is discontinued. To match the fabric or wood tonality of articles manufactured in different periods is not possible technically. The buyer accepts the tolerance when placing the order.

Viccarbe reserves the right to modify dimensions, assembling, materials or tonalities to improve the products without notice.

— CUT OUT

Viccarbe offers a series of preset positions for cut outs and power options based on the most demanded ones. If a different position were needed, please contact the sales department for assesment.

To arrange this cutting of tabletops, it is necessary to submit a drawing prepared by the Viccarbe technical department, with the signature of the customer accepting the position of the cut. No order will be put into production without signed drawings.

— VICCARBE CUSTOM

We love personal solutions, and unique design, like diversity, is part of our company ethos. Our project management team works with architects, interior designers and customers to help develop the design and create products customised to fit particular requirements for specific projects.

We are delighted to adapt our existing furniture to the needs and preferences of our customers.

Because we have total control over the production chain, we can respond to customer needs.

In the case of special orders, VICCARBE will not be liable to any customer or third party that files a claim against the customer in relation to the product included in said order, with the understanding that the characteristics of same correspond to customer requirements and have not been subjected to the usual company tests and controls.

For such purposes, "special order" shall be understood to mean those products that differ from the forms, sizes or finishes included in the VICCARBE catalogue in force at the time the order is placed.

Orders will not be processed until confirmation and acceptance are received in writing for more than 100% of the total amount in advance (this amount is only required to confirm the customer's definitive acceptance of same, and after this point no modifications will be allowed).

By accepting this quote, the customer acknowledges that it is a special order and therefore exempts VICCARBE from all liability related to same, the pieces having been manufactured at the customer's request, diverging from the forms, sizes or finishes in the VICCARBE catalogue in force at the time of the order, with the commitment to maintain VICCARBE free of liability for any claim a third party might file against VICCARBE related to same.

The delivery time will depend on the difficulty of manufacturing the piece and will be indicated in writing with the quote (minimum 10 weeks). Nonetheless, it should be noted that this timeframe will be approximate, as any complication or unforeseen circumstances encountered in the manufacturing process could delay delivery.

— PAYMENT TERMS

The first order will be paid 100% in advance with no extra discount for early payment.

For subsequent deliveries, Viccarbe will only sell on credit if such sales are covered by its insurance company; in this case, payment terms and conditions will be agreed upon individually and will never exceed 30 days.

— BANKING INFORMATION

Payments need to be settled though:

SANTANDER
SWIFT: BSCHESMMXXX
IBAN: ES56 0049 1021 1327 1032 5951

Payment must be made in full (100%), and any bank charges incurred must be paid by the buyer.

If payment is not made according to the agreed terms, a 2% monthly interest charge will be made. In the event of non-payment, the buyer will be responsible for all debt-collection costs, including legal costs and attorneys' fees as a result of legal action taken to recover the payment.

The company reserves the right to suspend deliveries in any case in which the buyer fails, even partially, to fulfill its commercial or payment obligations.

Viccarbe will remain the owner of the goods in question until the price has been paid in full (100%). The customer will be liable for costs related to repossession of the goods, regardless of their location.

If a replacement part is needed, payment will be made according to the standard payment method, with spare parts invoiced subsequently and individually; however, the total payment of the order can never be linked to partial claims.

— PRODUCTION TIME

Between 5 and 6 weeks after order confirmation. In any case, this is a just indicative and is not a binding for the manufacturer. Loading date for special orders, large quantities or with C.O.M. needs to be confirmed case by case.

Orders with C.O.M. delivery time starts to run once the fabric is physically in our warehouse.

NOTE: Any incident that occurs during transport must be reported within the 24 hours following reception. In the event of potential claims, the delivery note must state "merchandise pending inspection"

— TRANSPORT INCOTERMS: EXWORKS

1. Viccarbe will invoice the products within the 5 days following the date on which Viccarbe communicates to the client the products are at its disposal for their collection.

2. Additionally, Viccarbe will be entitled to invoice the client a fixed fee of 1.271 DKK a variable fee of a daily 1% of the total amount of the order that the client does not collect the products within seven (7) days after Viccarbe communicates the products are ready to be collected.

In case of air shipments, the material used to protect the product will be charged to the customer.

— IMPORTANT LOGISTICS PROCESS

Viccarbe offers two different procedures for orders deliveries:

1. Via seafreight. By container (20' / 40' / 40'HQ) or Groupage LCL. Normal packaging is used with loose cardboard boxes.

2. Via airfreight. There are 2 options, depending on the form / volume of the packaging.

2.a) Palletized: the models will be grouped in fumigated pallets (complying with ISPM-15 regulation). The price per pallet is ~~393~~ DKK unit. Please note that pallets are not stackable.

2.b) Wooden boxes: on request, special wooden boxes can be manufactured in order to group more items in the inside and send them stackable. The price of each wooden box will depend on the distribution and type of models purchased.

VERY IMPORTANT NOTE: in order to not delay the pick-up date, the client should notify the shipping option (sea or airfreight) at the moment of registering the order. Once the order is completed and the customer requests a change to air shipment not foreseen in the original registration, it may be delayed due to packaging (depending on the order

size) at most in 2 weeks.

— SPECIAL PACKAGING

Always under request and quotation to the factory.

— 10 YEAR WARRANTY

Viccarbe guarantees the product quality throughout all its manufacturing process and all products components when have had an adequate use for their specific characteristics.

Defects caused by negligence, knocks, inadequate cleaning products or climatic changes are not covered, neither changes caused by the environmental conditions.

Woods: All our polishes are protected against UV rays. However, prolonged exposure to direct sunlight can cause changes in the tone of wood. As wood is a natural material, this slight tone difference is part of its individuality and therefore may not be considered as a fault or returned for such reasons. To prevent any tone variation, we recommend avoiding leaving an object on the surface in a fixed position for a prolonged period. In addition, if products are purchased in different periods there might be a slight difference in wood tonality.

The guarantee is valid for 10 years from the date of the invoice of Viccarbe, except for Custom orders, Outdoor product and the following list of products: Trino, Burin Mini, Ryutaro, Tiers, Giro and Bamba; in which cases the warranty is 2 years.

During the term of the guarantee, the holder thereof shall be entitled to at least:

a) Total repair free of charge of the manufacturing defects and of the damaged resulting therefore.

b) In the event of unsatisfactory repairing and the object failed to be in optimum condition to fulfill the use on which it was intended, the holder of the guarantee shall be entitled to either the replacement of the object purchased by another product of identical characteristics or a full price refund.

Summary

Standard order

The placing of an order is made by e-mail, indicating the complete description of the models.

Order confirmation

Once the order is received and confirmed that we have all the correct data, the order confirmation is sent to the customer by e-mail within 48 hours (working days).

Payment

Payment terms and conditions will be agreed upon individually. The first order will be paid 100% in advance.

Production

5 weeks production after the order confirmation.

Delivery

Custom Orders

All orders need to be received in written to e-mail, containing the list of products and their specific finishes.

Project Management

Our project management team works with architects, interior designers and customers to help develop the design and create products customised to fit particular requirements for specific projects.

Order confirmation

Once the order is received and confirmed that we have all the correct data, the order confirmation is sent to the customer by e-mail within 48 hours (working days).

Payment

Orders will not be processed until confirmation and acceptance are received in writing for more than 100% of the total amount in advance

Production

Delivery

10 weeks production minimum (approximately) after the order confirmation. It depends on the difficulty of manufacturing the piece and will be indicated in writing with the quote.

GRADE IN & FAST TRACK

The fabrics used are of the highest quality and have been tested beforehand; however, they cannot be formally guaranteed, especially with regard to variations in shade that may exist with respect to the sample book or between products delivered at different times, and it is therefore impossible for us to guarantee a perfect match between the coating of an original composition and the elements added later.

The length indicated is indicative for a fabric width of 1.4 m. In the case of skins (C.O.L), to calculate the square metres required please contact the Sales Team.

The tolerance in the measurements of the upholstered elements may be +/- 3 cm.

— CAMIRA STAY SAFE

As a new feature, we now offer the option to include Camira Stay Safe treatment on certain fabrics. This is an advanced textile treatment that reduces the potential for viral transmission from fabric surfaces in commercial spaces and any interior. When applied to a fabric, this textile technology destroys viruses and kills bacteria, ensuring the upholstery does not act as a potential source of transmission.

In a world where hygiene and health are today's top priorities, Camira StaySafe can help create safer indoor spaces by providing a higher level of protection against viruses and bacteria. It is perfect for multi-purpose furniture: in waiting areas, public transport vehicles, breakout spaces, restaurants, hotels, educational environments, residences and many more. The treatment can be applied to the following fabrics:

URBAN, ERA, BLAZER

Please contact our sales department for a quotation and further information.

— UPHOLSTERED WITH CUSTOMER'S FABRIC

They may be supplied at the price indicated in the customer fabric category (G1), but the fabrics must arrive at our factory carriage paid. Any costs incurred by the customer fabric will be charged on the invoice. Customer fabric warning:

- The customer fabric must be validated by Viccarbe's technical department before being put into production. For this purpose, a 20x20 cm sample of each of the customer fabrics must be sent.
- Please indicate the order reference number and the product to which the customer fabrics correspond.
- The order will not be put into production until the fabric has been received by Viccarbe.
- Viccarbe will not be responsible in any case for any incidence on the product derived directly or indirectly from the selection of a client's fabric. The client will assume the responsibility and guarantee of a good selection of fabric that meets the minimum requirements of quality, resistance, abrasion, colour change, pilling, fire resistance regulations or any other characteristic of the fabric that may cause an incident or complaint about the product.

Standard Fabrics selection NEW

A curated selection of fabrics available as standards, stocked in Spain, for the fastest delivery under our fast track program. Now available a collection of fabrics in stock that guarantee a shorter lead time on all upholstery products and provides guidance of the best-performing ranges.

For large-scale projects please contact the Sales Team



All available sample collections and colours can be consulted on **page 510** or in the Professional Area in our web **pro.viccarbe.com**

The different finishes in terms of fabric qualities will be grouped into the following groups (always for a fabric width of 1.40 m):

camira		G1 ERA 45 PROMP		G1 ERA 31 SPLITSECOND		G1 ERA 29 EXPERIENCIE		G1 ERA 19 CALENDAR		
		G2 MAIN LINE FLAX Archway MLF02		G2 MAIN LINE FLAX Camdem MLF26		G2 MAIN LINE FLAX Upmister MLF20		G2 MAIN LINE FLAX Monument MLF09		
crevin		G1 DUO 4		G1 DUO 50		G1 URUS 8		G2 GAUDI 05		G2 GAUDI 11
	kvadrat		G2 REMX 3 123		G2 REMX 3 143		G2 REMX 3 242		G2 REMX 3 612	
		G3 CANVAS 2 734		G3 CANVAS 2 124		G3 CANVAS 2 836		G3 CANVAS 2 996		
		G4 STEELCUT TRIO 3 883		G4 STEELCUT TRIO 3 713		G4 STEELCUT TRIO 3 453		G4 STEELCUT TRIO 3 213		
		G5 HALLINGDALL 65 220		G5 HALLINGDALL 65 407		G5 HALLINGDALL 65 130		G5 HALLINGDALL 65 180		
		G5 DIVINA MELANGE 3 617		G5 DIVINA MELANGE 3 457		G5 DIVINA MELANGE 3 527		G5 DIVINA MELANGE 3 237		
Gabriel		G1 FELICITY 63089		G1 FELICITY 61164		G1 FELICITY 67079				
		G2 MEDLEY 61189		G2 MEDLEY 61003		G2 MEDLEY 62054		G2 MEDLEY 63063		G2 MEDLEY 66010
		G2 STEP 61149		G2 STEP 60004		G2 STEP 68165		G2 STEP 68158		
		G2 STEP MELANGE 61104		G2 STEP MELANGE 60004		G2 STEP MELANGE 62057		G2 STEP MELANGE 68158		

The selection of *Graded In* fabrics are approved by our upholstery experts to ensure that all our upholstered products perform well. These fabrics are of the highest performance and meet the strictest quality standards. They are backed by the best upholstery textile manufacturers in the sector. We offer the full range of colours in each of the collections available to adapt to each project. Remember that a careful selection of some of these colours is available in the Fast Track catalogue, with a shorter delivery time than the *Graded In* catalogue.

All available sample collections and colours can be consulted on **page 510** or in the Professional Area in our web

pro.viccarbe.com

The different finishes in terms of fabric qualities will be grouped into the following groups (always for a fabric width of 1.40 m):

camira

G1: URBAN, CITADEL, ERA

G2: MAIN LINE FLAX

G3: BLAZER

crevin

G1: DUO, URUS

G2: GAUDI, FUSION, MATISS

G3: ARC, BORA-BORA

kvadrat

G1: -

G2: REMIX 3

G3: MAPLE, CANVAS 2

G4: FIORD 2, STEELCUT TRIO 3, HERO 2, MELANGE NAP

G5: HALLINGDAL 65, DIVINA MELANGE 3, DIVINA MD

Gabriel*

G1: FELICITY, TONAL, ATLANTIC, CURA

G2: MEDLEY, STEP, STEP MELANGE

G3: FAME, FAME-HYBRID, GAJA 2C2

G4: CRISP, CAPTURE

G5: -

SPRADLING®

G1: VALENCIA VINYL

Textaafoam

G1: SEVEN (VELVET)

ANTIC CUIR

G5: ANTIC CUIR LEATHER SERIE 100

The production times indicated are subject to the existence in stock of the selected colour and model of fabric. Although it is not usual for fabrics to be out of stock, it is recommended that you confirm the availability of the fabric with the sales department before placing your order.

About the product

COLOR RANGE - LACQUERED WOODS

GROUP 1

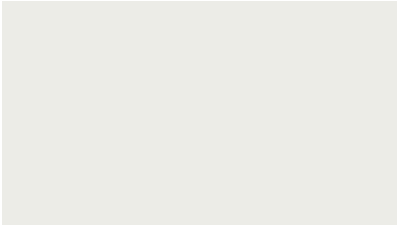

White | RAL 9003



Black | RAL 9005

GRUPO 2



Taupe | RAL 1019



Brick | RAL 050 50 30



Ochre | RAL 1011



Olive Green | RAL 090 40 30



Dusty Pink | RAL 060 70 20



Dusty Green | RAL 7034

GROUP 3

FLUORESCENT



Bronze



Fluorescent Orange | RAL 2005

COLOR RANGE - LACQUERED METALS

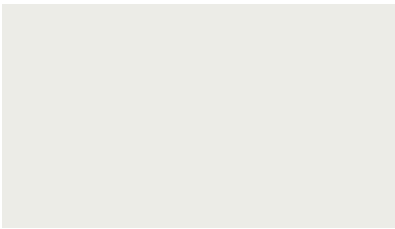

White | RAL 9003



Black | RAL 9005



Taupe | RAL 1019

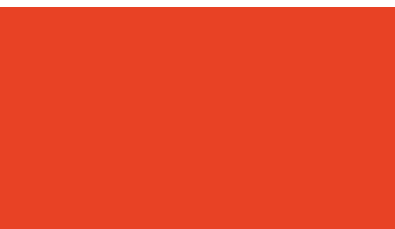

Fluorescent Orange | RAL 2005



Brass finish

COLOR RANGE - POLYPROPYLENES

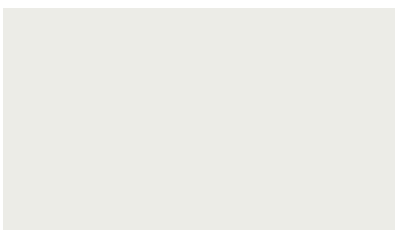

White | RAL 9003

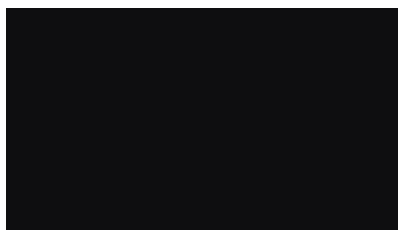

Black | RAL 9005



Taupe | RAL 1019



Brick | RAL 050 50 30



Ochre | RAL 1011



Dusty Green | RAL 7034

Test Certificates for the finishes: UNE 89401

COLOR RANGE - POLYETHYLENES

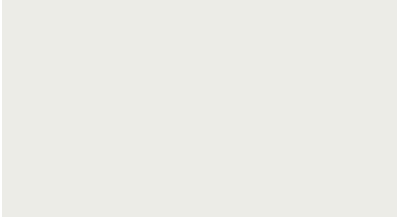

White | RAL 9003

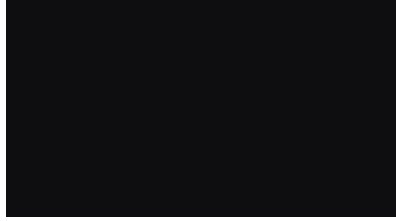

Black | RAL 9005



Taupe | RAL 1019

STAINED WOODS



Matt stained oak

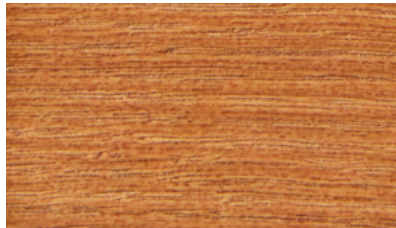

Cognac stained oak

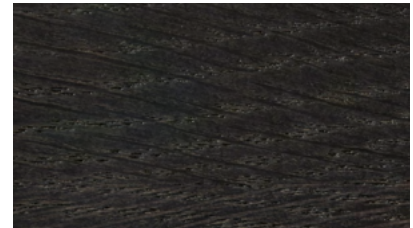

Ash stained oak



White stained oak (open pore)



Bleached stained oak *NEW*

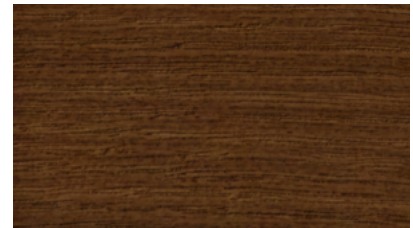

Walnut stained oak *NEW*

TECHNICAL FABRICS

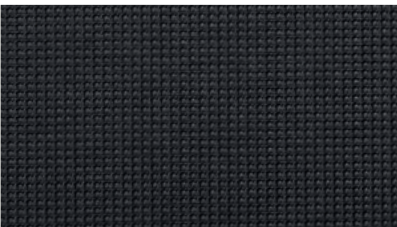

Dark grey

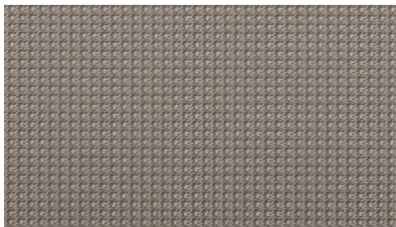

Light grey

OTHER MATERIALS

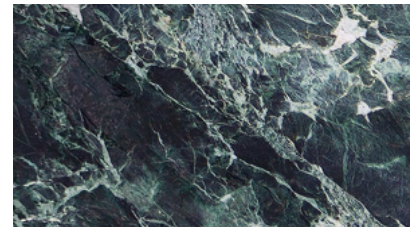

Marble | Indian Green

Only available for the protective band of SEASON SOFA and SEASON CHAIR

Only available for the sphere model of the low table TRINO

TABLETOPS

The thickness of these images does not correspond to the thickness of each board (which depends on each model).



Matt stained oak
stained MDF core



Cognac stained oak
stained MDF core



Ash stained oak
stained MDF core



Bleached stained oak *NEW*
núcleo de MDF pulimentado



Walnut stained oak *NEW*
núcleo de MDF pulimentado

COMPACT



Compact laminate,
black core

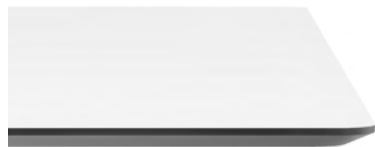

Compact laminate,
black core

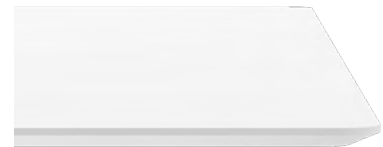

Compact laminate,
white core

HPL with MDF



Black HPL with MDF | Soft Touch by FENIX
stained core



White HPL with MDF,
stained core

LACQUERED



Lacquered MDF
Available in all colours of our collection

MELAMINE



Black melamine
black edging

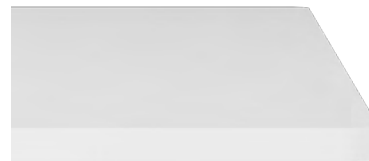

White melamine
White edging

CHAIRS AND STOOLS



Ears

BY PIERO LISSONI

Pg. 38

From 2.704 DKK



Funda

BY STEFAN DIEZ

Pg. 48

From 3.432 DKK



Quadra

BY MARIO FERRARINI

Pg. 52

From 3.110 DKK



Copa

BY RAMOS & BASSOLS

Pg. 56

From 3.992 DKK



Aleta

BY JAIME HAYON

Pg. 74

From 4.204 DKK



Maarten Plastic

BY VICTOR CARRASCO

Pg. 94

From 1.356 DKK

CHAIRS AND STOOLS



Maarten

BY VÍCTOR CARRASCO

Pg. 94

From 2.602 DKK



Season Chair

BY PIERO LISSONI

Pg. 136

From 5.034 DKK



Klip

BY VÍCTOR CARRASCO

Pg. 138

From 2.026 DKK



Last Minute

BY PATRICIA URQUIOLA

Pg. 186

From 2.331 DKK

LOUNGE CHAIRS



Zoco *NEW*

BY VICTOR CARRASCO

Pg. 188

—
From 4.916 DKK*



Funda Bold *NEW*

BY STEFAN DIEZ

Pg. 190

—
From 14.068 DKK



Sistema Legs Lounge

BY LIEVORE ALTHERR MOLINA

Pg. 244

—
From 10.568 DKK



Sistema Floor Lounge

BY LIEVORE ALTHERR MOLINA

Pg. 244

—
From 7.060 DKK



Step Lounge

BY VINCENT VAN DUYSSEN

Pg. 296

—
From 11.585 DKK



Savina Lounge

BY VICTOR CARRASCO

Pg. 226

—
From 18.586 DKK

LOUNGE CHAIRS



Funda Lounge

BY STEFAN DIEZ

Pg. 194

—
From 6.755 DKK



Copa Lounge

BY RAMOS & BASSOLS

Pg. 196

—
From 5.602 DKK



Nagi

BY TOMOYA TABUCHI

Pg. 198

—
From 10.492 DKK



Ace

BY JEAN-MARIE MASSAUD

Pg. 202

—
From 9.543 DKK



Maarten Lounge

BY VICTOR CARRASCO

Pg. 206

—
From 5.560 DKK



Aleta Lounge

BY JAIME HAYON

Pg. 210

—
From 8.670 DKK

LOUNGE CHAIRS



Brix

BY KENSAKU OSHIRO

Pg. 214

—
From 8.975 DKK



Wrapp

BY MARC KRUSIN

Pg. 218

—
From 9.348 DKK



Colubi

BY RT DESIGN

Pg. 220

—
From 7.738 DKK



Fedele

BY VICTOR CARRASCO

Pg. 222

—
From 7.424 DKK



Penta

BY TOAN NGUYEN

Pg. 224

—
From 7.424 DKK



Levitt

BY L+R PALOMBA

Pg. 306

—
From 11.162 DKK

SOFAS



Savina

BY VICTOR CARRASCO

Pg. 226

From 10.975 DKK/module



Sistema Legs

BY LIEVORE ALTHERR MOLINA

Pg. 244

From 19.086 DKK



Sistema Floor

BY LIEVORE ALTHERR MOLINA

Pg. 244

From 7.060 DKK/module



Season Sofa

BY PIERO LISSONI

Pg. 288

From 10.594 DKK/module



Step

BY VINCENT VAN DUYSSEN

Pg. 296

From 7.738 DKK/module



Levitt

BY L+R PALOMBA

Pg. 306

From 16.238 DKK

BENCHES



Season

BY PIERO LISSONI

Pg. 312

From 16.967 DKK



Torii

BY L+R PALOMBA

Pg. 316

From 9.450 DKK



Sistema Bench

BY LIEVORE ALTHERR MOLINA

Pg. 326

From 4.822 DKK/module



Trestle

BY JOHN PAWSON

Pg. 334

From 10.382 DKK



Common

BY NAOTO FUKASAWA

Pg. 342

From 10.331 DKK/module



Season Pouf

BY PIERO LISSONI

Pg. 354

From 3.170 DKK

TABLES



Trivio *NEW*

BY JASPER MORRISON

Pg. 360

From 6.738 DKK*

*Available from 2 May 2023



Foro *NEW*

BY JOHN PAWSON

Pg. 364

From 22.120 DKK

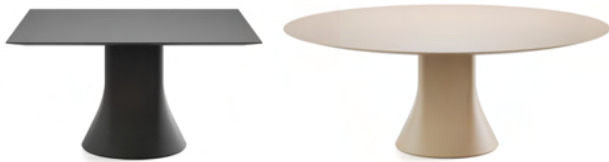

Cambio

BY VICTOR CARRASCO

Pg. 374

From 3.110 DKK



Solar

BY MARC KRUSIN

Pg. 394

From 5.687 DKK



Maarten

BY VICTOR CARRASCO

Pg. 400

From 5.187 DKK



Burin

BY PATRICIA URQUIOLA

Pg. 426

From 3.458 DKK

TABLES



Trestle

BY JOHN PAWSON

Pg. 444

From 12.712 DKK



Stan

BY VCCB STUDIO

Pg. 468

From 4.305 DKK

LOW TABLES



Cambio Low Table

BY VÍCTOR CARRASCO

Pg. 374

From 3.068 DKK



Trino

BY ELISA OSSINO

Pg. 476

From 2.390 DKK



Burin Mini

BY PATRICIA URQUIOLA

Pg. 478

From 4.051 DKK



Aleta Low Table

BY JAIME HAYON

Pg. 480

From 4.593 DKK



Ryutaro

BY VÍCTOR CARRASCO

Pg. 484

From 2.492 DKK



Shape

BY JORGE PENSI

Pg. 486

From 5.144 DKK

LOW TABLES



Tiers

BY PATRICIA URQUIOLA

Pg. 488

—
From 3.992 DKK



Serra

BY VICTOR CARRASCO

Pg. 490

—
From 2.127 DKK



Holy Day Table

BY JEAN-MARIE MASSAUD

Pg. 492

—
From 3.848 DKK*

*Available until 18 December 2023



Common

BY NAOTO FUKASAWA

Pg. 342

—
From 4.110 DKK



Maarten Low Table

BY VICTOR CARRASCO

Pg. 400

—
From 4.678 DKK



Stan Low Table

BY VCCB STUDIO

Pg. 468

—
From 4.051 DKK

LOW TABLES



Giro

BY PEDRO PAULO-VENZON

Pg. 494

—
From 5.297 DKK



Bamba

BY PEDRO PAULO-VENZON

Pg. 496

—
From 4.153 DKK



Up in the Air

BY RAMÓN UBEDA Y OTTO CANALDA

Pg. 498

—
From 16.814 DKK*

*Available until 18 December 2023

ACCESSORIES



Window

BY VINCENT VAN DUYSSEN

Pg. 500

From 2.814 DKK



Keel

BY VICTOR CARRASCO

Pg. 502

From 1.712 DKK*

*Available until 18 December 2023

Products



Ears

BY PIERO LISSONI

VICCARBE · Price List 2023 EXW

V02 Jun

CHAIRS AND STOOLS

The new chair by the versatile Piero Lissoni joins the collection with the soul of a true icon. Ears is as light in terms of materials as it is resistant to aging. Its sinuous shapes keep intact a style capable of taking us back in time to the contemporary classics of the 70s.

Its balanced arrangement (as reduced as it is comfortable) makes Ears a perfect option for different collective and private areas: meeting points, cafeterias, auditoriums, waiting rooms, educational spaces, work areas in libraries or lounges.

It is possible to choose oak wood finishes for the entire product, as well as combining its oak seat and metal structure. Both versions of the chair can be complemented with distinctive armrests, designed to embrace the user.

This new chair designed by the Italian architect means going back to the roots of industrial design, a tribute to the shapes and materials that so inspired Viccarbe's beginnings in the furniture industry.

SEAT OPTIONS

Stained

Stained curved oak plywood seat.

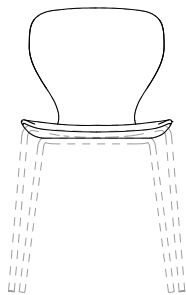

Combined

Stained curved oak plywood seat with cushion.

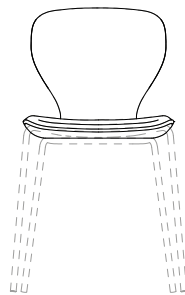

Smooth upholstery

Smooth upholstered plywood seat covered with expanded polyurethane foam.

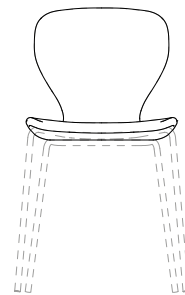

CHAIR BASE OPTIONS

Four metal legs

Calibrated steel structure powder coated in thermoreinforced polyester in white or black. Plastic glides in black or white with or without felt.

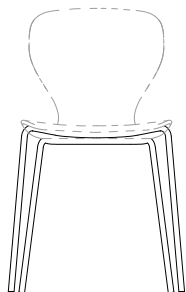

Four wooden legs

Curved legs in natural oak plywood with the finishes of our collection and white (open pore). Plastic glides in white or black.

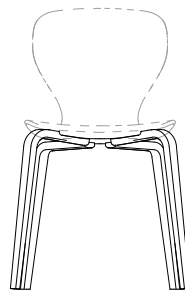

Four upholstered wooden legs

Curved legs in natural oak plywood upholstered in leather or ecoleather. Plastic glides in white or black.

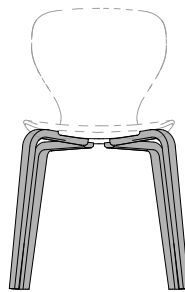

x10
Stackable up to
10 units.

Ears Chair

2020, BY PIERO LISSONI

CHAIRS AND STOOLS

STOOL BASE OPTIONS

Four metal legs Counter stool

Calibrated steel structure powder coated in thermoreinforced polyester in white or black. Plastic glides in black or white with or without felt.

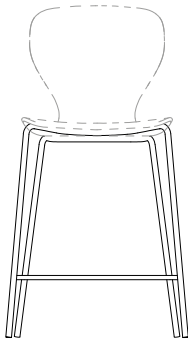

Four metal legs Bar stool

Calibrated steel structure powder coated in thermoreinforced polyester in white or black. Plastic glides in black or white with or without felt.

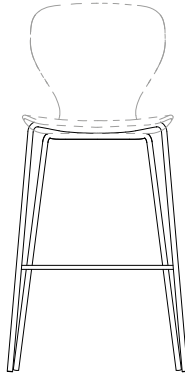

ACCESSORIES

Side table

HPL sidetable with aluminum mechanism and anti-panic system. Left or right versions. Available only for four metal legs base.

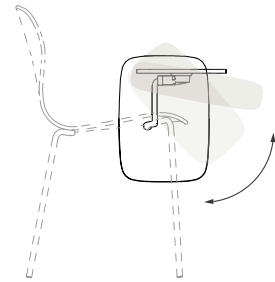

ARM OPTIONS

Metal armrest

Calibrated steel arms powder coated in thermoreinforced polyester in black or white. Available for all bases and seats. Not stackable with arms.

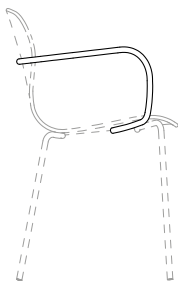

Metal with solid wood armrest

Calibrated steel arms powder coated in thermoreinforced polyester in black or white with natural wood armrests stained with the finishes of our collection and white (open pore). Available for all bases and seats. Not stackable with arms.

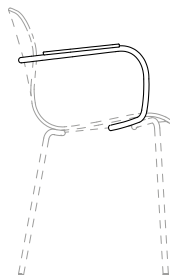

Upholstered metal armrest

Calibrated steel arms powder coated in thermoreinforced polyester in black or white pholstered with leather or ecoleather. Available for all bases and seats. Not stackable with arms.

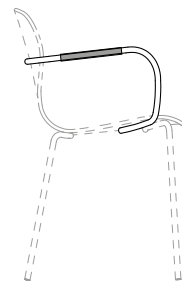

CHAIRS AND STOOLS

Test certificates: ANSI/BIFMA X5.4:2020 and UNE-EN 16139:2013vc2015
(without arms and with side table)

Calibrated steel structure powder coated in thermoreinforced polyester in white or black. Black or white plastic glides with or without felt.*
Stackable up to 10 units for the non-upholstered version and 4 units for the upholstered versions.

NOTE: Due to the fact that the wood used is natural, the finish may vary.

Needed fabric for material
1.40 m wide:
Cushion: 0.7 m
Smooth upholstery: 1.25 m

FOUR LEGS METAL BASE

Stained

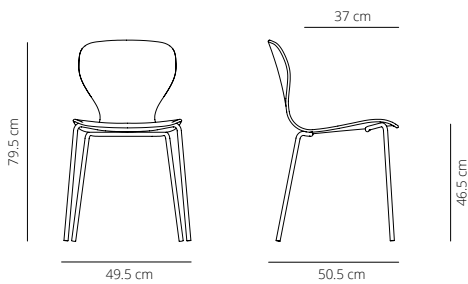

14.1 kg

(x1) 56x55x100 cm (0.31 m³)

x10 Stackable up to 10 units

The package contains 2 units

CODE	FINISHES		PUBLIC PRICE
	STRUCTURE	SEAT	
EA4PRO	white or black	matt oak, cognac, ash, white open pore, bleached oak or walnut	2.704 DKK

NOTE: Price per unit.

Stained with cushion

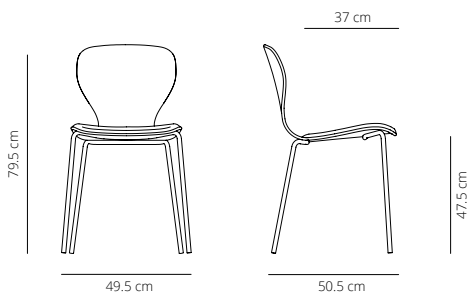

8.4 kg

(x1) 56x55x85 cm (0.26 m³)

x4 Stackable up to 4 units

CODE	FINISHES			PUBLIC PRICE
	STRUCTURE	SEAT	UPHOLSTERY	
EA4PROC-1	white or black	matt oak, cognac, ash, white open pore, bleached oak or walnut	G1 (T/C)	3.365 DKK
EA4PROC-2			G2	3.475 DKK
EA4PROC-3			G3	3.636 DKK
EA4PROC-4			G4	3.848 DKK
EA4PROC-5			G5	4.051 DKK

Smooth upholstery

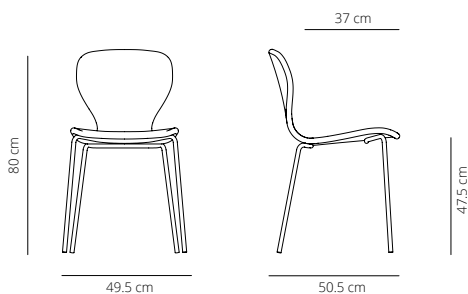

8.3 kg

(x1) 56x55x85 cm (0.26 m³)

x4 Stackable up to 4 units

CODE	FINISHES		PUBLIC PRICE
	STRUCTURE	UPHOLSTERY	
EA4PT-1	white or black	G1 (T/C)	3.737 DKK
EA4PT-2		G2	4.051 DKK
EA4PT-3		G3	4.610 DKK
EA4PT-4		G4	5.085 DKK
EA4PT-5		G5	5.560 DKK

+ 4€ 

*Felt glides available with an upcharge of 4€. If not indicated, the chair will be produced with plastic glides.

Ears Chair

2020, BY PIERO LISSONI

CHAIRS AND STOOLS

Curved legs in natural oak plywood with the finishes of our collection and white (open pore).
Plastic glides in white or black.

Needed fabric for material
1.40 m wide:
Cushion: 0.7 m
Smooth upholstery: 1.25 m

NOTE: Due to the fact that the wood used is natural, the finish may vary.

FOUR WOODEN LEGS BASE

Stained

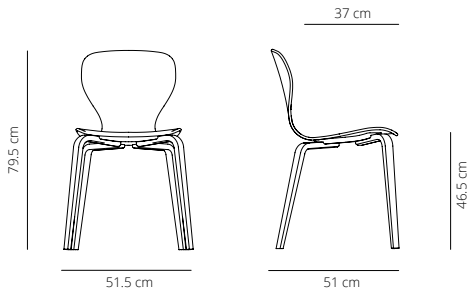

📦 6.4 kg
📦 (x1) 56x57x85 cm (0.27 m³)

CODE	FINISHES	PUBLIC PRICE
	STRUCTURE AND SEAT	
EA4PMRO	matt oak, cognac, ash, white open pore, bleached oak or walnut	3.737 DKK

Stained with cushion

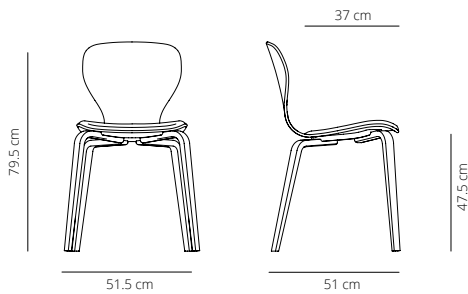

📦 7.1 kg
📦 (x1) 56x57x85 cm (0.27 m³)

CODE	FINISHES		PUBLIC PRICE
	STRUCTURE AND SEAT	UPHOLSTERY	
EA4PMROC-1	matt oak, cognac, ash, white open pore, bleached oak or walnut	G1 (T/C)	4.415 DKK
EA4PMROC-2		G2	4.568 DKK
EA4PMROC-3		G3	4.721 DKK
EA4PMROC-4		G4	4.932 DKK
EA4PMROC-5		G5	5.144 DKK

Smooth upholstery

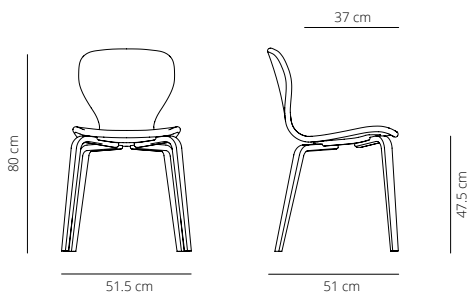

📦 7 kg
📦 (x1) 56x57x85 cm (0.27 m³)

CODE	FINISHES		PUBLIC PRICE
	STRUCTURE	UPHOLSTERY	
EA4PMT-1	matt oak, cognac, ash, white open pore, bleached oak or walnut	G1 (T/C)	5.238 DKK
EA4PMT-2		G2	5.509 DKK
EA4PMT-3		G3	5.924 DKK
EA4PMT-4		G4	6.331 DKK
EA4PMT-5		G5	6.755 DKK

CHAIRS AND STOOLS

Curved legs in natural oak plywood upholstered in leather or ecoleather.
Plastic glides in white or black.

NOTE: Due to the fact that the wood used is natural, the finish may vary.

NOTE: In case of using leather, the finish may vary due to the fact that is a natural material.

Needed fabric for material
1.40 m wide:.
Cushion: 0.7 m
Smooth upholstery: 1.25 m

FOUR UPHOLSTERED WOODEN LEGS BASE

Stained

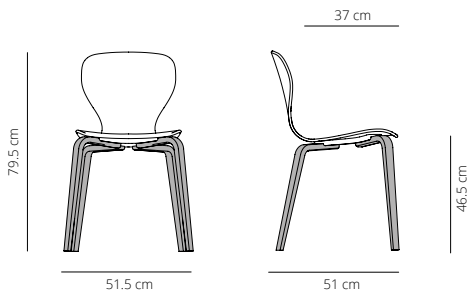

6.4 kg

(x1) 56x57x85 cm (0.27 m³)

CODE	FINISHES		PUBLIC PRICE
	STRUCTURE	SEAT	
EA4PTPRO	ecoleather	matt oak, cognac, ash, white open pore, bleached oak or walnut	5.399 DKK
EA4PTLRO	leather	matt oak, cognac, ash, white open pore, bleached oak or walnut	5.924 DKK

Stained with cushion

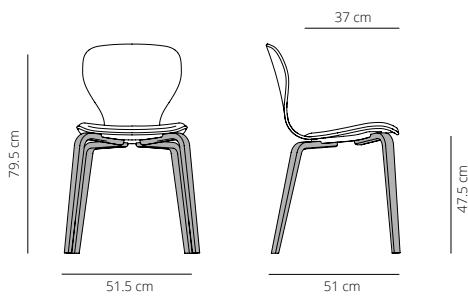

7.1 kg

(x1) 56x57x85 cm (0.27 m³)

CODE	FINISHES			PUBLIC PRICE
	STRUCTURE	SEAT	UPHOLSTERY	
EA4PTPROC-1	ecoleather	matt oak, cognac, ash, white open pore, bleached oak or walnut	G1 (T/C)	6.068 DKK
EA4PTPROC-2			G2	6.221 DKK
EA4PTPROC-3			G3	6.390 DKK
EA4PTPROC-4			G4	6.594 DKK
EA4PTPROC-5			G5	6.797 DKK
EA4PTLROC-1	leather	matt oak, cognac, ash, white open pore, bleached oak or walnut	G1 (T/C)	6.594 DKK
EA4PTLROC-2			G2	6.755 DKK
EA4PTLROC-3			G3	6.899 DKK
EA4PTLROC-4			G4	7.111 DKK
EA4PTLROC-5			G5	7.314 DKK

Smooth upholstery

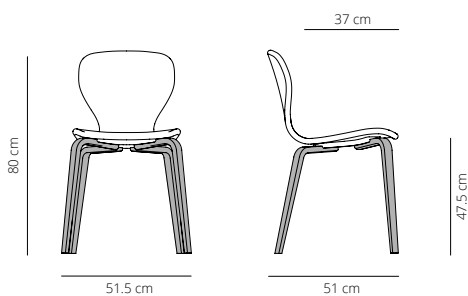

7 kg

(x1) 56x57x85 cm (0.27 m³)

CODE	FINISHES		PUBLIC PRICE
	STRUCTURE	UPHOLSTERY	
EA4PTPT-1	ecoleather	G1 (T/C)	6.899 DKK
EA4PTPT-2		G2	7.170 DKK
EA4PTPT-3		G3	7.577 DKK
EA4PTPT-4		G4	8.000 DKK
EA4PTPT-5		G5	8.416 DKK
EA4PTLT -1	leather	G1 (T/C)	7.424 DKK
EA4PTLT -2		G2	7.678 DKK
EA4PTLT -3		G3	8.102 DKK
EA4PTLT -4		G4	8.509 DKK
EA4PTLT -5		G5	8.924 DKK

Ears Chair

2020, BY PIERO LISSONI

CHAIRS AND STOOLS

Test certificates: UNE-EN 16139:2013vc2015 (without arms)

Calibrated steel structure powder coated in thermoreinforced polyester in white or black.

Black or white plastic glides with or without felt.*

NOTE: Due to the fact that the wood used is natural, the finish may vary.

Needed fabric for material
1.40 m wide:.

Cushion: 0.7 m

Smooth upholstery: 1.25 m

FIXED COUNTER STOOL BASE

Stained

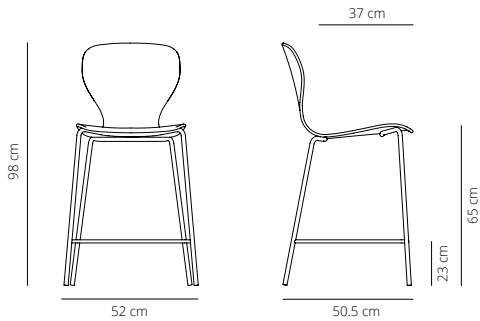

8.3 kg

(x1) 58x57x100 cm (0.33 m³)

Stained with cushion

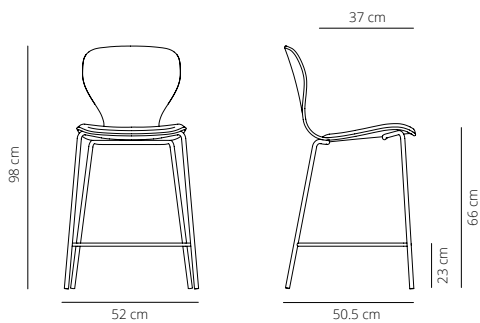

9.0 kg

(x1) 58x57x100 cm (0.33 m³)

Smooth upholstery

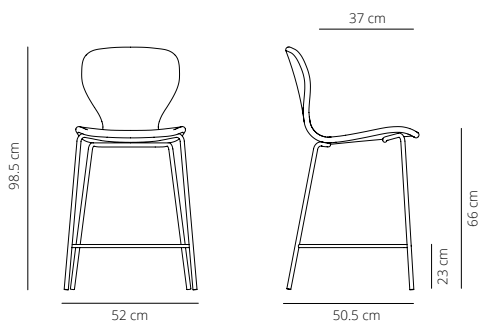

8.9 kg

(x1) 58x57x100 cm (0.33 m³)

CODE	FINISHES		PUBLIC PRICE
	STRUCTURE	SEAT	
EATC4PRO	white or black	matt oak, cognac, ash, white open pore, bleached oak or walnut	3.475 DKK

CODE	FINISHES			PUBLIC PRICE
	STRUCTURE	SEAT	UPHOLSTERY	
EATC4PROC-1	white or black	matt oak, cognac, ash, white open pore, bleached oak or walnut	G1 (T/C)	4.153 DKK
EATC4PROC-2			G2	4.254 DKK
EATC4PROC-3			G3	4.415 DKK
EATC4PROC-4			G4	4.678 DKK
EATC4PROC-5			G5	4.890 DKK

CODE	FINISHES		PUBLIC PRICE
	STRUCTURE	UPHOLSTERY	
EATC4PT-1	white or black	G1 (T/C)	4.314 DKK
EATC4PT-2		G2	4.678 DKK
EATC4PT-3		G3	5.144 DKK
EATC4PT-4		G4	5.653 DKK
EATC4PT-5		G5	6.136 DKK



+ 4€

*Felt glides available with an upcharge of 4€. If not indicated, the chair will be produced with plastic glides.

CHAIRS AND STOOLS

Test certificates: UNE-EN 16139:2013vc2015 (without arms)

Calibrated steel structure powder coated in thermoreinforced polyester in white or black.

Black or white plastic glides with or without felt.*

NOTE: Due to the fact that the wood used is natural, the finish may vary.

Needed fabric for material
1.40 m wide:.

Cushion: 0.7 m

Smooth upholstery: 1.25 m

FIXED BAR STOOL BASE

Stained

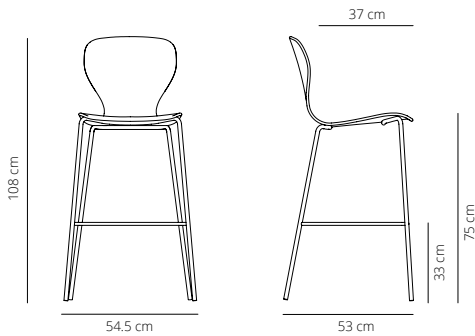

8.8 kg

(x1) 58x57x115 cm (0.38 m³)

Stained with cushion

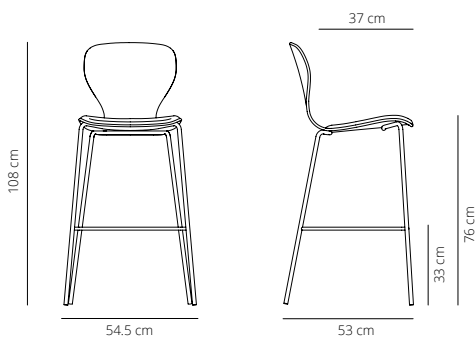

9.5 kg

(x1) 58x57x115 cm (0.38 m³)

Smooth upholstery

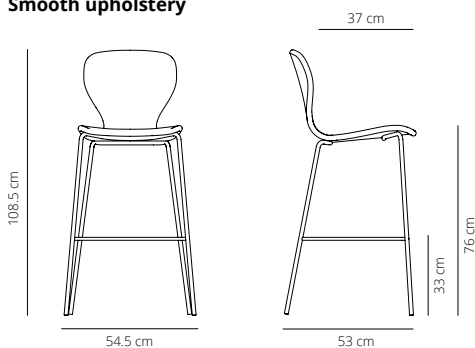

9.4 kg

(x1) 58x57x115 cm (0.38 m³)

CODE	FINISHES		PUBLIC PRICE
	STRUCTURE	SEAT	
EATB4PRO	white or black	matt oak, cognac, ash, white open pore, bleached oak or walnut	3.475 DKK

CODE	FINISHES			PUBLIC PRICE
	STRUCTURE	SEAT	UPHOLSTERY	
EATB4PROC-1	white or black	matt oak, cognac, ash, white open pore, bleached oak or walnut	G1 (T/C)	4.153 DKK
EATB4PROC-2			G2	4.254 DKK
EATB4PROC-3			G3	4.415 DKK
EATB4PROC-4			G4	4.678 DKK
EATB4PROC-5			G5	4.890 DKK

CODE	FINISHES		PUBLIC PRICE
	STRUCTURE	UPHOLSTERY	
EATB4PT-1	white or black	G1 (T/C)	4.314 DKK
EATB4PT-2		G2	4.678 DKK
EATB4PT-3		G3	5.144 DKK
EATB4PT-4		G4	5.653 DKK
EATB4PT-5		G5	6.136 DKK

+ 4€ 

*Felt glides available with an upcharge of 4€. If not indicated, the chair will be produced with plastic glides.

ACCESSORIES

Metal armrest

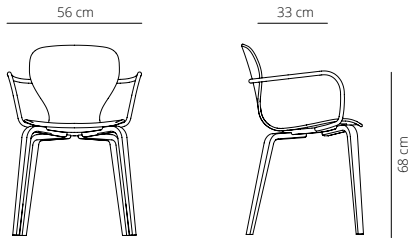

- 1.4 kg
- Included and fitted on the chair

CODE	FINISHES	PUBLIC PRICE
	STRUCTURE	
EABR	white or black	780 DKK

Calibrated steel arms powder coated in thermoreinforced polyester in black or white.
Available for all bases and seats. Not stackable with arms.

Metal with solid wood armrest

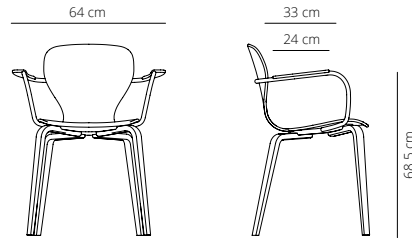

- 1.6 kg
- Included and fitted on the chair

CODE	FINISHES		PUBLIC PRICE
	STRUCTURE	STAINED	
EABRM	white or black	matt oak, cognac, ash, white open pore, bleached oak or walnut	1.653 DKK

Calibrated steel arms powder coated in thermoreinforced polyester in black or white with natural wood armrests stained with the finishes of our collection and white (open pore).
Available for all bases and seats. Not stackable with arms.

Upholstered metal armrest

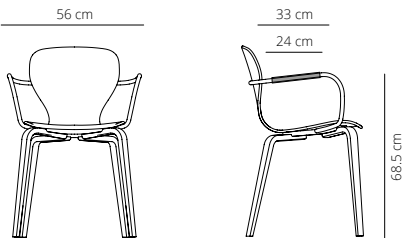

- 1.4 kg
- Included and fitted on the chair

CODE	FINISHES		PUBLIC PRICE
	STRUCTURE	UPHOLSTERY	
EABRTP	white or black	ecoleather	1.246 DKK
EABRTL		leather	1.246 DKK

Calibrated steel arms powder coated in thermoreinforced polyester in black or white and upholstered with leather or ecoleather.
Available for all bases and seats. Not stackable with arms.

ACCESSORIES

Writing tablet

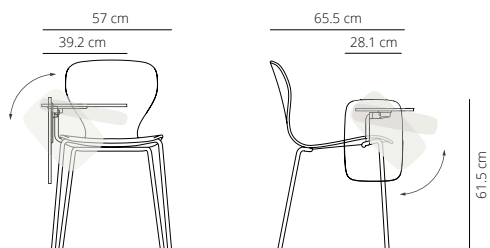

- 📦 2.2 kg
- 📦 Included and fitted on the chair

CODE	FINISHES		PUBLIC PRICE
	STRUCTURE	WRITING TABLET	
EA4-PALAD	white or black	black	881 DKK
EA4-PALAI			881 DKK

HPL tablet with aluminum mechanism and anti-panic system. Left or right handed versions available. Available only for four metal legs base.

NOTE: Structures of the sidetable and the chair are always in the same color.



PALA D
right handed



PALA I
left handed

IMPORTANT INFORMATION:
The writing tablet has options for right and left handed people.
Take in count the code for each version when making the order.

Trolley

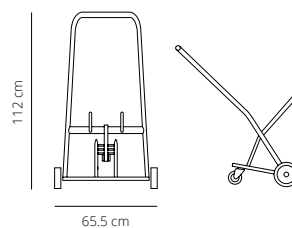

- 📦 8.2 kg
- 📦 (x1) 69.5x89x89 cm (0.55m3)

 x10 The transport is possible for a maximum of 10 chairs simultaneously.

CODE	FINISHES	PUBLIC PRICE
EACT	black	3.737 DKK

Available to transport stackable chairs. Trolley lacquered in black.



Funda

BY STEFAN DIEZ

CHAIRS AND STOOLS

The commitment to maximum sustainability and comfort shapes Funda, a new range of seats conceived by the outstanding designer Stefan Diez under the umbrella of creating an innovative and light chair. Funda means "cover" in Spanish.

This new collection is presented as a construction made up of two differentiated pieces that, thanks to its shape, simulate the gesture of two hands which embrace the user. The development of Funda has been based on combining a metal structure designed to last over time, and an upholstered seat that can be replaced after years of use or severe wear and tear.

In this case we simplify the usual components of a chair (structure, seat, fabrics) to structure and upholstery, without losing its resistance and comfort.

Test certificates: ANSI/BIFMA X5.4-2020 and UNE-EN 16139:2013vc2015

Four legs base of calibrated steel tube powder coated in thermoreinforced polyester in white and black.
Internal frame for the seat and back of calibrated steel tube powder coated in thermoreinforced polyester covered with shape-holding expanded polyurethane foam.
Fabric or leather upholstery with the finishes of our collection.
Plastic glides.

Funda represents the balance between precision and the human-centered approach of Stefan Diez. His constant search for both industrial innovation and visual appeal has achieved in this collection a curved and friendly shape, combined with an upholstery known for its wrinkles.

In this way, Funda manages to evoke the maximum expression of comfort and makes available the different pieces of the range to all types of environments: restoration projects, homes, intermediate spaces and office

Needed fabric for material:
1.50 m wide:
Upholstery: 1.75 m

FOUR LEGS CHAIR BASE

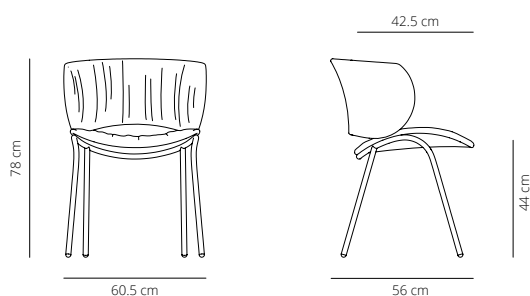

 7.7 kg

 (x1) 66x62x85 cm (0.35 m³)

CODE	FINISHES		PUBLIC PRICE
	STRUCTURE	UPHOLSTERY	
FUS-1	black or white	G1 (T/C)	4.890 DKK
FUS-2		G2	5.449 DKK
FUS-3		G3	6.136 DKK
FUS-4		G4	6.848 DKK
FUS-5		G5	7.678 DKK

Funda Chair

2020, BY STEFAN DIEZ

CHAIRS AND STOOLS

Test certificates: ANSI/BIFMA X5.4-2020 and UNE-EN 16139:2013vc2015

Needed fabric for material:
1.40 m wide:
Upholstery: 0.70 m

Four legs counter or bar base of calibrated steel tube powder coated in thermoreinforced polyester in white and black with footrest in the same colour.

Internal frame for the seat of calibrated steel tube powder coated in thermoreinforced polyester covered with shape-holding expanded polyurethane foam.

Fabric or leather upholstery with the finishes of our collection.
Plastic glides.

FIXED COUNTER STOOL BASE

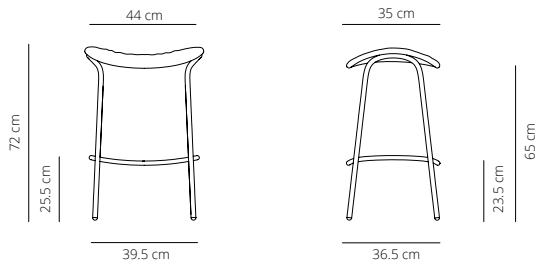

6.5 kg

(x1) 51x45x72 cm (0.17 m³)

CODE	FINISHES		PUBLIC PRICE
	STRUCTURE	UPHOLSTERY	
FUTC-1	black or white	G1 (T/C)	3.432 DKK
FUTC-2		G2	3.687 DKK
FUTC-3		G3	3.848 DKK
FUTC-4		G4	3.992 DKK
FUTC-5		G5	4.153 DKK

FIXED BAR STOOL BASE

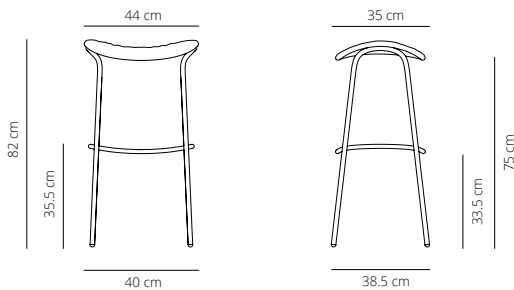

7.5 kg

(x1) 51x45x87 cm (0.20 m³)

CODE	FINISHES		PUBLIC PRICE
	STRUCTURE	UPHOLSTERY	
FUTB-1	black or white	G1 (T/C)	3.432 DKK
FUTB-2		G2	3.687 DKK
FUTB-3		G3	3.848 DKK
FUTB-4		G4	3.992 DKK
FUTB-5		G5	4.153 DKK



Quadra

BY MARIO FERRARINI

CHAIRS AND STOOLS

Test certificates: UNE-EN 16139:2013vc2015

Quadra has been originated as a tribute to the delicate details, lines, and tools of architectural drawing.

It is a convenient option for projects that require excellent functionality and durability over time (educational spaces, coffee shops, meeting

rooms, homes...), and can additionally be stacked in large quantities. Calibrated steel structure powder coated in thermoreinforced polyester in black or white.

Curved oak plywood stained in the finishes of our collection and white open pore. Black plastic glides with or whitout felt* or white plastic glides.

Chair

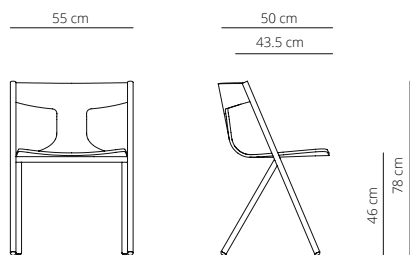

9.2 kg

(x1) 52x52x84 cm (0.23 m³)

CODE	FINISHES		PUBLIC PRICE
	STRUCTURE	SEAT	
QUARO	black or white	matt oak, cognac, ash, white open pore, bleached oak or walnut	3.110 DKK

Stackable chair

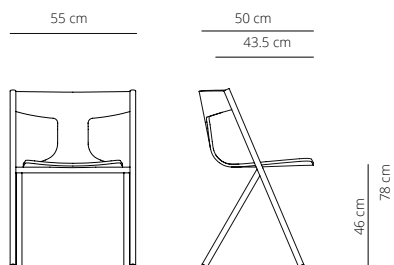

14.9 kg

(x1) 59x50.3x89 cm (0.28 m³)

x10 Stackable up to 10 units.

x2 Package contains 2 units.

CODE	FINISHES		PUBLIC PRICE
	STRUCTURE	SEAT	
QUAROA	black or white	matt oak, cognac, ash, white open pore, bleached oak or walnut	3.110 DKK

NOTE: Price per unit. Minimum order of two units.

Needed fabric for material:
1.40 m wide:
Cushion: 0.7 m

Chair with cushion

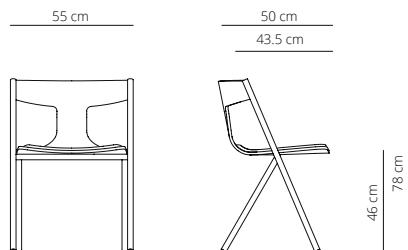

9.2 kg

(x1) 52x52x84 cm (0.23 m³)

CODE	FINISHES			PUBLIC PRICE
	STRUCTURE	SEAT	CUSHION	
QUAROC-1	black or white	matt oak, cognac, ash, white open pore, bleached oak or walnut	G1 (T/C)	3.898 DKK
QUAROC-2			G2	4.254 DKK
QUAROC-3			G3	4.721 DKK
QUAROC-4			G4	5.187 DKK
QUAROC-5			G5	5.712 DKK



+ 4€ *Black felt glides for black structure available with an upcharge of 4€. If not indicated, the chair will be produced with black plastic glides.

Needed fabric for material:
1.40 m wide:
Backrest: 0.4 m
Cushion: 0.7 m

Chair with cushion and upholstered backrest

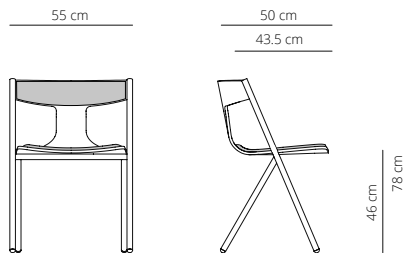

9.2 kg
(x1) 52x52x84 cm (0.23 m³)

CODE	FINISHES			PUBLIC PRICE
	STRUCTURE	SEAT	UPHOLSTERY	
QUAROCR-1	black or white	matt oak, cognac, ash, white open pore, bleached oak or walnut	G1 (T/C)	4.526 DKK
QUAROCR-2			G2	4.890 DKK
QUAROCR-3			G3	5.348 DKK
QUAROCR-4			G4	5.814 DKK
QUAROCR-5			G5	6.331 DKK

NOTE: This model can be ordered with two different upholstery colour finishings, being possible to change the colour of the backrest and the seat separately. In that case, always consider the highest category price.

+ 4€  *Black felt glides for black structure available with an upcharge of 4€. If not indicated, the chair will be produced with black plastic glides.

ACCESSORIES

Trolley

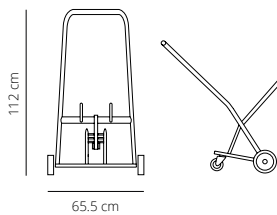

8.2 kg
(x1) 69.5x89x89 cm (0.55m³)

 x10 The transport is possible for a maximum of 10 chairs simultaneously.

CODE	FINISHES	PUBLIC PRICE
QUACT	black	3.737 DKK

Available to transport stackable chairs.
Trolley lacquered in black.

Linking device for chairs

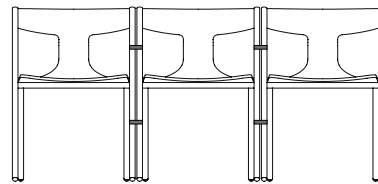

NOTE: Price per 2 units.

CODE	FINISHES	PUBLIC PRICE
QUAUN	black	25 DKK

Linking device for chairs with four legs base.
Black finish.



Copa

BY RAMOS & BASSOLS

CHAIRS AND STOOLS

Copa is the result of Viccarbe's tireless search for extraordinary comfort. Presenting a backrest with sinuous and particularly enveloping lines, this chair joins the collection with a wide range of bases.

The silhouette, inspired by the shapes of an elegant crystal glass, encapsulate the perfection of David Ramos and Jordi Bassols's idea of contemporary design.

Seat and backrest made of plywood covered with non-deformable expanded polyurethane of different densities.

CHAIR SEAT OPTIONS

Smooth upholstery

Wooden seat and plywood backrest with padding and smooth upholstery.

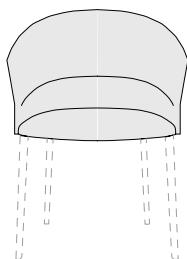

Soft upholstery

Wooden seat and plywood backrest with padding and soft upholstery.

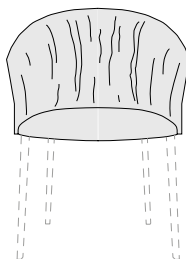

CHAIR BACKREST OPTIONS

Back in leather or ecoleather

Back part of the backrest upholstered in leather or ecoleather.

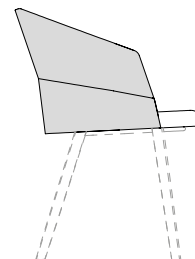

STOOL SEAT OPTIONS

Smooth upholstery

Wooden seat and plywood backrest with padding and smooth upholstery.

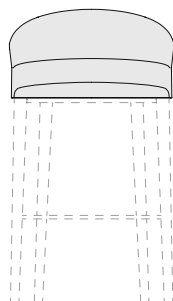

Soft upholstery

Wooden seat and plywood backrest with padding and soft upholstery.

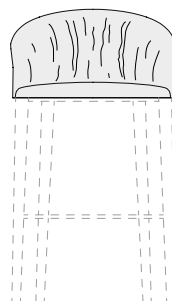

STOOL BACKREST OPTIONS

Back in leather or ecoleather

Back part of the backrest upholstered in leather or ecoleather.

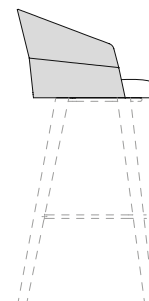

BASE OPTIONS

Four metal legs

Calibrated steel structure powder coated in thermoreinforced polyester in black or white. Black or white plastic glides with or without felt.



Four wooden legs

Four solid oak wood legs stained with the finishes of our collection. Black or white plastic glides with or without felt.

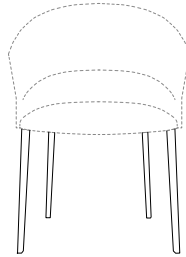

Four upholstered wooden legs

Four solid oak wood legs upholstered with leather or ecoleather. Black or white plastic glides with or without felt.

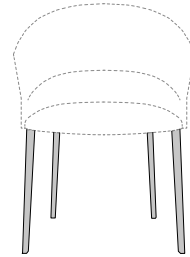

Cantilever

Calibrated steel structure powder coated in thermoreinforced polyester in black or white. Black or white plastic glides with or without felt.

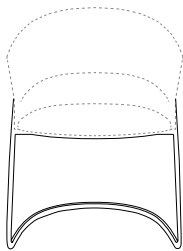

Pyramid swivel

Injected swivel aluminium base powder coated in thermoreinforced polyester in black or white microtexturized. Black or translucent plastic glides with or without felt.

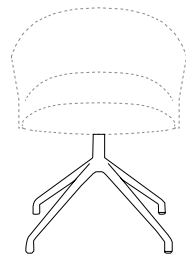

Pyramid swivel with casters

Injected swivel aluminium base powder coated in thermoreinforced polyester in black or white microtexturized with black or white soft casters for hard floors.

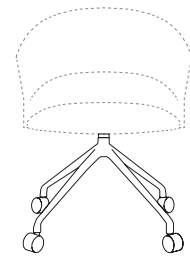

Five casters

Aluminum swivel base powder coated in black or white, height adjustment system and black or white soft casters for hard floors*.

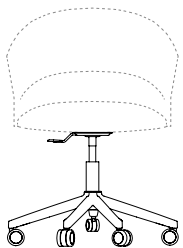

Flat swivel

Injected swivel aluminium base powder coated in thermoreinforced polyester in black or white microtexturized. Black or translucent plastic glides with or without felt.

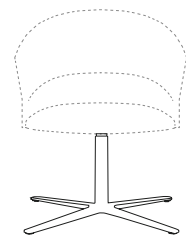

*6 weeks production time.

CHAIRS AND STOOLS

STOOL BASE OPTIONS

Fixed counter stool

Calibrated steel structure powder coated in thermoreinforced polyester in white or black. Footrest in the same colour. Black or white plastic glides with or without felt.

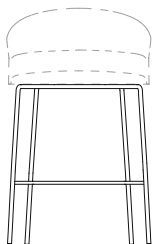

Fixed bar stool

Calibrated steel structure powder coated in thermoreinforced polyester in white or black. Footrest in the same colour. Black or white plastic glides with or without felt.

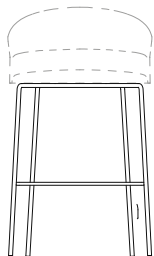

Swivel counter stool

Calibrated steel swivel structure powder coated in thermoreinforced polyester in white or black. Footrest in the same colour. Black or white plastic glides with or without felt.

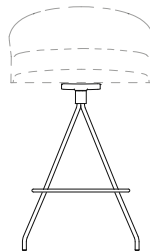

Swivel bar stool

Calibrated steel swivel structure powder coated in thermoreinforced polyester in white or black. Footrest in the same colour. Black or white plastic glides with or without felt.

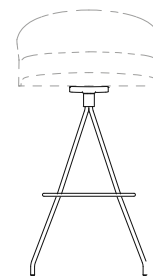

Four wooden legs counter stool

Four solid oak wood legs stained with the finishes of our collection. Footrest in calibrated steel powder coated in thermoreinforced polyester in black. Black or white plastic glides with or without felt.

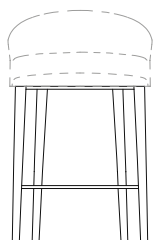

Four wooden legs bar stool

Four solid oak wood legs stained with the finishes of our collection. Footrest in calibrated steel powder coated in thermoreinforced polyester in black. Black or white plastic glides with or without felt.

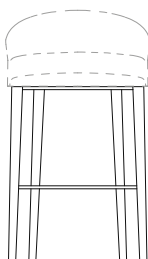

UPHOLSTERY OPTIONS AND FABRIC NEEDED

Calculated for fabric width 1.40m

Classic upholstery

Chair

Smooth upholstery: 2.1m
Soft upholstery: 2.1m

Stool

Smooth upholstery: 1.7m
Soft upholstery: 1.7m

Bicolor upholstery

Chair*

Seat: 1m
Backrest: 1.25m

Stool*

Seat: 0.85m
Backrest: 0.5m

Upholstery with leather/
eco-leather backrest

Chair*

Seat and backrest front: 1.60m
Backrest back: 0.70m

Stool*

Seat and backrest front: 1.20m
Backrest back: 0.60m

Bicolor upholstery with leather/
eco-leather backrest

Chair*

Seat: 1m
Backrest front: 0.65m
Backrest back: 0.70m

Stool*

Seat: 0.85m
Backrest front: 0.55m
Backrest back: 0.60m

*The measurings are valid for smooth and soft finish.

FOUR METAL LEGS BASE

Test certificates: ANSI BIFMA X5.4:2012 and UNE-EN 16139:2013vc2015

Calibrated steel structure powder coated in thermoreinforced polyester in black or white.

Black or white plastic glides with or without felt.*

The upholstery options available and the fabric needed for each option are indicated on **page 61**

Smooth upholstery

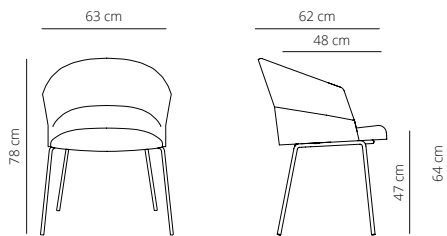

11.1 kg

(x1) 66x64x86 cm (0.35 m³)

CODE	FINISHES		PUBLIC PRICE
	STRUCTURE	UPHOLSTERY	
COME-1	black or white	G1 (T/C)	3.992 DKK
COME-2		G2	4.526 DKK
COME-3		G3	5.034 DKK
COME-4		G4	5.602 DKK
COME-5		G5	6.331 DKK

+ 58€
+ 117€



Is possible to upholster the back part of the backrest in ecoleather for an extra of 58€ or leather for 117€. In that case, it has to be noted in the invoice with the fabric's colour reference. If not indicated, it will be upholstered with the same fabric as the seat.

Soft upholstery

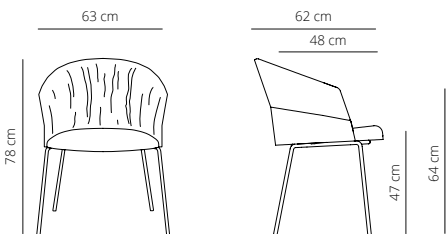

11.1 kg

(x1) 66x64x86 cm (0.35 m³)

CODE	FINISHES		PUBLIC PRICE
	STRUCTURE	UPHOLSTERY	
COMES-1	black or white	G1 (T/C)	4.856 DKK
COMES-2		G2	5.187 DKK
COMES-3		G3	5.924 DKK
COMES-4		G4	6.602 DKK
COMES-5		G5	7.280 DKK

+ 58€
+ 117€



Is possible to upholster the back part of the backrest in ecoleather for an extra of 58€ or leather for 117€. In that case, it has to be noted in the invoice with the fabric's colour reference. If not indicated, it will be upholstered with the same fabric as the seat.

+ 4€



*Felt glides available with an upcharge of 4€. If not indicated, the chair will be produced with plastic glides.

PYRAMID SWIVEL BASE

Test certificates: ANSI BIFMA X5.4:2012 and UNE-EN 16139:2013vc2015

Injected swivel aluminium base powder coated in thermoreinforced polyester in black or white microtexturized.

Black or translucent plastic glides, with or without felt*

The upholstery options available and the fabric needed for each option are indicated on **page 61**

Smooth upholstery

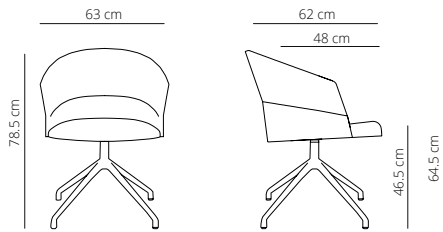

15.3 kg

(x1) 66x64x86 cm (0.36 m³)

CODE	FINISHES		PUBLIC PRICE
	STRUCTURE	UPHOLSTERY	
COPI-1	black or white (microtexturized)	G1 (T/C)	5.297 DKK
COPI-2		G2	5.763 DKK
COPI-3		G3	6.331 DKK
COPI-4		G4	6.899 DKK
COPI-5		G5	7.577 DKK

+ 58€
+ 117€



Is possible to upholster the back part of the backrest in ecoleather for an extra of 58€ or leather for 117€. In that case, it has to be noted in the invoice with the fabric's colour reference. If not indicated, it will be upholstered with the same fabric as the seat.

Soft upholstery

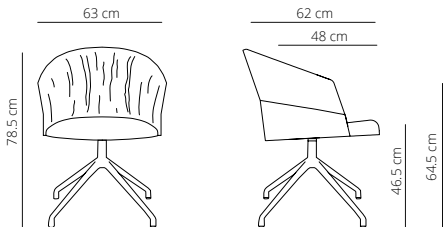

15.3 kg

(x1) 66x64x86 cm (0.36 m³)

CODE	FINISHES		PUBLIC PRICE
	STRUCTURE	UPHOLSTERY	
COPI-1	black or white (microtexturized)	G1 (T/C)	6.026 DKK
COPI-2		G2	6.331 DKK
COPI-3		G3	7.000 DKK
COPI-4		G4	7.653 DKK
COPI-5		G5	8.331 DKK

+ 58€
+ 117€



Is possible to upholster the back part of the backrest in ecoleather for an extra of 58€ or leather for 117€. In that case, it has to be noted in the invoice with the fabric's colour reference. If not indicated, it will be upholstered with the same fabric as the seat.

+ 4€



*Felt glides available with an upcharge of 4€. If not indicated, the chair will be produced with plastic glides.

PYRAMID SWIVEL WITH CASTERS BASE

Test certificates: ANSI BIFMA X5.4:2020 and UNE-EN 16139:2013vc2015

Injected swivel aluminium base powder coated in thermoreinforced polyester in black or white microtexturized with black or white soft casters for hard floors.

The upholstery options available and the fabric needed for each option are indicated on **page 61**

Smooth upholstery

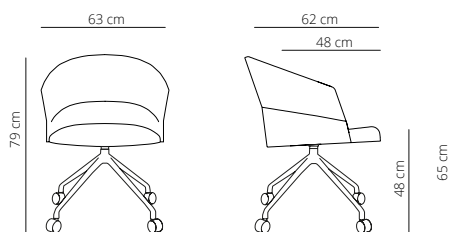

15.2 kg

(x1) 66x64x86 cm (0.36 m³)

CODE	FINISHES		PUBLIC PRICE
	STRUCTURE	UPHOLSTERY	
COPIRU-1	black or white (microtexturized)	G1 (T/C)	5.449 DKK
COPIRU-2		G2	5.924 DKK
COPIRU-3		G3	6.483 DKK
COPIRU-4		G4	7.060 DKK
COPIRU-5		G5	7.738 DKK

+ 58€
+ 117€



Is possible to upholster the back part of the backrest in ecoleather for an extra of 58€ or leather for 117€. In that case, it has to be noted in the invoice with the fabric's colour reference. If not indicated, it will be upholstered with the same fabric as the seat.

Soft upholstery

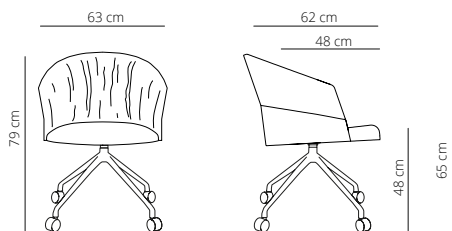

15.2 kg

(x1) 66x64x86 cm (0.36 m³)

CODE	FINISHES		PUBLIC PRICE
	STRUCTURE	UPHOLSTERY	
COPIRUS-1	black or white (microtexturized)	G1 (T/C)	6.170 DKK
COPIRUS-2		G2	6.509 DKK
COPIRUS-3		G3	7.127 DKK
COPIRUS-4		G4	7.772 DKK
COPIRUS-5		G5	8.500 DKK

+ 58€
+ 117€



Is possible to upholster the back part of the backrest in ecoleather for an extra of 58€ or leather for 117€. In that case, it has to be noted in the invoice with the fabric's colour reference. If not indicated, it will be upholstered with the same fabric as the seat.

FIVE CASTERS BASE

Test certificates: UNE-EN 16139:2013vc2015

Aluminum swivel base powder coated in black or white, height adjustment system and black or white soft casters for hard floors*.

*6 weeks production time.

NOTE: When the base is white, the gas lift tube is chrome finished

The upholstery options available and the fabric needed for each option are indicated on **page 61**

Smooth upholstery

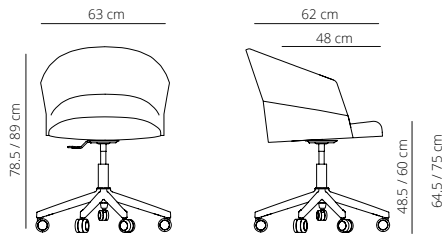

15.7 kg

(x1) 66x64x86 cm (0.36 m³)

CODE	FINISHES		PUBLIC PRICE
	STRUCTURE	UPHOLSTERY	
COBR-1	black or white (microtexturized)	G1 (T/C)	5.449 DKK
COBR-2		G2	5.924 DKK
COBR-3		G3	6.483 DKK
COBR-4		G4	7.060 DKK
COBR-5		G5	7.738 DKK

+ 58€
+ 117€



Is possible to upholster the back part of the backrest in ecoleather for an extra of 58€ or leather for 117€. In that case, it has to be noted in the invoice with the fabric's colour reference. If not indicated, it will be upholstered with the same fabric as the seat.

Soft upholstery

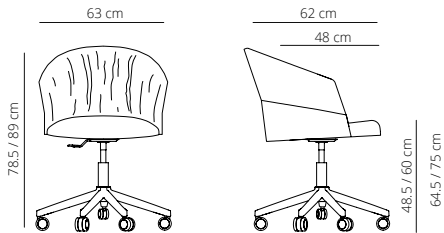

15.7 kg

(x1) 66x64x86 cm (0.36 m³)

CODE	FINISHES		PUBLIC PRICE
	STRUCTURE	UPHOLSTERY	
COBRS-1	black or white (microtexturized)	G1 (T/C)	6.170 DKK
COBRS-2		G2	6.509 DKK
COBRS-3		G3	7.127 DKK
COBRS-4		G4	7.772 DKK
COBRS-5		G5	8.500 DKK

+ 58€
+ 117€



Is possible to upholster the back part of the backrest in ecoleather for an extra of 58€ or leather for 117€. In that case, it has to be noted in the invoice with the fabric's colour reference. If not indicated, it will be upholstered with the same fabric as the seat.

CANTILEVER BASE

Test certificates: ANSI BIFMA X5.4:2020 and UNE-EN 16139:2013vc2015
 Calibrated steel structure powder coated in thermoreinforced polyester in black or white.
 Black or white plastic glides or black without felt or transparent plastic glides with felt.*

The upholstery options available and the fabric needed for each option are indicated on **page 61**

Smooth upholstery

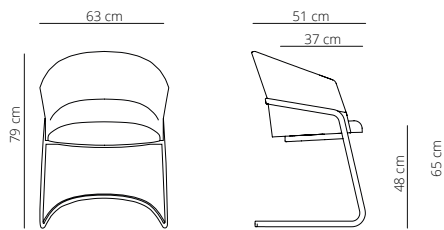

17.7 kg
 (x1) 66x64x86 cm (0.36 m³)

CODE	FINISHES		PUBLIC PRICE
	STRUCTURE	UPHOLSTERY	
COCL-1	black or white	G1 (T/C)	5.602 DKK
COCL-2		G2	6.068 DKK
COCL-3		G3	6.644 DKK
COCL-4		G4	7.212 DKK
COCL-5		G5	7.890 DKK

+ 58€
 + 117€



Is possible to upholster the back part of the backrest in ecoleather for an extra of 58€ or leather for 117€. In that case, it has to be noted in the invoice with the fabric's colour reference. If not indicated, it will be upholstered with the same fabric as the seat.

Soft upholstery

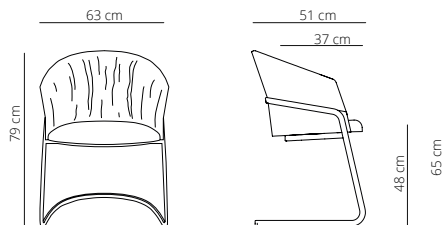

17.7 kg
 (x1) 66x64x86 cm (0.36 m³)

CODE	FINISHES		PUBLIC PRICE
	STRUCTURE	UPHOLSTERY	
COCLS-1	black or white	G1 (T/C)	6.305 DKK
COCLS-2		G2	6.670 DKK
COCLS-3		G3	7.356 DKK
COCLS-4		G4	8.017 DKK
COCLS-5		G5	8.678 DKK

+ 58€
 + 117€



Is possible to upholster the back part of the backrest in ecoleather for an extra of 58€ or leather for 117€. In that case, it has to be noted in the invoice with the fabric's colour reference. If not indicated, it will be upholstered with the same fabric as the seat.

+ 4€



*Felt glides available with an upcharge of 4€. If not indicated, the chair will be produced with plastic glides.

FLAT SWIVEL BASE

Injected swivel aluminium base powder coated in thermoreinforced polyester in black or white microtexturized. Black or translucent plastic glides, with or without felt.*

The upholstery options available and the fabric needed for each option are indicated on **page 61**

Smooth upholstery

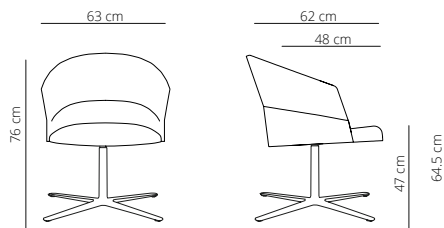

15.2 kg
(x1) 66x64x86 cm (0.36 m³)

CODE	FINISHES		PUBLIC PRICE
	STRUCTURE	UPHOLSTERY	
COPLA-1	black or white (microtexturized)	G1 (T/C)	5.602 DKK
COPLA-2		G2	6.068 DKK
COPLA-3		G3	6.644 DKK
COPLA-4		G4	7.212 DKK
COPLA-5		G5	7.890 DKK

+ 58€
+ 117€



Is possible to upholster the back part of the backrest in ecoleather for an extra of 58€ or leather for 117€. In that case, it has to be noted in the invoice with the fabric's colour reference. If not indicated, it will be upholstered with the same fabric as the seat.

Soft upholstery

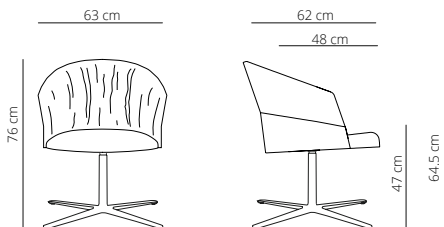

15.2 kg
(x1) 66x64x86 cm (0.36 m³)

CODE	FINISHES		PUBLIC PRICE
	STRUCTURE	UPHOLSTERY	
COPLAS-1	black or white (microtexturized)	G1 (T/C)	6.305 DKK
COPLAS-2		G2	6.670 DKK
COPLAS-3		G3	7.356 DKK
COPLAS-4		G4	8.017 DKK
COPLAS-5		G5	8.678 DKK

+ 58€
+ 117€



Is possible to upholster the back part of the backrest in ecoleather for an extra of 58€ or leather for 117€. In that case, it has to be noted in the invoice with the fabric's colour reference. If not indicated, it will be upholstered with the same fabric as the seat.

+ 4€



*Felt glides available with an upcharge of 4€. If not indicated, the chair will be produced with plastic glides.

FOUR WOODEN LEGS BASE

Test certificates: ANSI BIFMA X5.4:2012 and UNE-EN 16139:2013vc2015

Four solid oak wood legs stained with the finishes of our collection.
Black or white plastic glides with or without felt*

The upholstery options available and the fabric needed for each option are indicated on **page 61**

Smooth upholstery

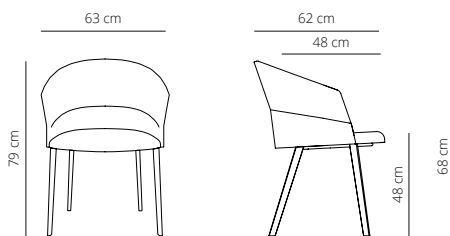

11.2 kg

(x1) 66x64x86 cm (0.36 m³)

CODE	FINISHES		PUBLIC PRICE
	STRUCTURE	UPHOLSTERY	
COMA-1	matt oak, cognac, ash, bleached oak or walnut	G1 (T/C)	5.602 DKK
COMA-2		G2	6.068 DKK
COMA-3		G3	6.644 DKK
COMA-4		G4	7.212 DKK
COMA-5		G5	7.890 DKK

+ 58€
+ 117€



Is possible to upholster the back part of the backrest in ecoleather for an extra of 58€ or leather for 117€. In that case, it has to be noted in the invoice with the fabric's colour reference. If not indicated, it will be upholstered with the same fabric as the seat.

Soft upholstery

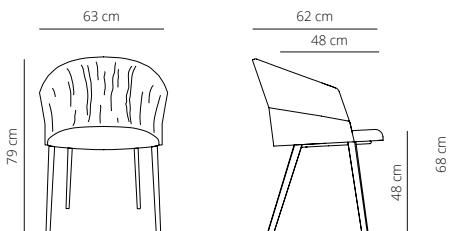

11.2 kg

(x1) 66x64x86 cm (0.36 m³)

CODE	FINISHES		PUBLIC PRICE
	STRUCTURE	UPHOLSTERY	
COMAS-1	matt oak, cognac, ash, bleached oak or walnut	G1 (T/C)	6.305 DKK
COMAS-2		G2	6.670 DKK
COMAS-3		G3	7.356 DKK
COMAS-4		G4	8.017 DKK
COMAS-5		G5	8.678 DKK

+ 58€
+ 117€



Is possible to upholster the back part of the backrest in ecoleather for an extra of 58€ or leather for 117€. In that case, it has to be noted in the invoice with the fabric's colour reference. If not indicated, it will be upholstered with the same fabric as the seat.

+ 4€



*Felt glides available with an upcharge of 4€. If not indicated, the chair will be produced with plastic glides.

FOUR UPHOLSTERED WOODEN LEGS BASE

Test certificates: ANSI BIFMA X5.4:2012 and UNE-EN 16139:2013vc2015

Four solid oak wood legs upholstered with leather or ecoleather.

Black or white plastic glides with or without felt*

The upholstery options available and the fabric needed for each option are indicated on **page 61**

Smooth upholstery

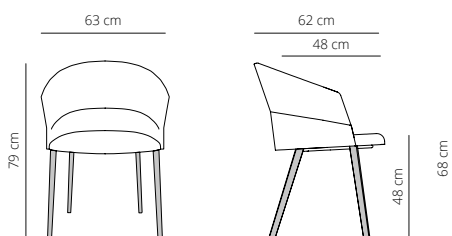

11.2 kg

(x1) 66x64x86 cm (0.36 m³)

CODE	FINISHES		PUBLIC PRICE
	STRUCTURE	UPHOLSTERY	
COPTP-1	ecoleather	G1 (T/C)	6.899 DKK
COPTP-2		G2	7.373 DKK
COPTP-3		G3	7.933 DKK
COPTP-4		G4	8.509 DKK
COPTP-5		G5	9.178 DKK
COPTL-1	leather	G1 (T/C)	7.424 DKK
COPTL-2		G2	7.890 DKK
COPTL-3		G3	8.458 DKK
COPTL-4		G4	9.034 DKK
COPTL-5		G5	9.712 DKK

+ 58€
+ 117€



Is possible to upholster the back part of the backrest in ecoleather for an extra of 58€ or leather for 117€. In that case, it has to be noted in the invoice with the fabric's colour reference. If not indicated, it will be upholstered with the same fabric as the seat.

Soft upholstery

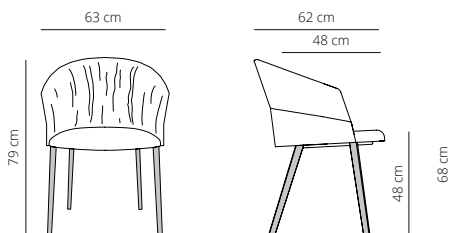

11.2 kg

(x1) 66x64x86 cm (0.36 m³)

CODE	FINISHES		PUBLIC PRICE
	STRUCTURE	UPHOLSTERY	
COPTPS-1	ecoleather	G1 (T/C)	7.526 DKK
COPTPS-2		G2	8.034 DKK
COPTPS-3		G3	8.661 DKK
COPTPS-4		G4	9.272 DKK
COPTPS-5		G5	10.017 DKK
COPTLS-1	leather	G1 (T/C)	8.085 DKK
COPTLS-2		G2	8.602 DKK
COPTLS-3		G3	9.229 DKK
COPTLS-4		G4	9.848 DKK
COPTLS-5		G5	10.577 DKK

+ 58€
+ 117€



Is possible to upholster the back part of the backrest in ecoleather for an extra of 58€ or leather for 117€. In that case, it has to be noted in the invoice with the fabric's colour reference. If not indicated, it will be upholstered with the same fabric as the seat.

+ 4€



*Felt glides available with an upcharge of 4€. If not indicated, the chair will be produced with plastic glides.

FIXED COUNTER STOOL BASE

Test certificates: ANSI BIFMA X5.4:2020 and UNE-EN 16139:2013vc2015

Calibrated steel structure powder coated in thermoreinforced polyester in white or black. Footrest in the same colour. Black or white plastic glides with or without felt.*

The upholstery options available and the fabric needed for each option are indicated on **page 61**

Smooth upholstery

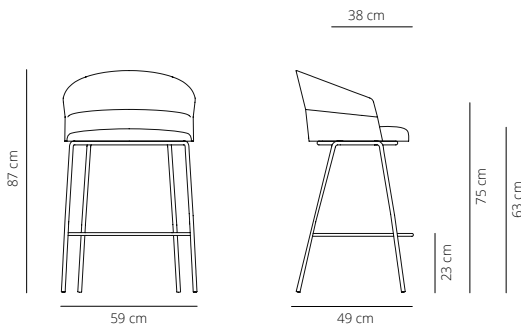

8.8 kg

(x1) 100x62x51 cm (0.32 m³)

CODE	FINISHES		PUBLIC PRICE
	STRUCTURE	UPHOLSTERY	
COT4MECO-1	black or white	G1 (T/C)	4.415 DKK
COT4MECO-2		G2	4.721 DKK
COT4MECO-3		G3	5.238 DKK
COT4MECO-4		G4	5.763 DKK
COT4MECO-5		G5	6.331 DKK

+ 58€
+ 117€



Is possible to upholster the back part of the backrest in ecoleather for an extra of 58€ or leather for 117€. In that case, it has to be noted in the invoice with the fabric's colour reference. If not indicated, it will be upholstered with the same fabric as the seat.

Soft upholstery

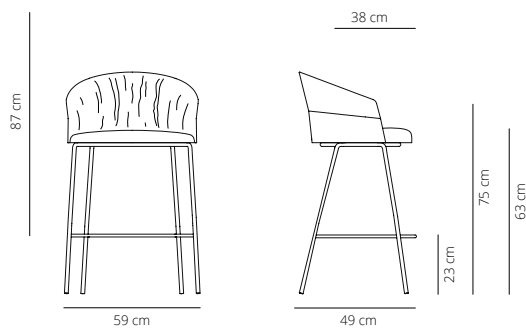

8.8 kg

(x1) 100x62x51 cm (0.32 m³)

CODE	FINISHES		PUBLIC PRICE
	STRUCTURE	UPHOLSTERY	
COT4MECOS-1	black or white	G1 (T/C)	5.077 DKK
COT4MECOS-2		G2	5.424 DKK
COT4MECOS-3		G3	6.043 DKK
COT4MECOS-4		G4	6.644 DKK
COT4MECOS-5		G5	7.280 DKK

+ 58€
+ 117€



Is possible to upholster the back part of the backrest in ecoleather for an extra of 58€ or leather for 117€. In that case, it has to be noted in the invoice with the fabric's colour reference. If not indicated, it will be upholstered with the same fabric as the seat.

+ 4€



*Felt glides available with an upcharge of 4€. If not indicated, the chair will be produced with plastic glides.

FIXED BAR STOOL BASE

Test certificates: ANSI BIFMA X5.4:2020 and UNE-EN 16139:2013vc2015

Calibrated steel structure powder coated in thermoreinforced polyester in white or black. Footrest in the same colour. Black or white plastic glides with or without felt.*

The upholstery options available and the fabric needed for each option are indicated on **page 61**

Smooth upholstery

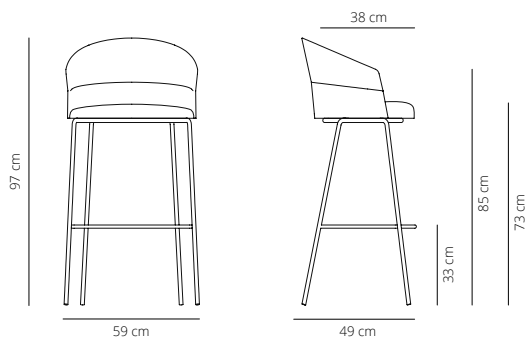

9.2 kg

(x1) 106x62x51 cm (0.33 m³)

CODE	FINISHES		PUBLIC PRICE
	STRUCTURE	UPHOLSTERY	
COT4MEBAR-1	black or white	G1 (T/C)	4.415 DKK
COT4MEBAR-2		G2	4.721 DKK
COT4MEBAR-3		G3	5.238 DKK
COT4MEBAR-4		G4	5.763 DKK
COT4MEBAR-5		G5	6.331 DKK

+ 58€
+ 117€



Is possible to upholster the back part of the backrest in ecoleather for an extra of 58€ or leather for 117€. In that case, it has to be noted in the invoice with the fabric's colour reference. If not indicated, it will be upholstered with the same fabric as the seat.

Soft upholstery

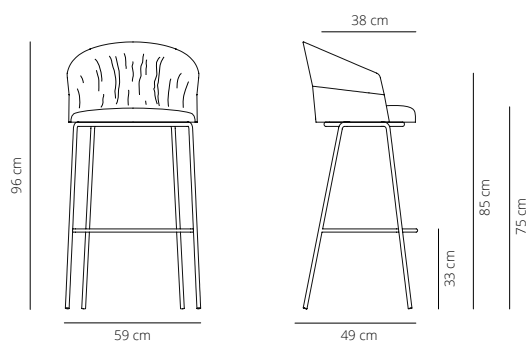

9.2 kg

(x1) 106x62x51 cm (0.33 m³)

CODE	FINISHES		PUBLIC PRICE
	STRUCTURE	UPHOLSTERY	
COT4MEBARS-1	black or white	G1 (T/C)	5.077 DKK
COT4MEBARS-2		G2	5.424 DKK
COT4MEBARS-3		G3	6.043 DKK
COT4MEBARS-4		G4	6.644 DKK
COT4MEBARS-5		G5	7.280 DKK

+ 58€
+ 117€



Is possible to upholster the back part of the backrest in ecoleather for an extra of 58€ or leather for 117€. In that case, it has to be noted in the invoice with the fabric's colour reference. If not indicated, it will be upholstered with the same fabric as the seat.

+ 4€



*Felt glides available with an upcharge of 4€. If not indicated, the chair will be produced with plastic glides.

SWIVEL COUNTER STOOL BASE

Test certificates: ANSI BIFMA X5.4:2020 and UNE-EN 16139:2013vc2015

Calibrated steel swivel structure powder coated in thermoreinforced polyester in white or black. Footrest in the same colour. Black or white plastic glides with or without felt.*

The upholstery options available and the fabric needed for each option are indicated on **page 61**

Smooth upholstery

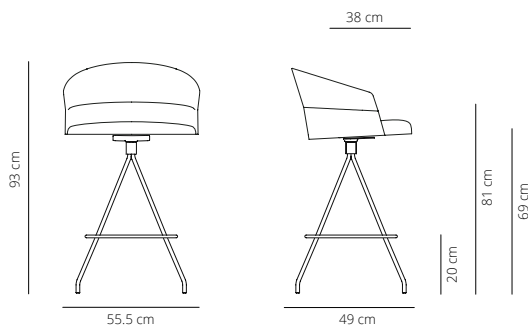

9.8 kg

(x1) 100x62x57 cm (0.35 m³)

CODE	FINISHES		PUBLIC PRICE
	STRUCTURE	UPHOLSTERY	
COTGCO-1	black or white	G1 (T/C)	5.399 DKK
COTGCO-2		G2	5.763 DKK
COTGCO-3		G3	6.331 DKK
COTGCO-4		G4	6.797 DKK
COTGCO-5		G5	7.314 DKK

+ 58€
+ 117€



Is possible to upholster the back part of the backrest in ecoleather for an extra of 58€ or leather for 117€. In that case, it has to be noted in the invoice with the fabric's colour reference. If not indicated, it will be upholstered with the same fabric as the seat.

Soft upholstery

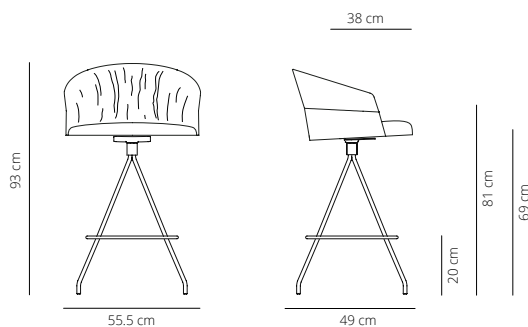

9.8 kg

(x1) 100x62x57 cm (0.35 m³)

CODE	FINISHES		PUBLIC PRICE
	STRUCTURE	UPHOLSTERY	
COTGCOS-1	black or white	G1 (T/C)	6.271 DKK
COTGCOS-2		G2	6.627 DKK
COTGCOS-3		G3	7.238 DKK
COTGCOS-4		G4	7.797 DKK
COTGCOS-5		G5	8.399 DKK

+ 58€
+ 117€



Is possible to upholster the back part of the backrest in ecoleather for an extra of 58€ or leather for 117€. In that case, it has to be noted in the invoice with the fabric's colour reference. If not indicated, it will be upholstered with the same fabric as the seat.

+ 4€



*Felt glides available with an upcharge of 4€. If not indicated, the chair will be produced with plastic glides.

SWIVEL BAR STOOL BASE

Test certificates: ANSI BIFMA X5.4:2020 and UNE-EN 16139:2013vc2015

Calibrated steel swivel structure powder coated in thermoreinforced polyester in white or black. Footrest in the same colour. Black or white plastic glides with or without felt.*

The upholstery options available and the fabric needed for each option are indicated on **page 61**

Smooth upholstery

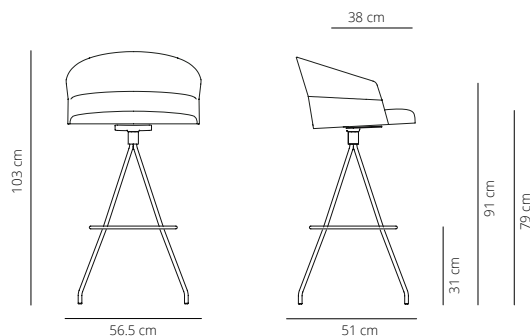

10.2 kg

(x1) 106x62x57 cm (0.37 m³)

Soft upholstery

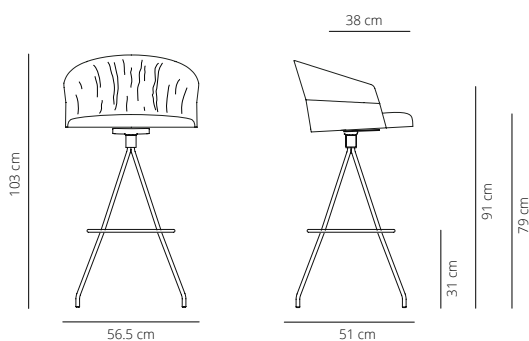

10.2 kg

(x1) 106x62x57 cm (0.37 m³)

CODE	FINISHES		PUBLIC PRICE
	STRUCTURE	UPHOLSTERY	
COTGBAR-1	black or white	G1 (T/C)	5.399 DKK
COTGBAR-2		G2	5.763 DKK
COTGBAR-3		G3	6.331 DKK
COTGBAR-4		G4	6.797 DKK
COTGBAR-5		G5	7.314 DKK

+ 58€
+ 117€



Is possible to upholster the back part of the backrest in ecoleather for an extra of 58€ or leather for 117€. In that case, it has to be noted in the invoice with the fabric's colour reference. If not indicated, it will be upholstered with the same fabric as the seat.

CODE	FINISHES		PUBLIC PRICE
	STRUCTURE	UPHOLSTERY	
COTGBARS-1	black or white	G1 (T/C)	6.271 DKK
COTGBARS-2		G2	6.627 DKK
COTGBARS-3		G3	7.238 DKK
COTGBARS-4		G4	7.797 DKK
COTGBARS-5		G5	8.399 DKK

+ 58€
+ 117€



Is possible to upholster the back part of the backrest in ecoleather for an extra of 58€ or leather for 117€. In that case, it has to be noted in the invoice with the fabric's colour reference. If not indicated, it will be upholstered with the same fabric as the seat.

+ 4€



*Felt glides available with an upcharge of 4€. If not indicated, the chair will be produced with plastic glides.

FOUR WOODEN LEGS COUNTER STOOL BASE

Test certificates: ANSI BIFMA X5.4:2020 and UNE-EN 16139:2013vc2015

Four solid oak wood legs stained with the finishes of our collection. Footrest in calibrated steel powder coated in thermoreinforced polyester in black. Black or white plastic glides with or without felt.*

The upholstery options available and the fabric needed for each option are indicated on **page 61**

Smooth upholstery

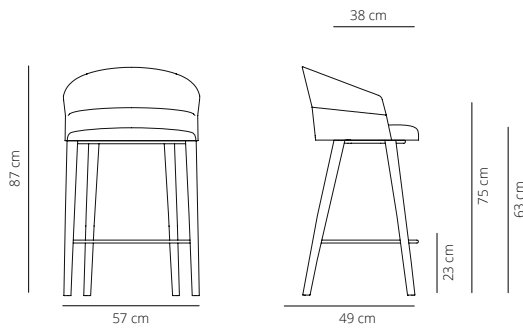

9.7 kg

(x1) 100x62x57 cm (0.35 m³)

CODE	FINISHES		PUBLIC PRICE
	STRUCTURE	UPHOLSTERY	
COT4MACO-1	matt oak, cognac, ash, bleached oak or walnut	G1 (T/C)	6.390 DKK
COT4MACO-2		G2	6.644 DKK
COT4MACO-3		G3	7.111 DKK
COT4MACO-4		G4	7.636 DKK
COT4MACO-5		G5	8.204 DKK

+ 58€
+ 117€



Is possible to upholster the back part of the backrest in ecoleather for an extra of 58€ or leather for 117€. In that case, it has to be noted in the invoice with the fabric's colour reference. If not indicated, it will be upholstered with the same fabric as the seat.

Soft upholstery

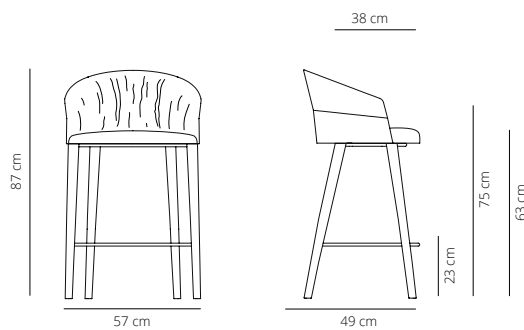

9.7 kg

(x1) 100x62x57 cm (0.35 m³)

CODE	FINISHES		PUBLIC PRICE
	STRUCTURE	UPHOLSTERY	
COT4MACOS-1	matt oak, cognac, ash, bleached oak or walnut	G1 (T/C)	7.365 DKK
COT4MACOS-2		G2	7.644 DKK
COT4MACOS-3		G3	8.246 DKK
COT4MACOS-4		G4	8.856 DKK
COT4MACOS-5		G5	9.416 DKK

+ 58€
+ 117€



Is possible to upholster the back part of the backrest in ecoleather for an extra of 58€ or leather for 117€. In that case, it has to be noted in the invoice with the fabric's colour reference. If not indicated, it will be upholstered with the same fabric as the seat.

+ 4€



*Felt glides available with an upcharge of 4€. If not indicated, the chair will be produced with plastic glides.

FOUR WOODEN LEGS BAR STOOL BASE

Test certificates: ANSI BIFMA X5.4:2020 and UNE-EN 16139:2013vc2015

Four solid oak wood legs stained with the finishes of our collection. Footrest in calibrated steel powder coated in thermoreinforced polyester in black. Black or white plastic glides with or without felt.*

The upholstery options available and the fabric needed for each option are indicated on **page 61**

Smooth upholstery

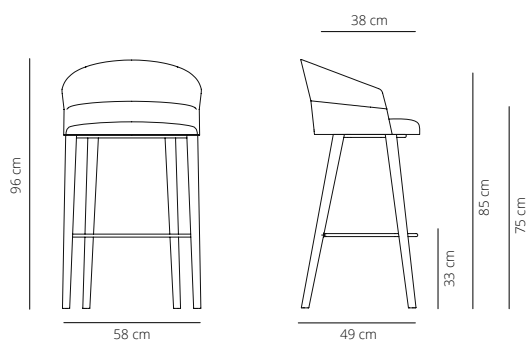

📦 10.1 kg

📦 (x1) 106x62x57 cm (0.37 m³)

CODE	FINISHES		PUBLIC PRICE
	STRUCTURE	UPHOLSTERY	
COT4MABAR-1	matt oak, cognac, ash, bleached oak or walnut	G1 (T/C)	6.390 DKK
COT4MABAR-2		G2	6.644 DKK
COT4MABAR-3		G3	7.111 DKK
COT4MABAR-4		G4	7.636 DKK
COT4MABAR-5		G5	8.204 DKK

+ 58€
+ 117€



Is possible to upholster the back part of the backrest in ecoleather for an extra of 58€ or leather for 117€. In that case, it has to be noted in the invoice with the fabric's colour reference. If not indicated, it will be upholstered with the same fabric as the seat.

Soft upholstery

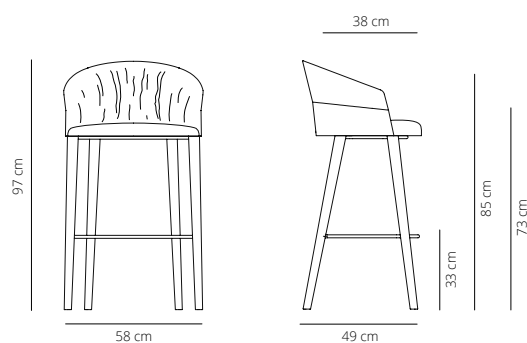

📦 10.1 kg

📦 (x1) 106x62x57 cm (0.37 m³)

CODE	FINISHES		PUBLIC PRICE
	STRUCTURE	UPHOLSTERY	
COT4MABARS-1	matt oak, cognac, ash, bleached oak or walnut	G1 (T/C)	7.365 DKK
COT4MABARS-2		G2	7.644 DKK
COT4MABARS-3		G3	8.246 DKK
COT4MABARS-4		G4	8.856 DKK
COT4MABARS-5		G5	9.416 DKK

+ 58€
+ 117€



Is possible to upholster the back part of the backrest in ecoleather for an extra of 58€ or leather for 117€. In that case, it has to be noted in the invoice with the fabric's colour reference. If not indicated, it will be upholstered with the same fabric as the seat.

+ 4€



*Felt glides available with an upcharge of 4€. If not indicated, the chair will be produced with plastic glides.



Aleta

BY JAIME HAYON

CHAIRS AND STOOLS

Inspired by the physiognomy and movement of sharks, Jaime Hayon has created the Aleta collection for Viccarbe.

The collection is designed and created for use in public spaces like restaurants, hotels or offices as well as residential spaces.

For the production of this pieces Viccarbe is using wood from certified sustainable forestry sources.

NOTE: This collection offers the possibility of two-colour upholstery, with one colour for the seat and another for the back. In this case, always calculate based on the price of the fabric in the higher category.

SEAT OPTIONS

High backrest

Moulded plywood seat and backrest covered with expanded non-deformable polyurethane foam.

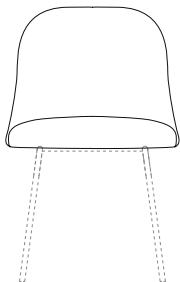

High backrest with armrest

Moulded plywood seat and backrest covered with expanded non-deformable polyurethane foam.

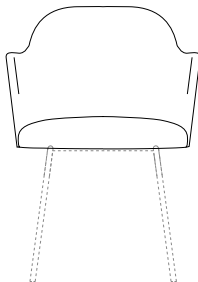

SEAT OPTIONS

Low backrest

Moulded plywood seat and backrest covered with expanded polyurethane foam.

* Only available for stools.

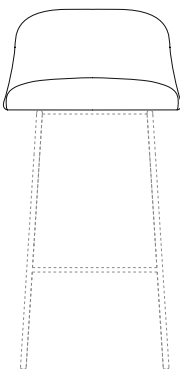

High backrest

Moulded plywood seat and backrest covered with expanded non-deformable polyurethane foam.

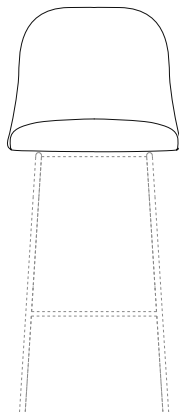

High backrest with armrest

Moulded plywood seat and backrest covered with expanded non-deformable polyurethane foam.

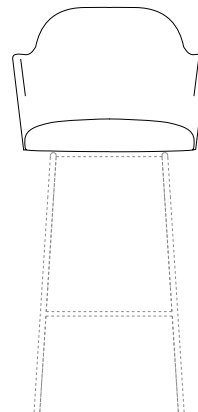

CHAIR BASE OPTIONS

Four metal legs

Calibrated steel structure with brass finish or powder coated in thermoreinforced polyester in white, black or taupe. Black or white glides with or without felt.

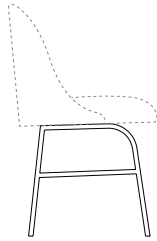

Swivel

Calibrated steel swivel structure powder coated in thermoreinforced polyester in white, black or taupe. Black or white glides with or without felt.

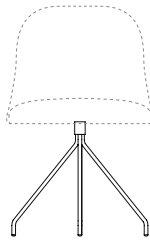

Pyramid swivel

Injected swivel aluminium base powder coated in thermoreinforced polyester in black or white microtexturized. Black or translucent glides with or without felt.

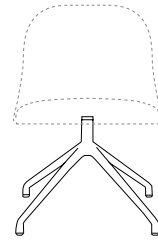

Pyramid swivel with casters

Injected swivel aluminium base powder coated in thermoreinforced polyester in black or white microtexturized with black or white soft casters for hard floors.

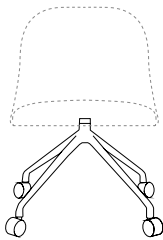

Five casters

Aluminum swivel base powder coated in black or white (high gloss), height adjustment system and black or white soft casters for hard floors.*

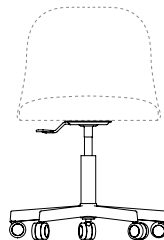

**6 weeks production time*

Flat swivel

Injected swivel aluminium base powder coated in thermoreinforced polyester in black or white microtexturized. Black or translucent plastic glides with or without felt.

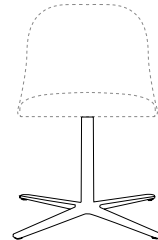

Four wooden legs

Structure in solid oak wood stained with the finishes of our collection. Black or white plastic glides with or without felt.

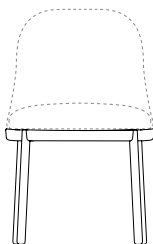

STOOL BASE OPTIONS

Fixed counter stool

Calibrated steel structure with brass finish or powder coated in thermoreinforced polyester in white, black or taupe. Black or white plastic glides with or without felt.

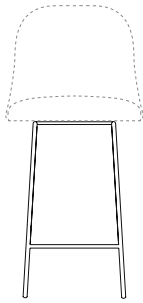

Fixed bar stool

Calibrated steel structure with brass finish or powder coated in thermoreinforced polyester in white, black or taupe. Black or white plastic glides with or without felt.

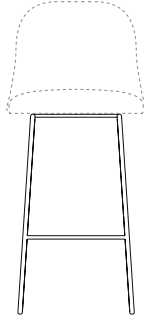

Swivel counter stool

Calibrated steel swivel structure powder coated in thermoreinforced polyester in white, black or taupe. Black or white plastic glides with or without felt.

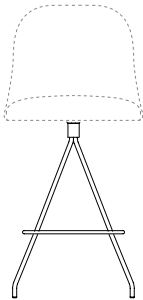

Swivel bar stool

Calibrated steel swivel structure powder coated in thermoreinforced polyester in white, black or taupe. Black or white plastic glides with or without felt.

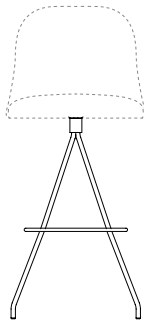

Aleta

2017, BY JAIME HAYON

CHAIRS AND STOOLS

Test certificates: ANSI BIFMA X5.4:2012 and UNE-EN 16139:2013vc2015

- 1- Calibrated steel structure with brass finish or powder coated in thermoreinforced polyester in white, black or taupe.
- 2- Moulded plywood seat and backrest covered with expanded polyuretane foam.
- 3- Fabric or leather.
- 4- Black or white glides with or without felt.*

NOTE: This collection offers the possibility of two-color upholstery, with one color for the seat and another for the back. In this case, always calculate based on the price of the fabric in the higher category.



Needed fabric for material: 1.40 m wide:

Chair:

1 Colour: total 1.4 m

2 Colours: seat 0.9 m / backrest 1.3 m

Chair with armrest:

1 Colour: total 1.5 m

2 Colours: seat 0.9 m / backrest 1.3 m

FOUR METAL LEGS BASE

Chair

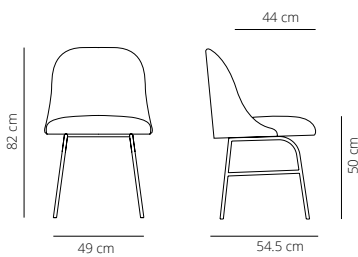

12.8 kg
(x1) 59x53x89 cm (0.28 m³)

CODE	FINISHES		PUBLIC PRICE
	STRUCTURE	UPHOLSTERY	
ALSIME-1	black, white or taupe	G1 (COM/COL)	4.204 DKK
ALSIME-2		G2	4.721 DKK
ALSIME-3		G3	5.297 DKK
ALSIME-4		G4	5.924 DKK
ALSIME-5		G5	6.644 DKK
ALSIME-1	brass finish	G1 (COM/COL)	7.212 DKK
ALSIME-2		G2	7.678 DKK
ALSIME-3		G3	8.305 DKK
ALSIME-4		G4	8.924 DKK
ALSIME-5		G5	9.602 DKK

Chair with armrest

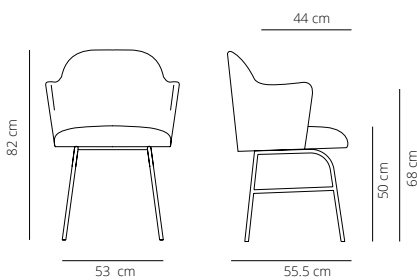

13.9 kg
(x1) 59x53x89 cm (0.28 m³)

CODE	FINISHES		PUBLIC PRICE
	STRUCTURE	UPHOLSTERY	
ALSIMEBR-1	black, white or taupe	G1 (COM/COL)	5.085 DKK
ALSIMEBR-2		G2	5.653 DKK
ALSIMEBR-3		G3	6.433 DKK
ALSIMEBR-4		G4	7.170 DKK
ALSIMEBR-5		G5	8.043 DKK
ALSIMEBR-1	brass finish	G1 (COM/COL)	8.102 DKK
ALSIMEBR-2		G2	8.670 DKK
ALSIMEBR-3		G3	9.390 DKK
ALSIMEBR-4		G4	10.170 DKK
ALSIMEBR-5		G5	11.001 DKK

+ 4€

*Felt glides available with an upcharge of 4€. If not indicated, the chair will be produced with plastic glides.

CHAIRS AND STOOLS

- 1- Calibrated steel swivel structure powder coated in thermoreinforced polyester in white, black or taupe
- 2-Moulded plywood seat and backrest covered with expanded polyuretane foam.
- 3- Fabric or leather.
- 4- Black or white plastic glides with or without felt.*

NOTE: This collection offers the possibility of two-color upholstery, with one color for the seat and another for the back. In this case, always calculate based on the price of the fabric in the higher category.



Needed fabric for material: 1.40 m wide:

- Chair:**
- 1 Colour: total 1.4 m
- 2 Colours: seat 0.9 m / backrest 1.3 m
- Chair with armrest:**
- 1 Colour: total 1.5 m
- 2 Colours: seat 0.9 m / backrest 1.3 m

SWIVEL BASE

Chair

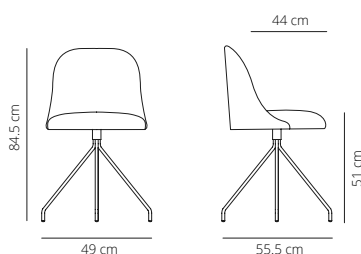

14.3 kg
 (x1) 59x53x89 cm (0.28 m³)

CODE	FINISHES		PUBLIC PRICE
	STRUCTURE	UPHOLSTERY	
ALSIG-1	black, white or taupe	G1 (COM/COL)	5.297 DKK
ALSIG-2		G2	5.763 DKK
ALSIG-3		G3	6.390 DKK
ALSIG-4		G4	7.009 DKK
ALSIG-5		G5	7.678 DKK

Chair with armrest

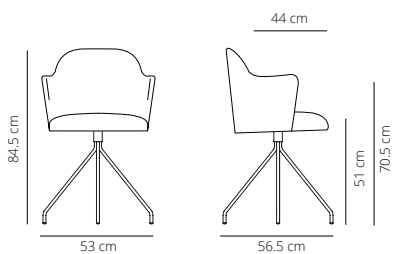

15.4 kg
 (x1) 59x53x89 cm (0.28 m³)

CODE	FINISHES		PUBLIC PRICE
	STRUCTURE	UPHOLSTERY	
ALSIGBR-1	black, white or taupe	G1 (COM/COL)	6.136 DKK
ALSIGBR-2		G2	6.755 DKK
ALSIGBR-3		G3	7.466 DKK
ALSIGBR-4		G4	8.255 DKK
ALSIGBR-5		G5	9.085 DKK



+ 4€ *Felt glides available with an upcharge of 4€. If not indicated, the chair will be produced with plastic glides.

Aleta

2017, BY JAIME HAYON

CHAIRS AND STOOLS

Test certificates: ANSI BIFMA X5.4:2012 and UNE-EN 16139:2013vc2015 (without armrest)

- 1- Injected swivel aluminium base powder coated in thermoreinforced polyester in black or white microtexturized.
- 2-Moulded plywood seat and backrest covered with expanded polyuretane foam.
- 3- Fabric or leather.
- 4- Black or translucent glides with or without felt.*

NOTE: This collection offers the possibility of two-color upholstery, with one color for the seat and another for the back. In this case, always calculate based on the price of the fabric in the higher category.



Needed fabric for material: 1.40 m wide:

Chair:

1 Colour: total 1.4 m
2 Colours: seat 0.9 m / backrest 1.3 m

Chair with armrest:

1 Colour: total 1.5 m
2 Colours: seat 0.9 m / backrest 1.3 m

PYRAMID SWIVEL BASE

Chair

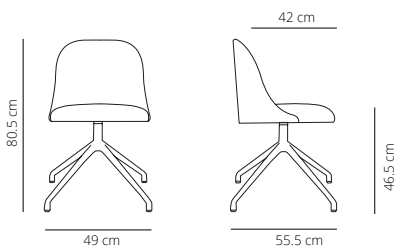

- 👤 13.3 kg
- 📦 (x1) 58x54x88 cm (0.28 m³)

CODE	FINISHES		PUBLIC PRICE
	STRUCTURE	UPHOLSTERY	
ALSIPI-1	black or white (microtexturized)	G1 (COM/COL)	5.509 DKK
ALSIPI-2		G2	5.966 DKK
ALSIPI-3		G3	6.594 DKK
ALSIPI-4		G4	7.212 DKK
ALSIPI-5		G5	7.890 DKK

Chair with armrest

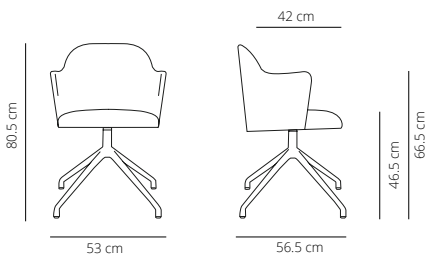

- 👤 14.4 kg
- 📦 (x1) 58x54x88 cm (0.28 m³)

CODE	FINISHES		PUBLIC PRICE
	STRUCTURE	UPHOLSTERY	
ALSIPIBR-1	black or white (microtexturized)	G1 (COM/COL)	6.390 DKK
ALSIPIBR-2		G2	6.958 DKK
ALSIPIBR-3		G3	7.678 DKK
ALSIPIBR-4		G4	8.458 DKK
ALSIPIBR-5		G5	9.289 DKK

+ 4€

*Felt glides available with an upcharge of 4€. If not indicated, the chair will be produced with plastic glides.

CHAIRS AND STOOLS

Test certificates: ANSI BIFMA X5.4:2012 and UNE-EN 16139:2013vc2015 (without armrest)

- 1- Injected swivel aluminium base powder coated in thermoreinforced polyester in black or white microtexturized.
- 2- Moulded plywood seat and backrest covered with expanded polyuretane foam.
- 3- Fabric or leather.
- 4- Black or white soft casters for hard floors.

NOTE: This collection offers the possibility of two-color upholstery, with one color for the seat and another for the back. In this case, always calculate based on the price of the fabric in the higher category.



Needed fabric for material: 1.40 m wide:

- Chair:**
- 1 Colour: total 1.4 m
- 2 Colours: seat 0.9 m / backrest 1.3 m
- Chair with armrest:**
- 1 Colour: total 1.5 m
- 2 Colours: seat 0.9 m / backrest 1.3 m

PYRAMID SWIVEL WITH CASTERS BASE

Chair

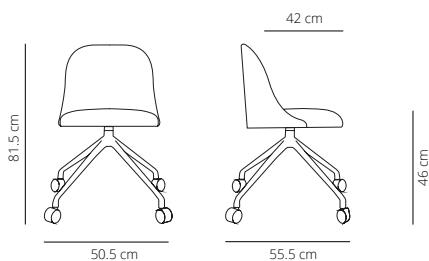

- 📦 13.4 kg
- 📦 (x1) 58x54x88 cm (0.28 m³)

CODE	FINISHES		PUBLIC PRICE
	STRUCTURE	UPHOLSTERY	
ALSIPIRU-1	black or white (microtexturized)	G1 (COM/COL)	5.653 DKK
ALSIPIRU-2		G2	6.136 DKK
ALSIPIRU-3		G3	6.755 DKK
ALSIPIRU-4		G4	7.373 DKK
ALSIPIRU-5		G5	8.102 DKK

Chair with armrest

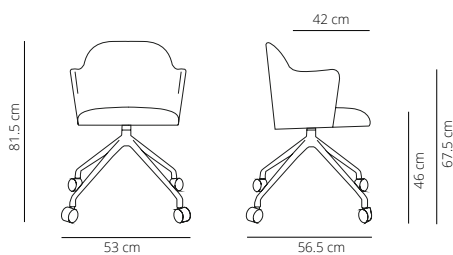

- 📦 14.7 kg
- 📦 (x1) 93x58x55cm (0.3 m³)

CODE	FINISHES		PUBLIC PRICE
	STRUCTURE	UPHOLSTERY	
ALSIPIRUBR-1	black or white (microtexturized)	G1 (COM/COL)	6.543 DKK
ALSIPIRUBR-2		G2	7.111 DKK
ALSIPIRUBR-3		G3	7.831 DKK
ALSIPIRUBR-4		G4	8.619 DKK
ALSIPIRUBR-5		G5	9.450 DKK

Aleta

2017, BY JAIME HAYON

CHAIRS AND STOOLS

Test certificates: ANSI BIFMA X5.4:2012 and UNE-EN 16139:2013vc2015

- 1- Aluminum swivel base powder coated in black or white (high gloss), height adjustment system and black or white soft casters for hard floors*.
- 2- Moulded plywood seat and backrest covered with expanded polyurethane foam.
- 3- Fabric or leather.

*6 weeks production time.

NOTE: When the base is white, the gas lift tube is chrome finished

NOTE: This collection offers the possibility of two-color upholstery, with one color for the seat and another for the back. In this case, always calculate based on the price of the fabric in the higher category.



Needed fabric for material: 1.40 m wide:

Chair:

1 Colour: total 1.4 m

2 Colours: seat 0.9 m / backrest 1.3 m

Chair with armrest:

1 Colour: total 1.5 m

2 Colours: seat 0.9 m / backrest 1.3 m

FIVE CASTERS BASE

Chair

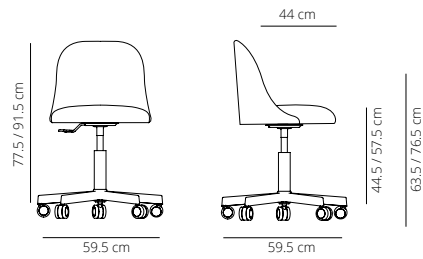

13.4 kg

(x1) 59x53x89 cm (0.28 m³)

CODE	FINISHES		PUBLIC PRICE
	STRUCTURE	UPHOLSTERY	
ALSIBR-1	black or white (high gloss)	G1 (COM/COL)	5.653 DKK
ALSIBR-2		G2	6.136 DKK
ALSIBR-3		G3	6.755 DKK
ALSIBR-4		G4	7.373 DKK
ALSIBR-5		G5	8.102 DKK

Chair with armrest

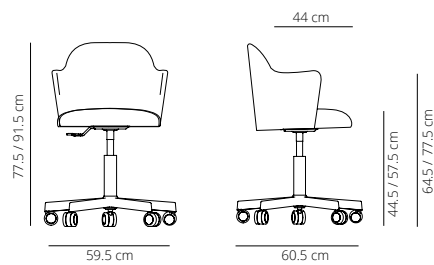

14.5 kg

(x1) 59x53x89 cm (0.28 m³)

CODE	FINISHES		PUBLIC PRICE
	STRUCTURE	UPHOLSTERY	
ALSIBRBR-1	black or white (high gloss)	G1 (COM/COL)	6.543 DKK
ALSIBRBR-2		G2	7.111 DKK
ALSIBRBR-3		G3	7.831 DKK
ALSIBRBR-4		G4	8.619 DKK
ALSIBRBR-5		G5	9.450 DKK

CHAIRS AND STOOLS

Test certificates: ANSI BIFMA X5.4:2012 and UNE-EN 16139:2013vc2015 (without armrest)

- 1- Injected swivel aluminium base powder coated in thermoreinforced polyester in black or white microtexturized.
- 2- Moulded plywood seat and backrest covered with expanded polyuretane foam.
- 3- Fabric or leather.
- 4- Black or translucent plastic glides.

NOTE: This collection offers the possibility of two-color upholstery, with one color for the seat and another for the back. In this case, always calculate based on the price of the fabric in the higher category.



Needed fabric for material: 1.40 m wide:

- Chair:**
 1 Colour: total 1.4 m
 2 Colours: seat 0.9 m / backrest 1.3 m
- Chair with armrest:**
 1 Colour: total 1.5 m
 2 Colours: seat 0.9 m / backrest 1.3 m

FLAT SWIVEL BASE

Chair

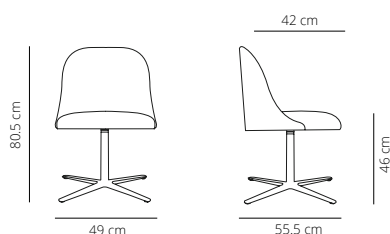

- 👤 13.4 kg
- 📦 (x1) 59x53x89 cm (0.28 m³)

CODE	FINISHES		PUBLIC PRICE
	STRUCTURE	UPHOLSTERY	
ALSIPLA-1	black or white (microtexturized)	G1 (COM/COL)	5.856 DKK
ALSIPLA-2		G2	6.390 DKK
ALSIPLA-3		G3	6.958 DKK
ALSIPLA-4		G4	7.577 DKK
ALSIPLA-5		G5	8.305 DKK

Chair with armrest

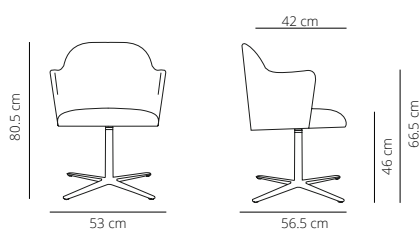

- 👤 14.5 kg
- 📦 (x1) 59x53x89 cm (0.28 m³)

CODE	FINISHES		PUBLIC PRICE
	STRUCTURE	UPHOLSTERY	
ALSIPLABR-1	black or white (microtexturized)	G1 (COM/COL)	6.755 DKK
ALSIPLABR-2		G2	7.314 DKK
ALSIPLABR-3		G3	8.102 DKK
ALSIPLABR-4		G4	8.822 DKK
ALSIPLABR-5		G5	9.653 DKK



+ 4€

*Felt glides available with an upcharge of 4€. If not indicated, the chair will be produced with plastic glides.

Aleta

2017, BY JAIME HAYON

CHAIRS AND STOOLS

Test certificates: UNE-EN 16139:2013vc2015 (without armrest)

- 1- Base in solid oak wood stained with the finishes of our collect ion.
- 2-Moulded plywood seat and backrest covered with expanded polyuretane foam.
- 3- Fabric or leather.
- 4- Plastic glides with or without felt.*

NOTE: This collection offers the possibility of two-color upholstery, with one color for the seat and another for the back. In this case, always calculate based on the price of the fabric in the higher category.



Needed fabric for material: 1.40 m wide:

Chair:

1 Colour: total 1.4 m

2 Colours: seat 0.9 m / backrest 1.3 m

Chair with armrest:

1 Colour: total 1.5 m

2 Colours: seat 0.9 m / backrest 1.3 m

FOUR WOODEN LEGS BASE

Chair

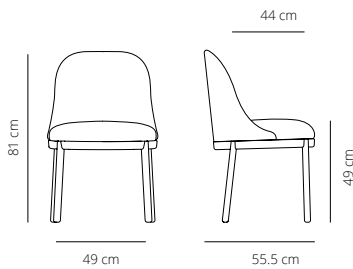

13.4 kg

(x1) 59x53x89 cm (0.28 m³)

CODE	FINISHES		PUBLIC PRICE
	STRUCTURE	UPHOLSTERY	
ALSIMA-1	matt oak, cognac, ash, bleached oak or walnut	G1 (COM/COL)	5.856 DKK
ALSIMA-2		G2	6.390 DKK
ALSIMA-3		G3	6.958 DKK
ALSIMA-4		G4	7.577 DKK
ALSIMA-5		G5	8.305 DKK

Chair with armrest

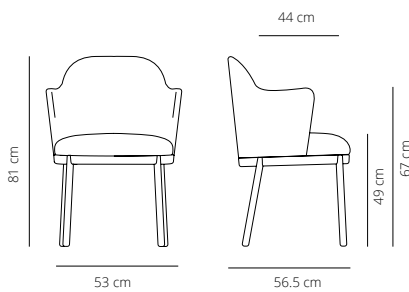

14.5kg

(x1) 59x53x89 cm (0.28 m³)

CODE	FINISHES		PUBLIC PRICE
	STRUCTURE	UPHOLSTERY	
ALSIMABR-1	matt oak, cognac, ash, bleached oak or walnut	G1 (COM/COL)	6.755 DKK
ALSIMABR-2		G2	7.314 DKK
ALSIMABR-3		G3	8.102 DKK
ALSIMABR-4		G4	8.822 DKK
ALSIMABR-5		G5	9.653 DKK

+ 4€

*Felt glides available with an upcharge of 4€. If not indicated, the chair will be produced with plastic glides.

CHAIRS AND STOOLS

Test certificates: ANSI BIFMA X5.4:2012 and UNE-EN 16139:2013vc2015

- 1- Calibrated steel structure with brass finish or powder coated in thermoreinforced polyester in white, black or taupe
- 2-Moulded plywood seat and backrest covered with expanded polyuretane foam.
- 3- Fabric or leather.
- 4- Black or white glides with or without felt.*

NOTE: This collection offers the possibility of two-color upholstery, with one color for the seat and another for the back. In this case, always calculate based on the price of the fabric in the higher category.



Needed fabric for material: 1.40 m wide:
Low backrest:
 1 Colour: total 1.2 m
 2 Colours: seat 0.8 m / backrest 1.1 m
High backrest:
 1 Colour: total 1.3 m
 2 Colours: seat 0.8 m / backrest 1.3 m

FIXED COUNTER STOOL BASE

Low backrest

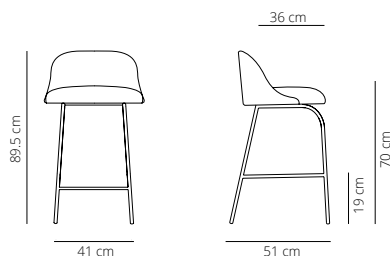

📦 12.4 kg
 📦 (x1) 57.5x53.5x110cm (0.33 m³)

CODE	FINISHES		PUBLIC PRICE
	STRUCTURE	UPHOLSTERY	
ALTAFC-1	black, white or taupe	G1 (COM/COL)	4.568 DKK
ALTAFC-2		G2	5.085 DKK
ALTAFC-3		G3	5.653 DKK
ALTAFC-4		G4	6.390 DKK
ALTAFC-5		G5	7.111 DKK
ALTAFC-1	brass finish	G1 (COM/COL)	8.144 DKK
ALTAFC-2		G2	8.670 DKK
ALTAFC-3		G3	9.246 DKK
ALTAFC-4		G4	9.967 DKK
ALTAFC-5		G5	10.704 DKK

High backrest

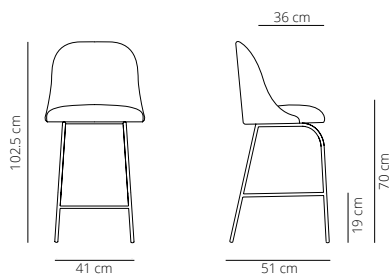

📦 12.7 kg
 📦 (x1) 57.5x53.5x110cm (0.33 m³)

CODE	FINISHES		PUBLIC PRICE
	STRUCTURE	UPHOLSTERY	
ALTAFC-1	black, white or taupe	G1 (COM/COL)	4.678 DKK
ALTAFC-2		G2	5.238 DKK
ALTAFC-3		G3	5.924 DKK
ALTAFC-4		G4	6.687 DKK
ALTAFC-5		G5	7.526 DKK
ALTAFC-1	brass finish	G1 (COM/COL)	8.255 DKK
ALTAFC-2		G2	8.822 DKK
ALTAFC-3		G3	9.500 DKK
ALTAFC-4		G4	10.280 DKK
ALTAFC-5		G5	11.111 DKK



+ 4€ **Felt glides available with an upcharge of 4€. If not indicated, the chair will be produced with plastic glides.*

Aleta

2017, BY JAIME HAYON



CHAIRS AND STOOLS

Test certificate BIFMA X5.4:2012 and
UNE-EN 16139:2013vc2015

Needed fabric for material:
1.40 m wide:
**High backrest with
armrest:**
1 Colour: total 1.6 m
2 Colours: seat 0.8 m /
backrest 1.3 m

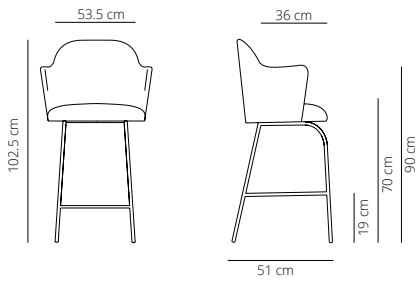
High backrest stool with armrest



 13.8 kg
 (x1) 57.5x53.5x110cm (0.33 m³)

CODE	FINISHES		PUBLIC PRICE
	STRUCTURE	UPHOLSTERY	
ALTAFCHBR-1	black, white or taupe	G1 (COM/COL)	5.399 DKK
ALTAFCHBR-2		G2	6.068 DKK
ALTAFCHBR-3		G3	6.899 DKK
ALTAFCHBR-4		G4	7.789 DKK
ALTAFCHBR-5		G5	8.772 DKK
ALTAFCHBR-1	brass finish	G1 (COM/COL)	8.975 DKK
ALTAFCHBR-2		G2	9.653 DKK
ALTAFCHBR-3		G3	10.492 DKK
ALTAFCHBR-4		G4	11.365 DKK
ALTAFCHBR-5		G5	12.357 DKK

+ 4€ 

*Felt glides available with an upcharge of 4€. If not indicated, the chair will be produced with plastic glides.

CHAIRS AND STOOLS

Test certificates: ANSI BIFMA X5.4:2012 y
UNE-EN 16139:2013vc2015

- 1- Calibrated steel structure with brass finish or powder coated in thermoreinforced polyester in white, black or taupe
- 2-Moulded plywood seat and backrest covered with expanded polyuretane foam.
- 3- Fabric or leather.
- 4- Black or white plastic glides with or without felt.*

NOTE: This collection offers the possibility of two-color upholstery, with one color for the seat and another for the back. In this case, always calculate based on the price of the fabric in the higher category.



Needed fabric for material: 1.40 m wide:
Low backrest:
1 Colour: total 1.2 m
2 Colours: seat 0.8 m / backrest 1.1 m
High backrest:
1 Colour: total 1.3 m
2 Colours: seat 0.8 m / backrest 1.3 m

FIXED BAR STOOL BASE

Low backrest

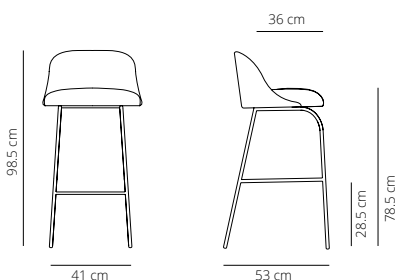

- 📦 12.8 kg
- 📦 (x1) 57.5x53.5x120 cm (0.37 m³)

High backrest

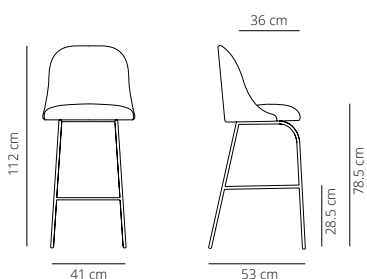

- 📦 13 kg
- 📦 (x1) 57.5x53.5x120 cm (0.37 m³)

CODE	FINISHES		PUBLIC PRICE
	STRUCTURE	UPHOLSTERY	
ALTA-1	black, white or taupe	G1 (COM/COL)	4.568 DKK
ALTA-2		G2	5.085 DKK
ALTA-3		G3	5.653 DKK
ALTA-4		G4	6.390 DKK
ALTA-5		G5	7.111 DKK
ALTA-1	brass finish	G1 (COM/COL)	8.102 DKK
ALTA-2		G2	8.619 DKK
ALTA-3		G3	9.178 DKK
ALTA-4		G4	9.916 DKK
ALTA-5		G5	10.636 DKK

CODE	FINISHES		PUBLIC PRICE
	STRUCTURE	UPHOLSTERY	
ALTAH-1	black, white or taupe	G1 (COM/COL)	4.678 DKK
ALTAH-2		G2	5.238 DKK
ALTAH-3		G3	5.924 DKK
ALTAH-4		G4	6.687 DKK
ALTAH-5		G5	7.526 DKK
ALTAH-1	brass finish	G1 (COM/COL)	8.204 DKK
ALTAH-2		G2	8.772 DKK
ALTAH-3		G3	9.450 DKK
ALTAH-4		G4	10.221 DKK
ALTAH-5		G5	11.051 DKK



+ 4€ **Felt glides available with an upcharge of 4€. If not indicated, the chair will be produced with plastic glides.*

Aleta

2017, BY JAIME HAYON

CHAIRS AND STOOLS

Test certificates: ANSI BIFMA X5.4:2012 and UNE-EN 16139:2013vc2015

Needed fabric for material:
1.40 m wide:
High backrest with armrest:
1 Colour: total 1.6 m
2 Colours: seat 0.8 m / backrest 1.3 m

High backrest with armrest

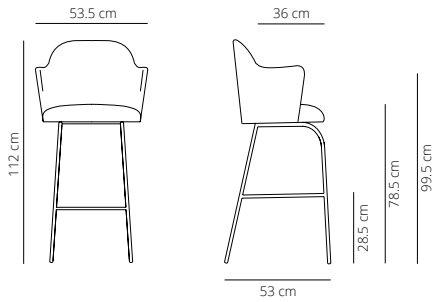

 14.1 kg

 (x1) 57.5x53.5x120 cm (0.37 m³)

CODE	FINISHES		PUBLIC PRICE
	STRUCTURE	UPHOLSTERY	
ALTAHBR-1	black, white or taupe	G1 (COM/COL)	5.399 DKK
ALTAHBR-2		G2	6.068 DKK
ALTAHBR-3		G3	6.899 DKK
ALTAHBR-4		G4	7.789 DKK
ALTAHBR-5		G5	8.772 DKK
ALTAHBR-1	brass finish	G1 (COM/COL)	8.924 DKK
ALTAHBR-2		G2	9.602 DKK
ALTAHBR-3		G3	10.424 DKK
ALTAHBR-4		G4	11.323 DKK
ALTAHBR-5		G5	12.306 DKK

+ 4€ 

*Felt glides available with an upcharge of 4€. If not indicated, the chair will be produced with plastic glides.

CHAIRS AND STOOLS

Test certificates: ANSI BIFMA X5.4:2012 (without armrest)

- 1- Calibrated steel swivel structure powder coated in thermoreinforced polyester in white, black or taupe
- 2- Moulded plywood seat and backrest covered with expanded polyuretane foam.
- 3- Fabric or leather.
- 4- Black or white plastic glides with or without felt.*

NOTE: This collection offers the possibility of two-color upholstery, with one color for the seat and another for the back. In this case, always calculate based on the price of the fabric in the higher category.



Needed fabric for material: 1.40 m wide:
Low backrest:
 1 Colour: total 1.2 m
 2 Colours: seat 0.8 m / backrest 1.1 m
High backrest:
 1 Colour: total 1.3 m
 2 Colours: seat 0.8 m / backrest 1.3 m

SWIVEL COUNTER STOOL BASE

Low backrest

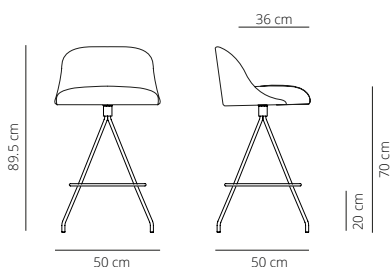

13.1 kg
 (x1) 58x54x106cm (0.33 m³)

High backrest

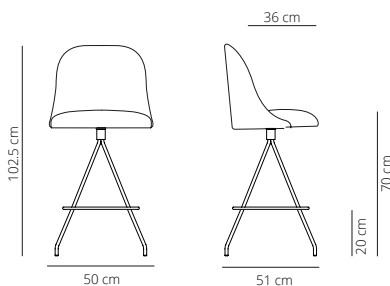

13.4 kg
 (x1) 58x54x110cm (0.34 m³)

CODE	FINISHES		PUBLIC PRICE
	STRUCTURE	UPHOLSTERY	
ALTACO-1	black, white or taupe	G1 (COM/COL)	5.763 DKK
ALTACO-2		G2	6.331 DKK
ALTACO-3		G3	6.899 DKK
ALTACO-4		G4	7.577 DKK
ALTACO-5		G5	8.356 DKK

CODE	FINISHES		PUBLIC PRICE
	STRUCTURE	UPHOLSTERY	
ALTACOH-1	black, white or taupe	G1 (COM/COL)	5.856 DKK
ALTACOH-2		G2	6.483 DKK
ALTACOH-3		G3	7.170 DKK
ALTACOH-4		G4	7.890 DKK
ALTACOH-5		G5	8.772 DKK

+ 4€ *Felt glides available with an upcharge of 4€. If not indicated, the chair will be produced with plastic glides.

Aleta

2017, BY JAIME HAYON

CHAIRS AND STOOLS

Needed fabric for material:
 1.40 m wide:
**High backrest with
 armrest:**
1 Colour: total 1.6 m
2 Colours: seat 0.8 m /
 backrest 1.3 m

High backrest stool with armrest

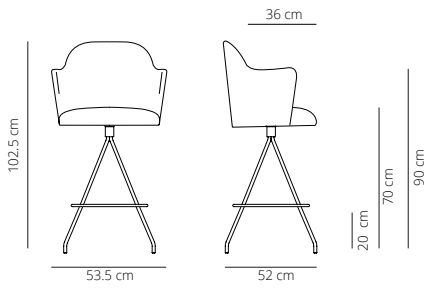

14.1 kg
 (x1) 57.5x53.5x110cm (0.33 m³)

CODE	FINISHES		PUBLIC PRICE
	STRUCTURE	UPHOLSTERY	
ALTACOHBR-1	black, white or taupe	G1 (COM/COL)	6.644 DKK
ALTACOHBR-2		G2	7.314 DKK
ALTACOHBR-3		G3	8.144 DKK
ALTACOHBR-4		G4	9.034 DKK
ALTACOHBR-5		G5	10.017 DKK

+ 4€

*Felt glides available with an upcharge of 4€. If not indicated, the chair will be produced with plastic glides.

CHAIRS AND STOOLS

Test certificates: ANSI BIFMA X5.4:2012 (without armrest)

- 1- Calibrated steel swivel structure powder coated in thermoreinforced polyester in white, black or taupe
- 2-Moulded plywood seat and backrest covered with expanded polyuretane foam.
- 3- Fabric or leather.
- 4- Black or white plastic glides with or without felt.*

NOTE: This collection offers the possibility of two-color upholstery, with one color for the seat and another for the back. In this case, always calculate based on the price of the fabric in the higher category.



Needed fabric for material: 1.40 m wide:
Low backrest:
 1 Colour: total 1.2 m
 2 Colours: seat 0.8 m / backrest 1.1 m
High backrest:
 1 Colour: total 1.3 m
 2 Colours: seat 0.8 m / backrest 1.3 m

SWIVEL BAR STOOL BASE

Low backrest

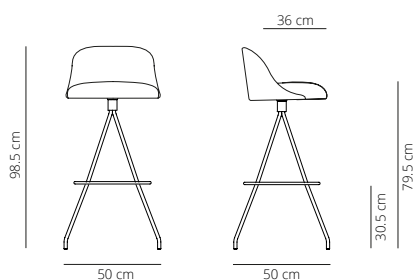

📦 12.1 kg
 📦 (x1) 57.5x53.5x120 cm (0.37 m³)

High backrest

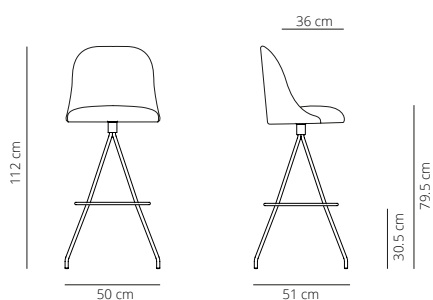

📦 13.6 kg
 📦 (x1) 57.5x53.5x120 cm (0.37 m³)

CODE	FINISHES		PUBLIC PRICE
	STRUCTURE	UPHOLSTERY	
ALTABAR-1	black, white or taupe	G1 (COM/COL)	5.763 DKK
ALTABAR-2		G2	6.331 DKK
ALTABAR-3		G3	6.899 DKK
ALTABAR-4		G4	7.577 DKK
ALTABAR-5		G5	8.356 DKK

CODE	FINISHES		PUBLIC PRICE
	STRUCTURE	UPHOLSTERY	
ALTABARH-1	black, white or taupe	G1 (COM/COL)	5.856 DKK
ALTABARH-2		G2	6.483 DKK
ALTABARH-3		G3	7.170 DKK
ALTABARH-4		G4	7.890 DKK
ALTABARH-5		G5	8.772 DKK



+ 4€ **Felt glides available with an upcharge of 4€. If not indicated, the chair will be produced with plastic glides.*

Needed fabric for material:
 1.40 m wide:
High backrest with armrest:
1 Colour: total 1.6 m
2 Colours: seat 0.8 m /
 backrest 1.3 m

High backrest stool with armrest

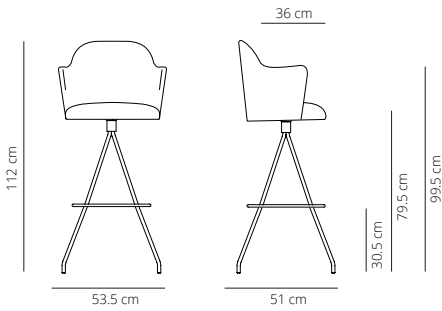

 14.7 kg

 (x1) 57.5x53.5x120 cm (0.37 m³)

CODE	FINISHES		PUBLIC PRICE
	STRUCTURE	UPHOLSTERY	
ALTABARHBR-1	black, white or taupe	G1 (COM/COL)	6.644 DKK
ALTABARHBR-2		G2	7.314 DKK
ALTABARHBR-3		G3	8.144 DKK
ALTABARHBR-4		G4	9.034 DKK
ALTABARHBR-5		G5	10.017 DKK



*Felt glides available with an upcharge of 4€. If not indicated, the chair will be produced with plastic glides.



Maarten Chair

BY VICTOR CARRASCO

CHAIRS AND STOOLS

The powder coated steel tube structure and the carefully made, elegant, upholstered seat of the Maarten chair recall the classics of the '70s. Maarten is available in a wide variety of base and seat finishes to fit with all kind of environments. Fixed upholstery covering available in the soft and smooth versions.

Plastic chairs with four metal legs or sled base can be stacked up to 10 units and up to 4 units for the upholstered chairs. We do not recommend stacking upholstered chairs for long periods of time as it can damage the upholstery.

HIGH BACKREST SEAT OPTIONS

Plastic

Injected polypropylene seat in white, black, dusty green, yellow ochre or brick.

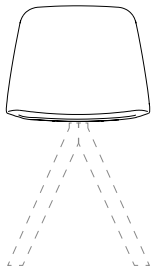

Plastic with cushion

Injected polypropylene seat in white, black, dusty green, yellow ochre or brick with upholstered seat cushion.

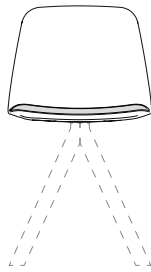

Smooth upholstery

Injected polypropylene seat with smooth upholstery.

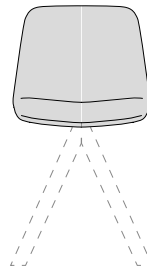

Soft upholstery

Injected polypropylene seat with soft upholstery.

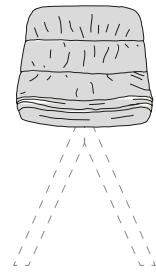

LOW BACKREST SEAT OPTIONS*

*Only available for stools.

Plastic

Injected polypropylene seat in white, black, dusty green, yellow ochre or brick.

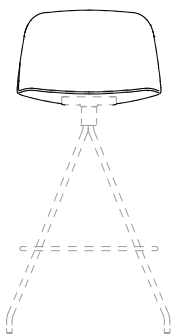

Smooth upholstery

Injected polypropylene seat with smooth upholstery in the finishes of our collection.

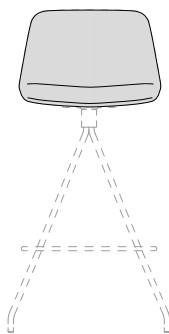

Soft upholstery

Injected polypropylene seat with soft upholstery in the finishes of our collection.

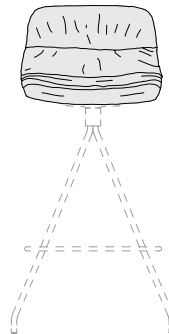

Maarten Chair

2012, BY VICTOR CARRASCO

CHAIRS AND STOOLS

CHAIR BASE OPTIONS

Four metal legs

Calibrated steel structure powder coated in thermoreinforced polyester in white or black. Black or white plastic glides with or without felt.

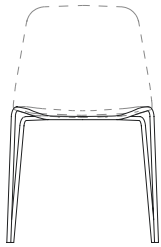

x10 Plastic versions stackable up to 10 units
x4 Upholstered versions stackable up to 4 units

Sled

Calibrated steel structure powder coated in thermoreinforced polyester in white, or black. Black or white plastic glides or black without felt or transparent plastic glides with felt.

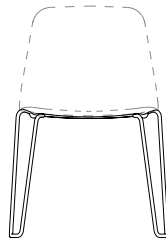

x10 Plastic versions stackable up to 10 units
x4 Upholstered versions stackable up to 4 units

Swivel

Calibrated steel swivel structure powder coated in thermoreinforced polyester in white or black. Clear polypropylene injection glides.

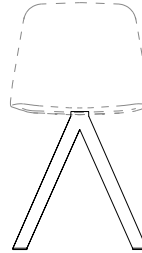

Pyramid swivel

Injected swivel aluminium base powder coated in thermoreinforced polyester in black or white microtexturized. Black or white plastic glides.

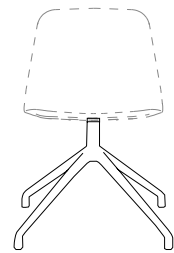

Pyramid swivel with casters

Injected swivel aluminium base powder coated in thermoreinforced polyester in black or white microtexturized with black or white soft casters for hard floors.

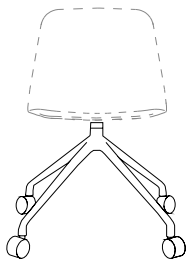

Five casters

Aluminum swivel base powder coated in black or white (high gloss), height adjustment system and black or white soft casters for hard floors*.

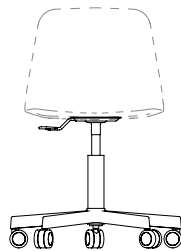

*6 weeks production time.

Flat swivel

Injected swivel aluminium base powder coated in thermoreinforced polyester in black or white microtexturized. Black or translucent plastic glides.

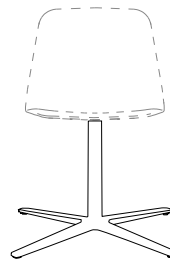

Wooden swivel

Calibrated steel swivel structure with solid oak legs, stained with the finishes of our collection. Black or white plastic glides with or without felt.

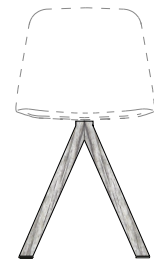

Four wooden legs

Four solid oak wood legs stained with the finishes of our collection. Plastic glides with or without felt.



Four upholstered legs

Four solid oak wood legs upholstered with leather or ecoleather. Plastic glides with or without felt.

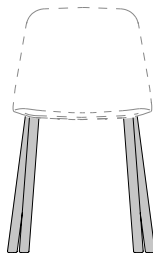

Upholstered swivel

Calibrated steel swivel structure upholstered with leather or ecoleather. Clear polypropylene injection glides.

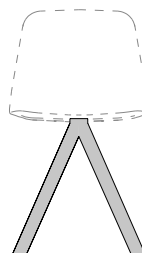

STOOL BASE OPTIONS

Sled counter stool

Calibrated steel structure and footrest powder coated in thermoreinforced polyester in white, or black. Black or white plastic glides or black without felt or transparent plastic glides with felt.

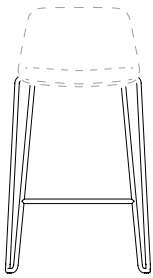

 x4 All versions stackable up to 4 units

Sled bar stool

Calibrated steel structure and footrest powder coated in thermoreinforced polyester in white, or black. Black or white plastic glides or black without felt or transparent plastic glides with felt.

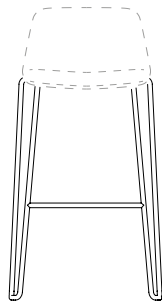

 x4 All versions are stackable up to 4 units

Swivel counter stool

Calibrated steel swivel structure and footrest powder coated in thermoreinforced polyester in white, black. Black or white plastic glides with or without felt.

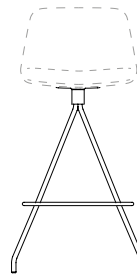

Swivel bar stool

Calibrated steel swivel structure and footrest powder coated in thermoreinforced polyester in white, black. Black or white plastic glides with or without felt.

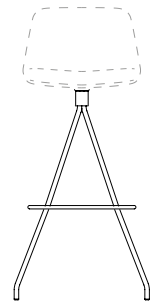

Four wooden legs counter stool

Four solid oak wood legs stained with the finishes for our collection. Calibrated steel footrest powder coated in black thermoreinforced polyester. Plastic glides with or without felt.

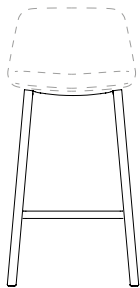

Four wooden legs bar stool

Four solid oak wood legs stained with the finishes for our collection. Calibrated steel footrest powder coated in black thermoreinforced polyester. Plastic glides with or without felt.

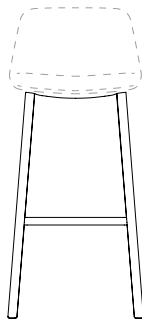

Maarten Chair

2012, BY VICTOR CARRASCO

CHAIRS AND STOOLS

AUDITORIUM SEAT OPTIONS

Plastic

Injected polypropylene seat in white, black, dusty green, yellow ochre or brick. Screws or anchoring system not included.



Plastic with cushion

Injected polypropylene seat in white, black, dusty green, yellow ochre or brick and seat cushion. Screws or anchoring system not included.



Smooth upholstery

Injected polypropylene seat in smooth upholstery. Screws or anchoring system not included.

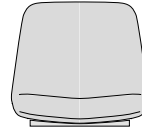

Soft upholstery

Injected polypropylene seat in soft upholstery. Screws or anchoring system not included.

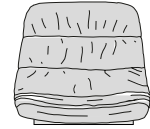

ARMREST OPTIONS

Armrest

Calibrated steel armrest powder coated in thermoreinforced polyester in black or white.

Available for all bases and seats but the auditorium base.

Not available for low backrest stools.

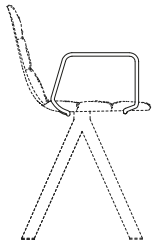

Wooden armrest

Calibrated steel armrest powder coated in thermoreinforced polyester in black or white, with natural oak armrests stained with the finishes of our collection.

Available for all bases and seats but the auditorium base.

Not available for low backrest stools.

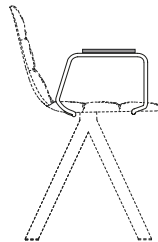

Upholstered armrest

Calibrated steel armrest powder coated in thermoreinforced polyester in black, white and upholstered with leather or ecoleather armrest.

Available for all bases and seats but the auditorium base.

Not available for low backrest stools.

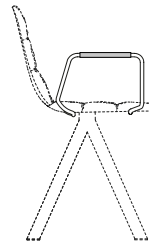

ACCESSORIES

Side table

HPL sidetable with aluminum mechanism and anti-panic system. Left or right versions. Available only for four metal legs base.

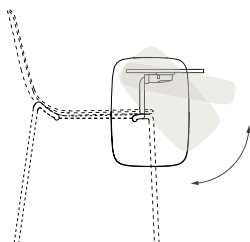

CHAIRS AND STOOLS

Test certificates: ANSI BIFMA X5.4:2012 and UNE-EN 16139:2013vc2015

Calibrated steel structure powder coated in thermoreinforced polyester in white, black, taupe or fluorescent orange. Black or white plastic glides with or without felt.*

Needed fabric for material:

1.40 m wide:

Cushion: 0.7 m

FOUR METAL LEGS BASE

Plastic

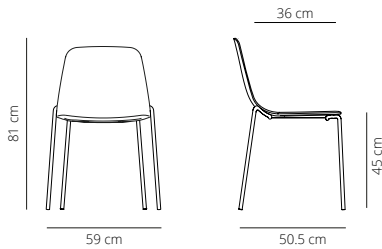

20 kg
(x1) 61x61x99 cm (0.37 m³)

x10 Stackable up to 10 units.

Plastic with cushion

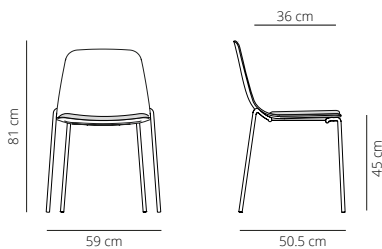

10 kg
(x1) 61x61x99 cm (0.37 m³)

x4 Stackable up to 4 units.

CODE	FINISHES		PUBLIC PRICE
	STRUCTURE	SEAT	
MAAPL4P	white, black	white, black, taupe, dusty green, yellow ochre or brick	1.356 DKK
	taupe or fluorescent orange	white, black, taupe, dusty green, yellow ochre or brick	1.653 DKK

NOTE: Price per unit.

CODE	FINISHES			PUBLIC PRICE
	STRUCTURE	SEAT	UPHOLSTERY	
MAAPL4PC-1	white, black	white, black, taupe, dusty green, yellow ochre or brick	G1 (T/C)	2.026 DKK
MAAPL4PC-2			G2	2.127 DKK
MAAPL4PC-3			G3	2.280 DKK
MAAPL4PC-4			G4	2.542 DKK
MAAPL4PC-5			G5	2.814 DKK
MAAPL4PC-1	taupe or fluorescent orange	white, black, taupe, dusty green, yellow ochre or brick	G1 (T/C)	2.127 DKK
MAAPL4PC-2			G2	2.331 DKK
MAAPL4PC-3			G3	2.441 DKK
MAAPL4PC-4			G4	2.602 DKK
MAAPL4PC-5			G5	2.856 DKK

+ 4€ 

*Felt glides available with an upcharge of 4€. If not indicated, the chair will be produced with plastic glides.

Needed fabric for material:
1.40 m wide:
Smooth upholstery: 1.1 m
Soft upholstery: 1.1 m

Smooth upholstery

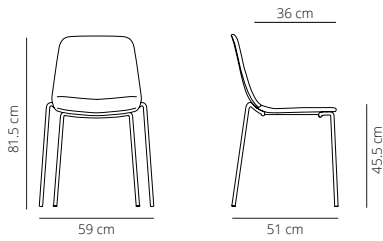

10 kg
(x1) 58x54x88 cm (0.28 m³)

x4 Stackable up to
4 units.

CODE	FINISHES		PUBLIC PRICE
	STRUCTURE	UPHOLSTERY	
MAAL4P-1	white, black	G1 (T/C)	2.602 DKK
MAAL4P-2		G2	2.907 DKK
MAAL4P-3		G3	3.170 DKK
MAAL4P-4		G4	3.475 DKK
MAAL4P-5		G5	3.848 DKK
MAAL4P-1	taupe or fluorescent orange	G1 (T/C)	3.365 DKK
MAAL4P-2		G2	3.636 DKK
MAAL4P-3		G3	3.898 DKK
MAAL4P-4		G4	4.204 DKK
MAAL4P-5		G5	4.610 DKK

Soft upholstery

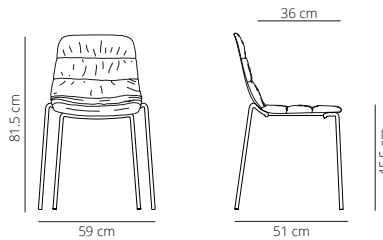

10.3 kg
(x1) 58x54x88 cm (0.28 m³)

x4 Stackable up to
4 units.

CODE	FINISHES		PUBLIC PRICE
	STRUCTURE	UPHOLSTERY	
MAA4P-1	white, black	G1 (T/C)	3.009 DKK
MAA4P-2		G2	3.322 DKK
MAA4P-3		G3	3.636 DKK
MAA4P-4		G4	3.992 DKK
MAA4P-5		G5	4.415 DKK
MAA4P-1	taupe or fluorescent orange	G1 (T/C)	3.737 DKK
MAA4P-2		G2	4.051 DKK
MAA4P-3		G3	4.356 DKK
MAA4P-4		G4	4.780 DKK
MAA4P-5		G5	5.187 DKK



+ 4€ *Felt glides available with an upcharge of 4€. If not indicated, the chair will be produced with plastic glides.

Maarten Chair

2012, BY VICTOR CARRASCO

CHAIRS AND STOOLS

Test certificates: ANSI BIFMA X5.4:2012 and UNE-EN 16139:2013vc2015

Calibrated steel structure powder coated in thermoreinforced polyester in white, or black. Black or white plastic glides or black without felt or transparent plastic glides with felt.*

Needed fabric for material:

1.40 m wide:

Cushion: 0.7 m

SLED BASE

Plastic

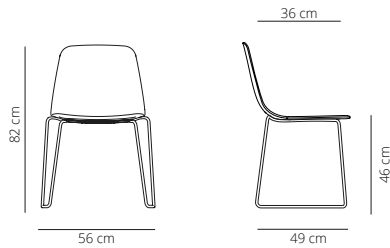

📦 22 kg
 📦 (x1) 61x61x99cm (0.37 m³)

📦 x10 Stackable up to 10 units.

CODE	FINISHES		PUBLIC PRICE
	STRUCTURE	SEAT	
MAAPLPT	white, black	white, black, taupe, dusty green, yellow ochre or brick	1.500 DKK

NOTE: Price per unit.

Plastic with cushion

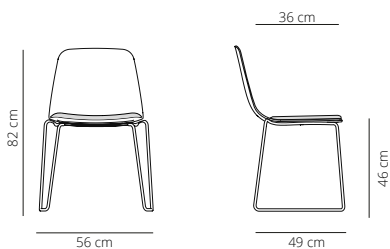

📦 9.2 kg
 📦 (x1) 62x55x88 cm (0.30 m³)

📦 x4 Stackable up to 4 units.

CODE	FINISHES			PUBLIC PRICE
	STRUCTURE	SEAT	UPHOLSTERY	
MAAPLPTC-1	white, black	white, black, taupe, dusty green, yellow ochre or brick	G1 (T/C)	2.187 DKK
MAAPLPTC-2			G2	2.280 DKK
MAAPLPTC-3			G3	2.441 DKK
MAAPLPTC-4			G4	2.704 DKK
MAAPLPTC-5			G5	2.907 DKK

+ 4€ 

*Felt glides available with an upcharge of 4€. If not indicated, the chair will be produced with plastic glides.

Maarten Chair



2012, BY VICTOR CARRASCO

CHAIRS AND STOOLS

Needed fabric for material:
1.40 m wide:
Smooth upholstery: 1.1 m
Soft upholstery: 1.1 m

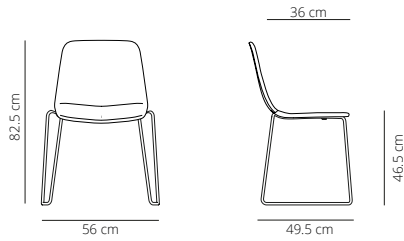
Smooth upholstery





-  9.2 kg
-  (x1) 58x54x88 cm (0.28 m³)
-  ^{x4} Stackable up to 4 units.

CODE	FINISHES		PUBLIC PRICE
	STRUCTURE	UPHOLSTERY	
MAALPT-1	white, black	G1 (T/C)	2.907 DKK
MAALPT-2		G2	3.170 DKK
MAALPT-3		G3	3.432 DKK
MAALPT-4		G4	3.737 DKK
MAALPT-5		G5	4.102 DKK

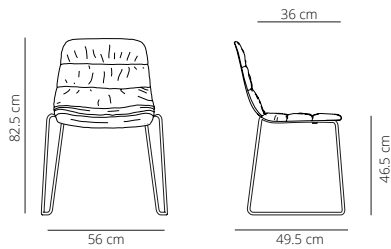
Soft upholstery



-  9.5 kg
-  (x1) 58x54x88 cm (0.28 m³)
-  ^{x4} Stackable up to 4 units.

CODE	FINISHES		PUBLIC PRICE
	STRUCTURE	UPHOLSTERY	
MAAPT-1	white, black	G1 (T/C)	3.271 DKK
MAAPT-2		G2	3.576 DKK
MAAPT-3		G3	3.898 DKK
MAAPT-4		G4	4.254 DKK
MAAPT-5		G5	4.721 DKK



+ 4€

*Felt glides available with an upcharge of 4€. If not indicated, the chair will be produced with plastic glides.

Maarten Chair

2012, BY VICTOR CARRASCO

CHAIRS AND STOOLS

Test certificates: ANSI/BIFMA X5.4-2020 and UNE-EN 16139:2013vc2015 (only without armrest)

Four solid oak wood legs stained with the finishes of our collection. Plastic glides with or without felt.*

Needed fabric for material:

1.40 m wide:

Cushion: 0.7 m

FOUR WOODEN LEGS BASE

Plastic

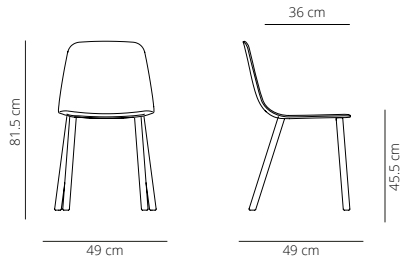

8 kg

(x1) 55x55x88 cm (0.27 m³)

CODE	FINISHES		PUBLIC PRICE
	STRUCTURE	SEAT	
MAAPL4PM	matt oak, cognac, ash, bleached oak or walnut	white, black, taupe, dusty green, yellow ochre or brick	2.602 DKK

Plastic with cushion

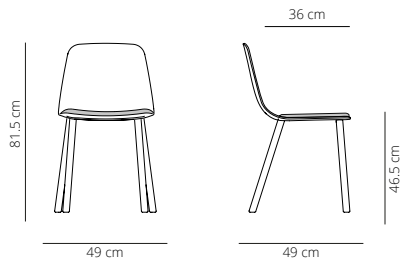

8.3 kg

(x1) 55x55x88 cm (0.27 m³)

CODE	FINISHES			PUBLIC PRICE
	STRUCTURE	SEAT	UPHOLSTERY	
MAAPL4PMC-1	matt oak, cognac, ash, bleached oak or walnut	white, black, taupe, dusty green, yellow ochre or brick	G1 (T/C)	3.322 DKK
MAAPL4PMC-2			G2	3.432 DKK
MAAPL4PMC-3			G3	3.576 DKK
MAAPL4PMC-4			G4	3.788 DKK
MAAPL4PMC-5			G5	3.992 DKK

+ 4€ 

*Felt glides available with an upcharge of 4€. If not indicated, the chair will be produced with plastic glides.

Needed fabric for material:
1.40 m wide:
Smooth upholstery: 1.1 m
Soft upholstery: 1.1 m

Smooth upholstery

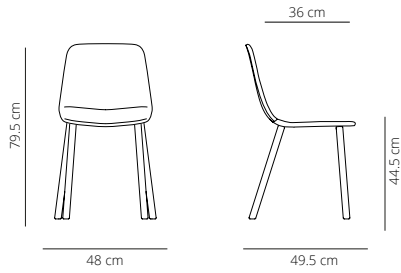

8.3 kg
(x1) 55x55x88 cm (0.27 m³)

CODE	FINISHES		PUBLIC PRICE
	STRUCTURE	UPHOLSTERY	
MAAL4PM-1	matt oak, cognac, ash, bleached oak or walnut	G1 (T/C)	3.788 DKK
MAAL4PM-2		G2	3.941 DKK
MAAL4PM-3		G3	4.254 DKK
MAAL4PM-4		G4	4.678 DKK
MAAL4PM-5		G5	5.034 DKK

Soft upholstery

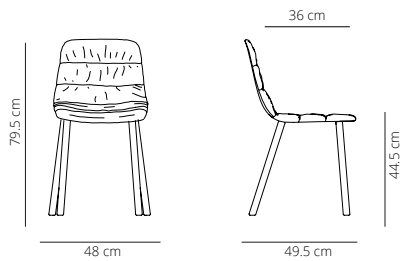

8.6 kg
(x1) 55x55x88 cm (0.27 m³)

CODE	FINISHES		PUBLIC PRICE
	STRUCTURE	UPHOLSTERY	
MAA4PM-1	matt oak, cognac, ash, bleached oak or walnut	G1 (T/C)	4.314 DKK
MAA4PM-2		G2	4.568 DKK
MAA4PM-3		G3	4.932 DKK
MAA4PM-4		G4	5.297 DKK
MAA4PM-5		G5	5.712 DKK



+ 4€ **Felt glides available with an upcharge of 4€. If not indicated, the chair will be produced with plastic glides.*

Maarten Chair

2012, BY VICTOR CARRASCO

CHAIRS AND STOOLS

Test certificates: UNE-EN 16139:2013vc2015 (only without armrest)

Calibrated steel swivel structure powder coated in thermoreinforced polyester in white, black, taupe or fluorescent orange. Clear polypropylene injection glides.

Needed fabric for material:

1.40 m wide:

Cushion: 0.7 m

SWIVEL BASE

Plastic

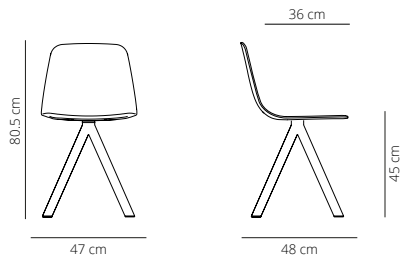

9.9 kg
(x1) 52x52x84cm (0.23 m³)

CODE	FINISHES		PUBLIC PRICE
	STRUCTURE	SEAT	
MAAPL	white, black	white, black, taupe, dusty green, yellow ochre or brick	2.704 DKK
	taupe or fluorescent orange	white, black, taupe, dusty green, yellow ochre or brick	3.365 DKK

Plastic with cushion

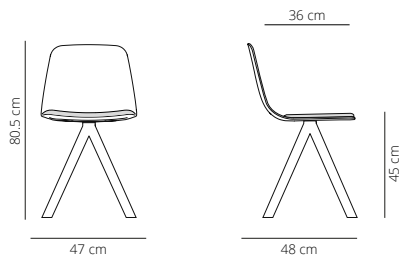

10.2 kg
(x1) 52x52x84 cm (0.23 m³)

CODE	FINISHES			PUBLIC PRICE
	STRUCTURE	SEAT	UPHOLSTERY	
MAAPLC-1	white, black	white, black, taupe, dusty green, yellow ochre or brick	G1 (T/C)	3.365 DKK
MAAPLC-2			G2	3.475 DKK
MAAPLC-3			G3	3.636 DKK
MAAPLC-4			G4	3.848 DKK
MAAPLC-5			G5	4.051 DKK
MAAPLC-1	taupe or fluorescent orange	white, black, taupe, dusty green, yellow ochre or brick	G1 (T/C)	3.475 DKK
MAAPLC-2			G2	4.051 DKK
MAAPLC-3			G3	4.153 DKK
MAAPLC-4			G4	4.314 DKK
MAAPLC-5			G5	4.568 DKK

Maarten Chair

2012, BY VICTOR CARRASCO

CHAIRS AND STOOLS

Needed fabric for material:
1.40 m wide:
Smooth upholstery: 1.1 m
Soft upholstery: 1.1 m

Smooth upholstery

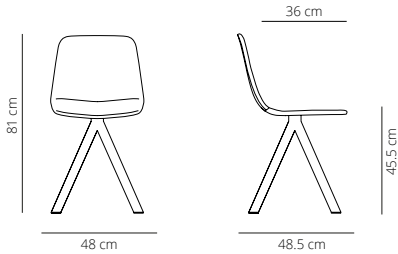

10.2 kg

(x1) 52x52x84cm (0.23 m³)

CODE	FINISHES		PUBLIC PRICE
	STRUCTURE	UPHOLSTERY	
MAAL-1	white, black	G1 (T/C)	4.204 DKK
MAAL-2		G2	4.526 DKK
MAAL-3		G3	4.780 DKK
MAAL-4		G4	5.085 DKK
MAAL-5		G5	5.449 DKK
MAAL-1	taupe or fluorescent orange	G1 (T/C)	5.297 DKK
MAAL-2		G2	5.560 DKK
MAAL-3		G3	5.814 DKK
MAAL-4		G4	6.136 DKK
MAAL-5		G5	6.543 DKK

Soft upholstery

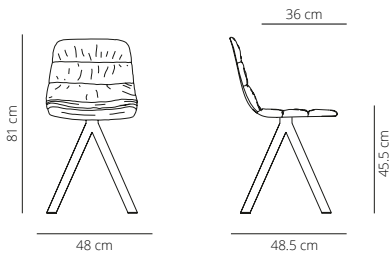

10.5 kg

(x1) 52x52x84cm (0.23 m³)

CODE	FINISHES		PUBLIC PRICE
	STRUCTURE	UPHOLSTERY	
MAA-1	white, black	G1 (T/C)	4.610 DKK
MAA-2		G2	4.932 DKK
MAA-3		G3	5.238 DKK
MAA-4		G4	5.602 DKK
MAA-5		G5	6.026 DKK
MAA-1	taupe or fluorescent orange	G1 (T/C)	5.653 DKK
MAA-2		G2	5.966 DKK
MAA-3		G3	6.331 DKK
MAA-4		G4	6.687 DKK
MAA-5		G5	7.111 DKK

CHAIRS AND STOOLS

Test certificates: UNE-EN 16139:2013vc2015 (only without armrest)

Needed fabric for material:

1.40 m wide:

Cushion: 0.7 m

Injected swivel aluminium base powder coated in thermoreinforced polyester in black or white microtexturized. Black or translucent plastic glides, with or without felt*

PYRAMID SWIVEL BASE

Plastic

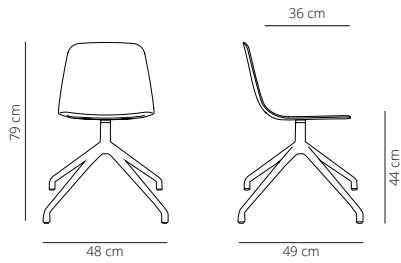

📦 9.3 kg
 📦 (x1) 52x52x84cm (0.23 m³)

CODE	FINISHES		PUBLIC PRICE
	STRUCTURE	SEAT	
MAAPLPI	white, black (microtexturized)	white, black, taupe, dusty green, yellow ochre or brick	2.907 DKK

Plastic with cushion

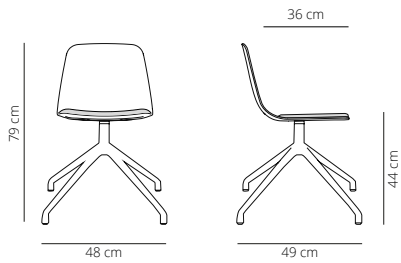

📦 9.6 kg
 📦 (x1) 52x52x84 cm (0.23 m³)

CODE	FINISHES			PUBLIC PRICE
	STRUCTURE	SEAT	UPHOLSTERY	
MAAPLPI-1	white, black (microtexturized)	white, black, taupe, dusty green, yellow ochre or brick	G1 (T/C)	3.576 DKK
MAAPLPI-2			G2	3.687 DKK
MAAPLPI-3			G3	3.848 DKK
MAAPLPI-4			G4	4.051 DKK
MAAPLPI-5			G5	4.254 DKK



+ 4€

*Felt glides available with an upcharge of 4€. If not indicated, the chair will be produced with plastic glides.

Maarten Chair

2012, BY VICTOR CARRASCO

CHAIRS AND STOOLS

Needed fabric for material:
1.40 m wide:
Smooth upholstery: 1.1 m
Soft upholstery: 1.1 m

Smooth upholstery

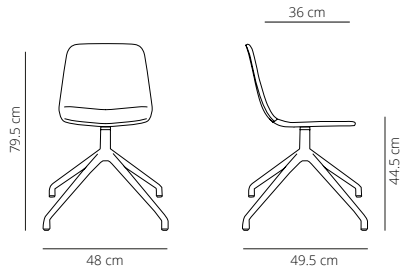

9.6 kg

(x1) 52x52x84cm (0.23 m³)

CODE	FINISHES		PUBLIC PRICE
	STRUCTURE	UPHOLSTERY	
MAALPI-1	white, black (microtexturized)	G1 (T/C)	4.610 DKK
MAALPI-2		G2	4.890 DKK
MAALPI-3		G3	5.144 DKK
MAALPI-4		G4	5.449 DKK
MAALPI-5		G5	5.814 DKK

Soft upholstery

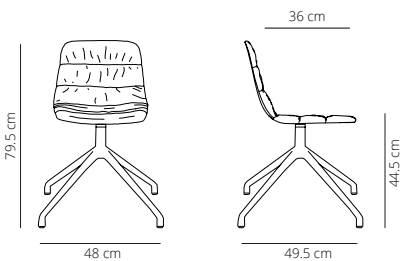

9.9 kg

(x1) 52x52x84cm (0.23 m³)

CODE	FINISHES		PUBLIC PRICE
	STRUCTURE	UPHOLSTERY	
MAAPI-1	white, black (microtexturized)	G1 (T/C)	4.983 DKK
MAAPI-2		G2	5.297 DKK
MAAPI-3		G3	5.602 DKK
MAAPI-4		G4	5.966 DKK
MAAPI-5		G5	6.433 DKK



+ 4€

*Felt glides available with an upcharge of 4€. If not indicated, the chair will be produced with plastic glides.

CHAIRS AND STOOLS

Test certificates: UNE-EN 16139:2013vc2015 (only without armrest)

Injected swivel aluminium base powder coated in thermoreinforced polyester in black or white microtexturized with black or white soft casters for hard floors.

Needed fabric for material:

1.40 m wide:

Cushion: 0.7 m

PYRAMID SWIVEL WITH CASTERS BASE

Plastic

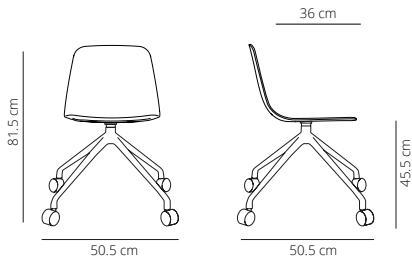

9.8 kg
(x1) 58x54x88 cm (0.28 m³)

CODE	FINISHES		PUBLIC PRICE
	STRUCTURE	SEAT	
MAAPLPIRU	white, black (microtexturized)	white, black, taupe, dusty green, yellow ochre or brick	3.068 DKK

Plastic with cushion

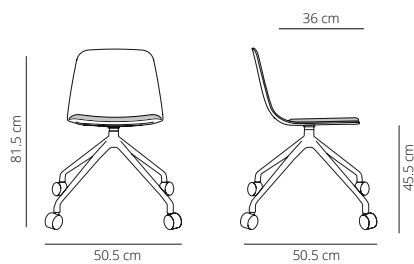

10.1 kg
(x1) 58X54X88 cm (0.28 m³)

CODE	FINISHES			PUBLIC PRICE
	STRUCTURE	SEAT	UPHOLSTERY	
MAAPLPIRUC-1	white, black (microtexturized)	white, black, taupe, dusty green, yellow ochre or brick	G1 (T/C)	3.737 DKK
MAAPLPIRUC-2			G2	3.848 DKK
MAAPLPIRUC-3			G3	3.992 DKK
MAAPLPIRUC-4			G4	4.204 DKK
MAAPLPIRUC-5			G5	4.415 DKK

Maarten Chair

2012, BY VICTOR CARRASCO

CHAIRS AND STOOLS

Needed fabric for material:
1.40 m wide:
Smooth upholstery: 1.1 m
Soft upholstery: 1.1 m

Smooth upholstery

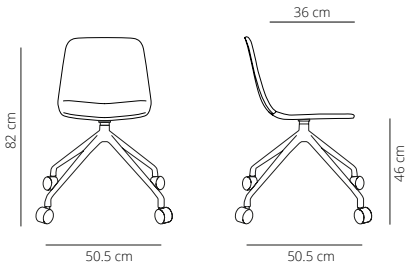

10.1 kg
(x1) 58x54x88 cm (0.28 m³)

CODE	FINISHES		PUBLIC PRICE
	STRUCTURE	UPHOLSTERY	
MAALPIRU-1	white, black (microtexturized)	G1 (T/C)	4.780 DKK
MAALPIRU-2		G2	5.034 DKK
MAALPIRU-3		G3	5.297 DKK
MAALPIRU-4		G4	5.602 DKK
MAALPIRU-5		G5	5.966 DKK

Soft upholstery

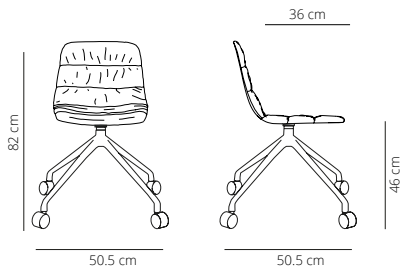

10.4 kg
(x1) 58x54x88 cm (0.28 m³)

CODE	FINISHES		PUBLIC PRICE
	STRUCTURE	UPHOLSTERY	
MAAPIRU-1	white, black (microtexturized)	G1 (T/C)	5.144 DKK
MAAPIRU-2		G2	5.449 DKK
MAAPIRU-3		G3	5.763 DKK
MAAPIRU-4		G4	6.136 DKK
MAAPIRU-5		G5	6.594 DKK

CHAIRS AND STOOLS

Aluminum swivel base powder coated in black or white (high gloss), height adjustment system and black or white soft casters for hard floors*.

*6 weeks production time.

NOTE: When the base is white, the gas lift tube is chrome finished

Needed fabric for material:

1.40 m wide:

Cushion: 0.7 m

FIVE CASTERS BASE

Plastic

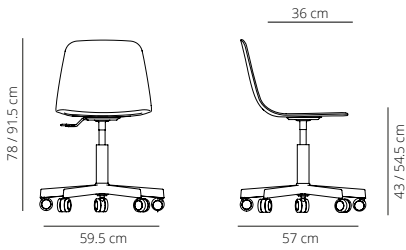

📦 10.4 kg

📦 (x1) 52x52x84cm (0.23 m³)

CODE	FINISHES		PUBLIC PRICE
	STRUCTURE	SEAT	
MAAPLBR	white, black (high gloss)	white, black, taupe, dusty green, yellow ochre or brick	3.068 DKK

Plastic with cushion

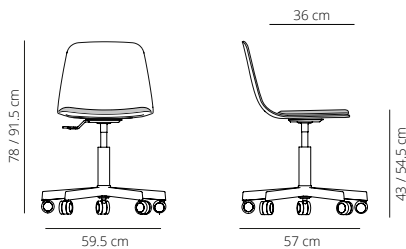

📦 10.7 kg

📦 (x1) 52x52x84 cm (0.23 m³)

CODE	FINISHES			PUBLIC PRICE
	STRUCTURE	SEAT	UPHOLSTERY	
MAAPLBR-1	white, black (high gloss)	white, black, taupe, dusty green, yellow ochre or brick	G1 (T/C)	3.737 DKK
MAAPLBR-2			G2	3.848 DKK
MAAPLBR-3			G3	3.992 DKK
MAAPLBR-4			G4	4.204 DKK
MAAPLBR-5			G5	4.415 DKK

Needed fabric for material:
1.40 m wide:
Smooth upholstery: 1.1 m
Soft upholstery: 1.1 m

Smooth upholstery

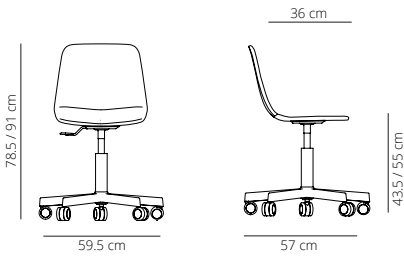

10.7 kg
(x1) 52x52x84cm (0.23 m³)

CODE	FINISHES		PUBLIC PRICE
	STRUCTURE	UPHOLSTERY	
MAALBR-1	white, black (high gloss)	G1 (T/C)	4.780 DKK
MAALBR-2		G2	5.034 DKK
MAALBR-3		G3	5.297 DKK
MAALBR-4		G4	5.602 DKK
MAALBR-5		G5	5.966 DKK

Soft upholstery

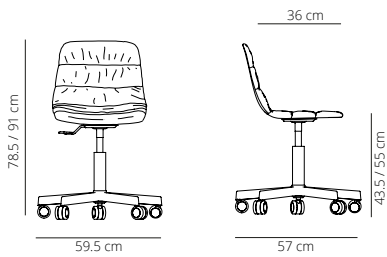

11 kg
(x1) 52x52x84cm (0.23 m³)

CODE	FINISHES		PUBLIC PRICE
	STRUCTURE	UPHOLSTERY	
MAABR-1	white, black (high gloss)	G1 (T/C)	5.144 DKK
MAABR-2		G2	5.449 DKK
MAABR-3		G3	5.763 DKK
MAABR-4		G4	6.136 DKK
MAABR-5		G5	6.594 DKK

Test certificates: UNE-EN 16139:2013vc2015 (only without armrest)

Injected swivel aluminium base powder coated in thermoreinforced polyester in black or white microtexturized. Black or translucent plastic glides.

Needed fabric for material:

1.40 m wide:

Cushion: 0.7 m

FLAT SWIVEL BASE

Plastic

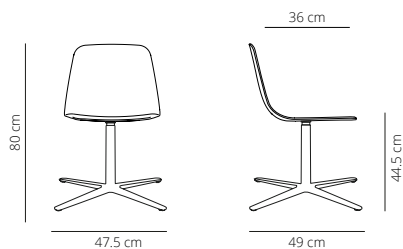

9.4 kg
 (x1) 52x52x84cm (0.23 m³)

CODE	FINISHES		PUBLIC PRICE
	STRUCTURE	SEAT	
MAAPLPLA	white, black (microtexturized)	white, black, taupe, dusty green, yellow ochre or brick	3.271 DKK

Plastic with cushion

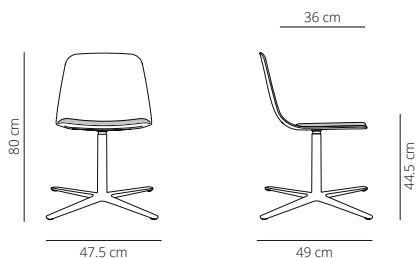

9.7 kg
 (x1) 52x52x84 cm (0.23 m³)

CODE	FINISHES			PUBLIC PRICE
	STRUCTURE	SEAT	UPHOLSTERY	
MAAPLPLAC-1	white, black (microtexturized)	white, black, taupe, dusty green, yellow ochre or brick	G1 (T/C)	3.941 DKK
MAAPLPLAC-2			G2	4.051 DKK
MAAPLPLAC-3			G3	4.204 DKK
MAAPLPLAC-4			G4	4.415 DKK
MAAPLPLAC-5			G5	4.678 DKK



+ 4€

*Felt glides available with an upcharge of 4€. If not indicated, the chair will be produced with plastic glides.

Needed fabric for material:
1.40 m wide:
Smooth upholstery: 1.1 m
Soft upholstery: 1.1 m

Smooth upholstery

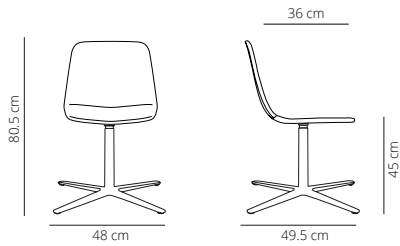

9.7 kg
(x1) 52x52x84cm (0.23 m³)

CODE	FINISHES		PUBLIC PRICE
	STRUCTURE	UPHOLSTERY	
MAALPLA-1	white, black (microtexturized)	G1 (T/C)	5.085 DKK
MAALPLA-2		G2	5.348 DKK
MAALPLA-3		G3	5.602 DKK
MAALPLA-4		G4	5.924 DKK
MAALPLA-5		G5	6.331 DKK

Soft upholstery

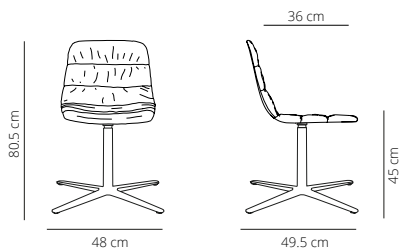

10 kg
(x1) 52x52x84cm (0.23 m³)

CODE	FINISHES		PUBLIC PRICE
	STRUCTURE	UPHOLSTERY	
MAAPLA-1	white, black (microtexturized)	G1 (T/C)	5.449 DKK
MAAPLA-2		G2	5.763 DKK
MAAPLA-3		G3	6.068 DKK
MAAPLA-4		G4	6.483 DKK
MAAPLA-5		G5	6.899 DKK



+ 4€

*Felt glides available with an upcharge of 4€. If not indicated, the chair will be produced with plastic glides.

CHAIRS AND STOOLS

Test certificates: UNE-EN 16139:2013vc2015 (only without armrest)

Needed fabric for material:

1.40 m wide:

Cushion: 0.7 m

Taupe or black lacquered calibrated steel swivel base with four solid oak legs, stained in the finishes of the collection.
Plastic feet with or without felt *.

NOTE: Due to the fact that the wood used is natural, the finish may vary.

WOODEN SWIVEL BASE

Plastic

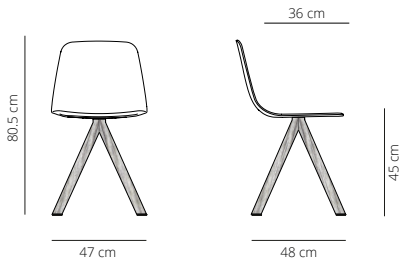

📦 9.9 kg

📦 (x1) 52x52x84cm (0.23 m³)

CODE	FINISHES		PUBLIC PRICE
	STRUCTURE	SEAT	
MAAPLM	matt oak, cognac, ash, bleached oak or walnut	white, black, taupe, dusty green, yellow ochre or brick	4.890 DKK

Plastic with cushion

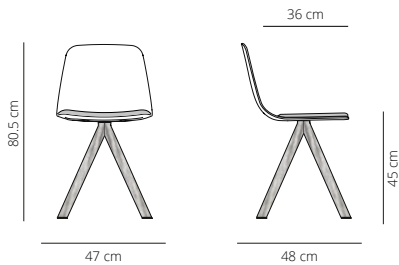

📦 10.2 kg

📦 (x1) 52x52x84 cm (0.23 m³)

CODE	FINISHES			PUBLIC PRICE
	STRUCTURE	SEAT	UPHOLSTERY	
MAAPLMC-1	matt oak, cognac, ash, bleached oak or walnut	white, black, taupe, dusty green, yellow ochre or brick	G1 (T/C)	5.560 DKK
MAAPLMC-2			G2	5.653 DKK
MAAPLMC-3			G3	5.814 DKK
MAAPLMC-4			G4	6.026 DKK
MAAPLMC-5			G5	6.280 DKK



+ 4€

*Felt glides available with an upcharge of 4€. If not indicated, the chair will be produced with plastic glides.

Needed fabric for material:
1.40 m wide:
Smooth upholstery: 1.1 m
Soft upholstery: 1.1 m

Smooth upholstery

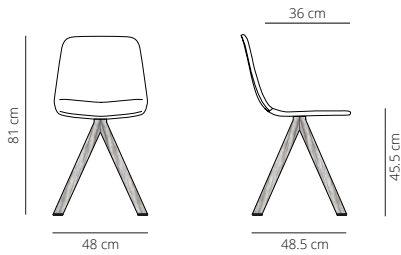

📦 10.2 kg
📦 (x1) 52x52x84cm (0.23 m³)

CODE	FINISHES		PUBLIC PRICE
	STRUCTURE	UPHOLSTERY	
MAALM-1	matt oak, cognac, ash, bleached oak or walnut	G1 (T/C)	6.390 DKK
MAALM-2		G2	6.644 DKK
MAALM-3		G3	6.899 DKK
MAALM-4		G4	7.212 DKK
MAALM-5		G5	7.577 DKK

Soft upholstery

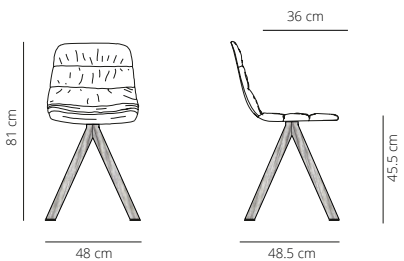

📦 10.5 kg
📦 (x1) 52x52x84cm (0.23 m³)

CODE	FINISHES		PUBLIC PRICE
	STRUCTURE	UPHOLSTERY	
MAAM-1	matt oak, cognac, ash, bleached oak or walnut	G1 (T/C)	6.755 DKK
MAAM-2		G2	7.060 DKK
MAAM-3		G3	7.373 DKK
MAAM-4		G4	7.738 DKK
MAAM-5		G5	8.204 DKK



+ 4€

*Felt glides available with an upcharge of 4€. If not indicated, the chair will be produced with plastic glides.

Maarten Chair

2012, BY VICTOR CARRASCO

CHAIRS AND STOOLS

Test certificates: ANSI BIFMA X5.4:2020 and UNE-EN 16139:2013vc2015

Four solid oak wood legs upholstered with leather or ecoleather. Plastic glides with or without felt.*

Needed fabric for material:

1.40 m wide:

Cushion: 0.7 m

FOUR UPHOLSTERED LEGS BASE

Plastic

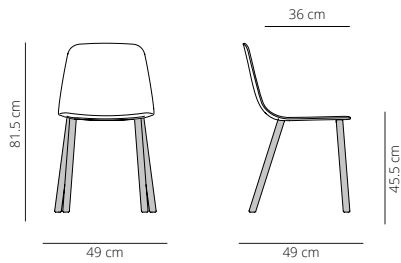

8 kg

(x1) 55x55x88 cm (0.27 m³)

CODE	FINISHES		PUBLIC PRICE
	STRUCTURE	SEAT	
MAAPL4PTP	ecoleather	white, black, taupe, dusty green, yellow ochre or brick	3.941 DKK
MAAPL4PTL	leather	white, black, taupe, dusty green, yellow ochre or brick	4.466 DKK

Plastic with cushion

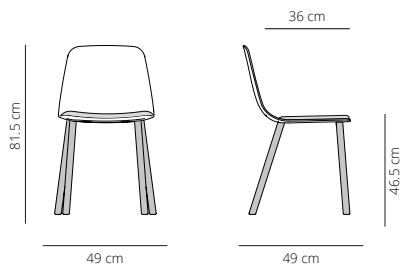

8.3 kg

(x1) 55x55x88 cm (0.27 m³)

CODE	FINISHES			PUBLIC PRICE
	STRUCTURE	SEAT	UPHOLSTERY	
MAAPL4PTPC-1	ecoleather	white, black, taupe, dusty green, yellow ochre or brick	G1 (T/C)	5.034 DKK
MAAPL4PTPC-2			G2	5.144 DKK
MAAPL4PTPC-3			G3	5.297 DKK
MAAPL4PTPC-4			G4	5.509 DKK
MAAPL4PTPC-5			G5	5.712 DKK
MAAPL4PTLC-1	leather	white, black, taupe, dusty green, yellow ochre or brick	G1 (T/C)	5.560 DKK
MAAPL4PTLC-2			G2	5.653 DKK
MAAPL4PTLC-3			G3	5.814 DKK
MAAPL4PTLC-4			G4	6.026 DKK
MAAPL4PTLC-5			G5	6.221 DKK

+ 4€

*Felt glides available with an upcharge of 4€. If not indicated, the chair will be produced with plastic glides.

Needed fabric for material:
1.40 m wide:
Smooth upholstery: 1.1 m
Soft upholstery: 1.1 m

Smooth upholstery

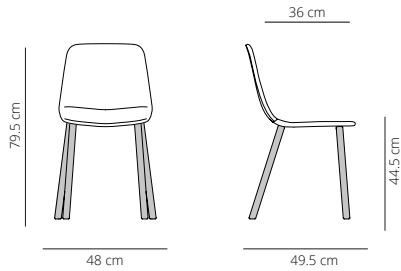

8.3 kg
(x1) 55x55x88 cm (0.27 m³)

CODE	FINISHES		PUBLIC PRICE
	STRUCTURE	UPHOLSTERY	
MAAL4PTP-1	ecoleather	G1 (T/C)	5.856 DKK
MAAL4PTP-2		G2	6.178 DKK
MAAL4PTP-3		G3	6.433 DKK
MAAL4PTP-4		G4	6.755 DKK
MAAL4PTP-5		G5	7.111 DKK
MAAL4PTL-1	leather	G1 (T/C)	6.390 DKK
MAAL4PTL-2		G2	6.687 DKK
MAAL4PTL-3		G3	6.958 DKK
MAAL4PTL-4		G4	7.272 DKK
MAAL4PTL-5		G5	7.636 DKK

Soft upholstery

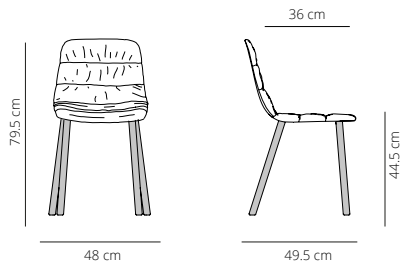

8.6 kg
(x1) 55x55x88 cm (0.27 m³)

CODE	FINISHES		PUBLIC PRICE
	STRUCTURE	UPHOLSTERY	
MAA4PTP-1	ecoleather	G1 (T/C)	6.280 DKK
MAA4PTP-2		G2	6.594 DKK
MAA4PTP-3		G3	6.899 DKK
MAA4PTP-4		G4	7.272 DKK
MAA4PTP-5		G5	7.678 DKK
MAA4PTL-1	leather	G1 (T/C)	6.797 DKK
MAA4PTL-2		G2	7.111 DKK
MAA4PTL-3		G3	7.424 DKK
MAA4PTL-4		G4	7.789 DKK
MAA4PTL-5		G5	8.204 DKK



+ 4€

*Felt glides available with an upcharge of 4€. If not indicated, the chair will be produced with plastic glides.

CHAIRS AND STOOLS

Test certificates: UNE-EN 16139:2013vc2015 (only without armrest)

Calibrated steel swivel structure upholstered with leather or ecoleather.
Clear polypropylene injection glides.

Needed fabric for material:

1.40 m wide:

Cushion: 0.7 m

UPHOLSTERED SWIVEL BASE

Plastic

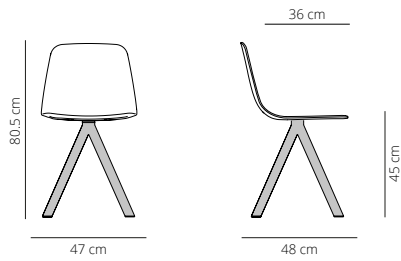

📦 9.9 kg
📦 (x1) 52x52x84cm (0.23 m³)

CODE	FINISHES		PUBLIC PRICE
	STRUCTURE	SEAT	
MAAPLPGTP	ecoleather	white, black, taupe, dusty green, yellow ochre or brick	4.356 DKK
MAAPLPGTL	leather	white, black, taupe, dusty green, yellow ochre or brick	4.890 DKK

Plastic with cushion

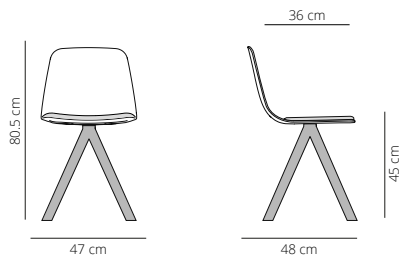

📦 10.2 kg
📦 (x1) 52x52x84 cm (0.23 m³)

CODE	FINISHES			PUBLIC PRICE
	STRUCTURE	SEAT	UPHOLSTERY	
MAAPLPGTPC-1	ecoleather	white, black, taupe, dusty green, yellow ochre or brick	G1 (T/C)	4.678 DKK
MAAPLPGTPC-2			G2	4.780 DKK
MAAPLPGTPC-3			G3	4.932 DKK
MAAPLPGTPC-4			G4	5.144 DKK
MAAPLPGTPC-5			G5	5.348 DKK
MAAPLPGTLC-1	leather	white, black, taupe, dusty green, yellow ochre or brick	G1 (T/C)	5.187 DKK
MAAPLPGTLC-2			G2	5.297 DKK
MAAPLPGTLC-3			G3	5.449 DKK
MAAPLPGTLC-4			G4	5.653 DKK
MAAPLPGTLC-5			G5	5.856 DKK

Needed fabric for material:
1.40 m wide:
Smooth upholstery: 1.1 m
Soft upholstery: 1.1 m

Smooth upholstery

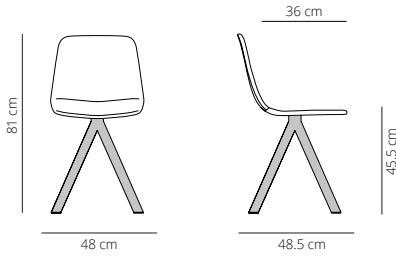

10.2 kg
(x1) 52x52x84cm (0.23 m³)

CODE	FINISHES		PUBLIC PRICE
	STRUCTURE	UPHOLSTERY	
MAALPGTP-1	ecoleather	G1 (T/C)	5.144 DKK
MAALPGTP-2		G2	5.297 DKK
MAALPGTP-3		G3	5.602 DKK
MAALPGTP-4		G4	6.026 DKK
MAALPGTP-5		G5	6.390 DKK
MAALPGTL-1	leather	G1 (T/C)	5.653 DKK
MAALPGTL-2		G2	5.814 DKK
MAALPGTL-3		G3	6.136 DKK
MAALPGTL-4		G4	6.543 DKK
MAALPGTL-5		G5	6.899 DKK

Soft upholstery

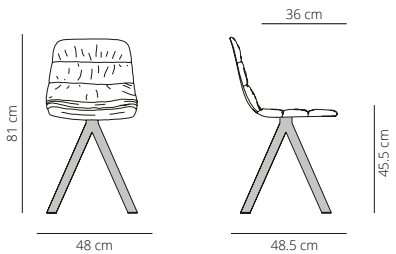

10.5 kg
(x1) 52x52x84cm (0.23 m³)

CODE	FINISHES		PUBLIC PRICE
	STRUCTURE	UPHOLSTERY	
MAAPGTP-1	ecoleather	G1 (T/C)	5.653 DKK
MAAPGTP-2		G2	5.924 DKK
MAAPGTP-3		G3	6.280 DKK
MAAPGTP-4		G4	6.644 DKK
MAAPGTP-5		G5	7.060 DKK
MAAPGTL-1	leather	G1 (T/C)	6.178 DKK
MAAPGTL-2		G2	6.433 DKK
MAAPGTL-3		G3	6.797 DKK
MAAPGTL-4		G4	7.170 DKK
MAAPGTL-5		G5	7.577 DKK

CHAIRS AND STOOLS

Test certificates: ANSI BIFMA X5.4-2020 and UNE EN 16139:2013vc2015

Calibrated steel structure and footrest powder coated in thermoreinforced polyester in white, or black. Black or white plastic glides or black without felt or transparent plastic glides with felt.*

Needed fabric for material:
1.40 m wide:
Smooth upholstery: 1 m
Soft upholstery: 1 m

SLED COUNTER STOOL BASE

Plastic low backrest

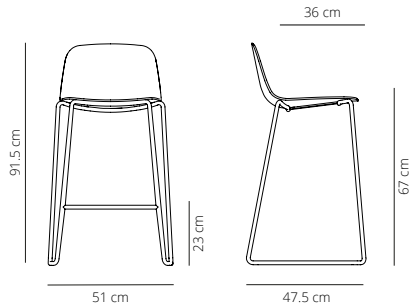

7.9 kg
(x1) 58x56x120 cm (0.39 m³)
x4 Stackable up to 4 units

CODE	FINISHES		PUBLIC PRICE
	STRUCTURE	SEAT	
MAALPTCOB	white, black	white, black, taupe, dusty green, yellow ochre or brick	2.026 DKK

Smooth upholstered low backrest

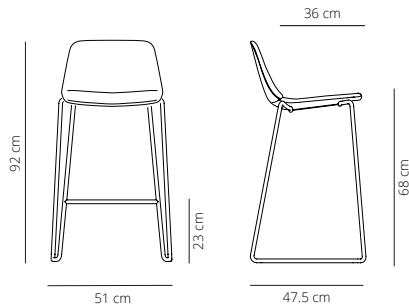

8.4 kg
(x1) 58x56x100 cm (0.32 m³)
x4 Stackable up to 4 units

CODE	FINISHES		PUBLIC PRICE
	STRUCTURE	UPHOLSTERY	
MAALPTCOB-1	white, black	G1 (T/C)	3.170 DKK
MAALPTCOB-2		G2	3.271 DKK
MAALPTCOB-3		G3	3.576 DKK
MAALPTCOB-4		G4	3.848 DKK
MAALPTCOB-5		G5	4.102 DKK

Soft upholstered low backrest

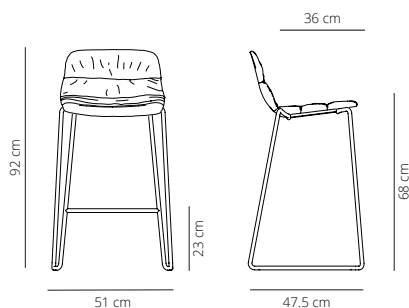

8.6 kg
(x1) 58x56x100 cm (0.32 m³)
x4 Stackable up to 4 units

CODE	FINISHES		PUBLIC PRICE
	STRUCTURE	UPHOLSTERY	
MAATPTCOB-1	white, black	G1 (T/C)	3.534 DKK
MAATPTCOB-2		G2	3.687 DKK
MAATPTCOB-3		G3	3.992 DKK
MAATPTCOB-4		G4	4.314 DKK
MAATPTCOB-5		G5	4.678 DKK

+ 4€ 

*Felt glides available with an upcharge of 4€. If not indicated, the chair will be produced with plastic glides.

Maarten Chair

2012, BY VICTOR CARRASCO

CHAIRS AND STOOLS

Test certificates: ANSI BIFMA X5.4-2020 and UNE EN 16139:2013vc2015

Calibrated steel structure and footrest powder coated in thermoreinforced polyester in white, or black. Black or white plastic glides or black without felt or transparent plastic glides with felt.*

Needed fabric for material:

1.40 m wide:

Smooth upholstery: 1 m

Soft upholstery: 1 m

SLED BAR STOOL BASE

Plastic low backrest

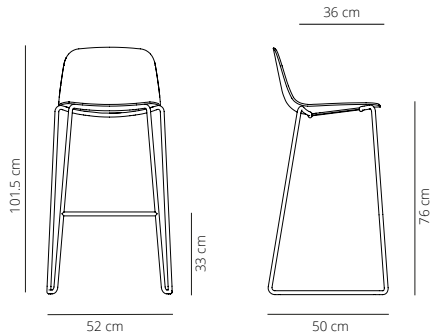

8.4 kg

(x1) 58x56x120 cm (0.35 m³)

x4 Stackable up to 4 units

CODE	FINISHES		PUBLIC PRICE
	STRUCTURE	SEAT	
MAALPTBARB	white, black	white, black, taupe, dusty green, yellow ochre or brick	2.026 DKK

Smooth upholstered low backrest

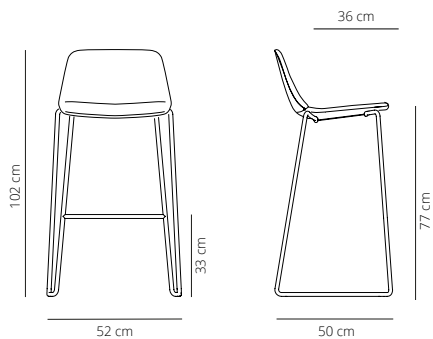

8.8 kg

(x1) 58x56x108 cm (0.35 m³)

x4 Stackable up to 4 units

CODE	FINISHES		PUBLIC PRICE
	STRUCTURE	UPHOLSTERY	
MAALPTBARB-1	white, black	G1 (T/C)	3.170 DKK
MAALPTBARB-2		G2	3.271 DKK
MAALPTBARB-3		G3	3.576 DKK
MAALPTBARB-4		G4	3.848 DKK
MAALPTBARB-5		G5	4.102 DKK

Soft upholstered low backrest

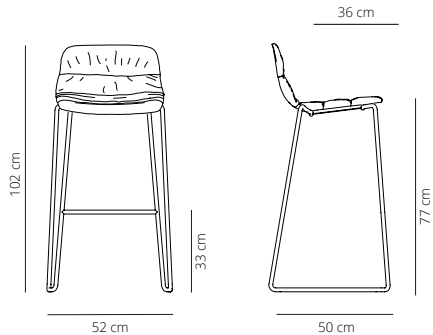

9.0 kg

(x1) 58x56x108 cm (0.35 m³)

x4 Stackable up to 4 units

CODE	FINISHES		PUBLIC PRICE
	STRUCTURE	UPHOLSTERY	
MAALPTBARB-1	white, black	G1 (T/C)	3.534 DKK
MAALPTBARB-2		G2	3.687 DKK
MAALPTBARB-3		G3	3.992 DKK
MAALPTBARB-4		G4	4.314 DKK
MAALPTBARB-5		G5	4.678 DKK



+ 4€

*Felt glides available with an upcharge of 4€. If not indicated, the chair will be produced with plastic glides.

CHAIRS AND STOOLS

Test certificates: ANSI BIFMA X5.4-2020 and UNE EN 16139:2013vc2015

Calibrated steel swivel structure powder coated in thermoreinforced polyester in white, black, taupe or fluorescent orange. Black or white plastic glides with or without felt.*

Needed fabric for material:
1.40 m wide:
Smooth upholstery: 1 m
Soft upholstery: 1 m

SWIVEL COUNTER STOOL BASE

Plastic low backrest

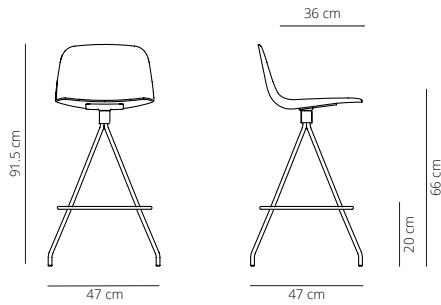

8.4 kg
(x1) 54x54x97 cm (0.28 m³)

Smooth upholstered low backrest

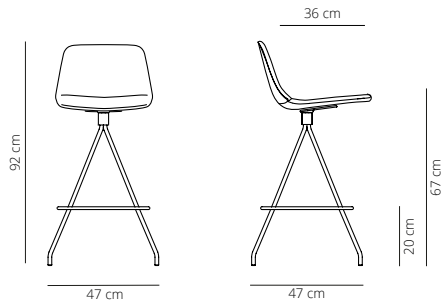

8.8 kg
(x1) 54x54x97 cm (0.28 m³)

Soft upholstered low backrest

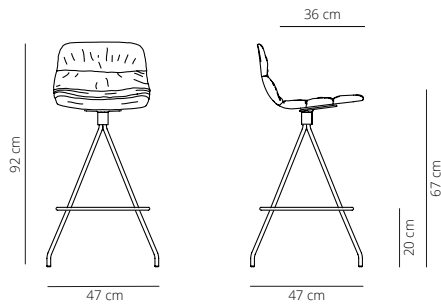

9.0 kg
(x1) 54x54x97 cm (0.28 m³)

CODE	FINISHES		PUBLIC PRICE
	STRUCTURE	SEAT	
MAAPLCOB	white, black	white, black, taupe, dusty green, yellow ochre or brick	2.542 DKK

CODE	FINISHES		PUBLIC PRICE
	STRUCTURE	UPHOLSTERY	
MAALTCOB-1	white, black	G1 (T/C)	3.898 DKK
MAALTCOB-2		G2	4.051 DKK
MAALTCOB-3		G3	4.314 DKK
MAALTCOB-4		G4	4.678 DKK
MAALTCOB-5		G5	4.983 DKK

CODE	FINISHES		PUBLIC PRICE
	STRUCTURE	UPHOLSTERY	
MAATCOB-1	white, black	G1 (T/C)	4.051 DKK
MAATCOB-2		G2	4.204 DKK
MAATCOB-3		G3	4.526 DKK
MAATCOB-4		G4	4.822 DKK
MAATCOB-5		G5	5.144 DKK

+ 4€ 

*Felt glides available with an upcharge of 4€. If not indicated, the chair will be produced with plastic glides.

Maarten Chair

2012, BY VICTOR CARRASCO

CHAIRS AND STOOLS

Test certificates: ANSI BIFMA X5.4-2020 and UNE EN 16139:2013vc2015

Calibrated steel swivel structure powder coated in thermoreinforced polyester in white, black, taupe or fluorescent orange. Black or white plastic glides with or without felt.*

Needed fabric for material:
1.40 m wide:
Smooth upholstery: 1 m
Soft upholstery: 1 m

SWIVEL BAR STOOL BASE

Plastic low backrest

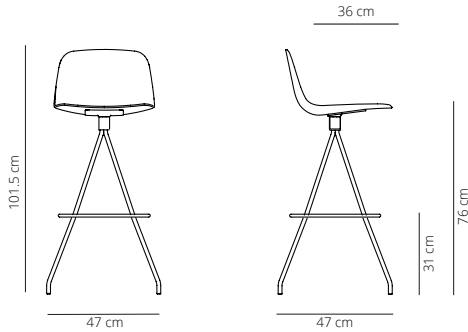

8.8 kg
(x1) 54x54x108 cm (0.31 m³)

CODE	FINISHES		PUBLIC PRICE
	STRUCTURE	SEAT	
MAAPLBARB	white, black	white, black, taupe, dusty green, yellow ochre or brick	2.542 DKK

Smooth upholstered low backrest

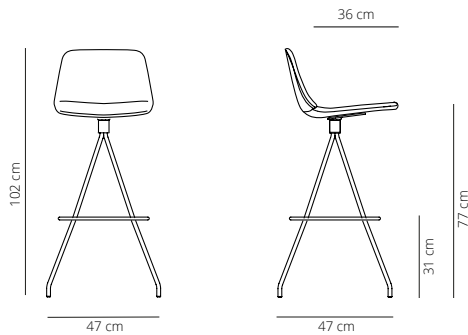

9.2 kg
(x1) 54x54x108 cm (0.31 m³)

CODE	FINISHES		PUBLIC PRICE
	STRUCTURE	UPHOLSTERY	
MAALTBARB-1	white, black	G1 (T/C)	3.898 DKK
MAALTBARB-2		G2	4.051 DKK
MAALTBARB-3		G3	4.314 DKK
MAALTBARB-4		G4	4.678 DKK
MAALTBARB-5		G5	4.983 DKK

Soft upholstered low backrest

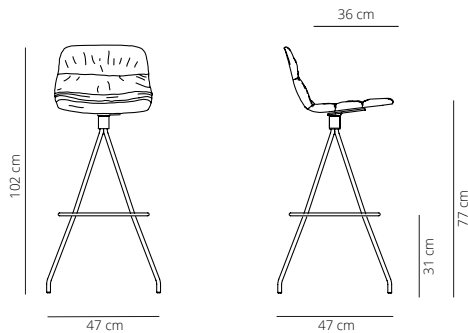

9.4kg
(x1) 54x54x108 cm (0.31 m³)

CODE	FINISHES		PUBLIC PRICE
	STRUCTURE	UPHOLSTERY	
MAATBARB-1	white, black	G1 (T/C)	4.051 DKK
MAATBARB-2		G2	4.204 DKK
MAATBARB-3		G3	4.526 DKK
MAATBARB-4		G4	4.822 DKK
MAATBARB-5		G5	5.144 DKK

+ 4€ 

*Felt glides available with an upcharge of 4€. If not indicated, the chair will be produced with plastic glides.

CHAIRS AND STOOLS

Test certificates: ANSI BIFMA X5.4-2020 and UNE EN 16139:2013vc2015

Four solid oak wood legs stained with the finishes for our collection. Calibrated steel footrest powder coated in black thermoreinforced polyester. Plastic glides with or without felt.*

Needed fabric for material:
1.40 m wide:
Smooth upholstery: 1 m
Soft upholstery: 1 m

FOUR WOODEN LEGS COUNTER STOOL BASE

Plastic low backrest

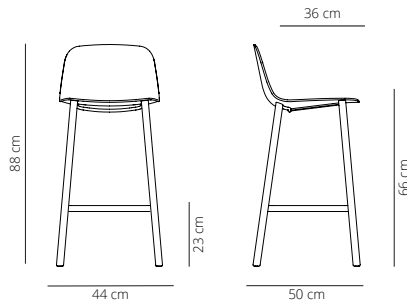

📦 8.6 kg
📦 (x1) 58x56x99 cm (0.32 m³)

Smooth upholstered low backrest

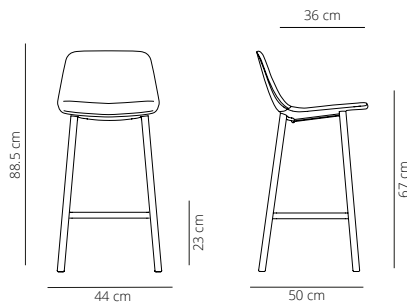

📦 9.0 kg
📦 (x1) 58x56x99 cm (0.32 m³)

Soft upholstered low backrest

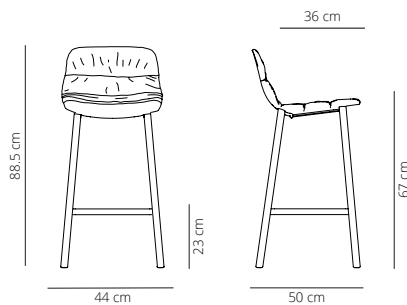

📦 9.2 kg
📦 (x1) 58x56x99 cm (0.32 m³)

CODE	FINISHES		PUBLIC PRICE
	STRUCTURE	SEAT	
MAAPLT4MCOB	matt oak, cognac, ash, bleached oak or walnut	white, black, taupe, dusty green, yellow ochre or brick	3.576 DKK

CODE	FINISHES		PUBLIC PRICE
	STRUCTURE	UPHOLSTERY	
MAALT4MCOB-1	matt oak, cognac, ash, bleached oak or walnut	G1 (T/C)	4.932 DKK
MAALT4MCOB-2		G2	5.085 DKK
MAALT4MCOB-3		G3	5.399 DKK
MAALT4MCOB-4		G4	5.653 DKK
MAALT4MCOB-5		G5	5.924 DKK

CODE	FINISHES		PUBLIC PRICE
	STRUCTURE	UPHOLSTERY	
MAAT4MCOB-1	matt oak, cognac, ash, bleached oak or walnut	G1 (T/C)	5.085 DKK
MAAT4MCOB-2		G2	5.297 DKK
MAAT4MCOB-3		G3	5.602 DKK
MAAT4MCOB-4		G4	5.856 DKK
MAAT4MCOB-5		G5	6.178 DKK

+ 4€  *Felt glides available with an upcharge of 4€. If not indicated, the chair will be produced with plastic glides.

Maarten Chair

2012, BY VICTOR CARRASCO

CHAIRS AND STOOLS

Test certificates: ANSI BIFMA X5.4-2020 and UNE EN 16139:2013vc2015

Four solid oak wood legs stained with the finishes for our collection. Calibrated steel footrest powder coated in black thermoreinforced polyester. Plastic glides with or without felt.*

Needed fabric for material:

1.40 m wide:

Smooth upholstery: 1 m

Soft upholstery: 1 m

FOUR WOODEN LEGS BAR STOOL BASE

Plastic low backrest

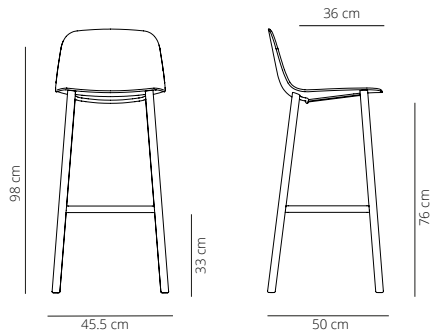

📦 9.0 kg

📦 (x1) 58x56x108 cm (0.35 m³)

CODE	FINISHES		PUBLIC PRICE
	STRUCTURE	SEAT	
MAAPLT4MBARB	matt oak, cognac, ash, bleached oak or walnut	white, black, taupe, dusty green, yellow ochre or brick	3.576 DKK

Smooth upholstered low backrest

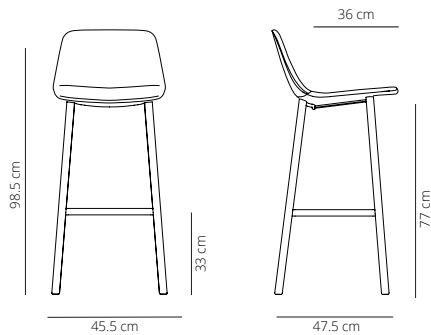

📦 9.4 kg

📦 (x1) 58x56x108 cm (0.35 m³)

CODE	FINISHES		PUBLIC PRICE
	STRUCTURE	UPHOLSTERY	
MAALT4MBARB-1	matt oak, cognac, ash, bleached oak or walnut	G1 (T/C)	4.932 DKK
MAALT4MBARB-2		G2	5.085 DKK
MAALT4MBARB-3		G3	5.399 DKK
MAALT4MBARB-4		G4	5.653 DKK
MAALT4MBARB-5		G5	5.924 DKK

Soft upholstered low backrest

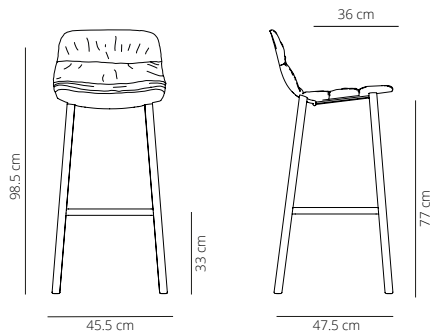

📦 9.6 kg

📦 (x1) 58x56x108 cm (0.35 m³)

CODE	FINISHES		PUBLIC PRICE
	STRUCTURE	UPHOLSTERY	
MAAT4MBARB-1	matt oak, cognac, ash, bleached oak or walnut	G1 (T/C)	5.085 DKK
MAAT4MBARB-2		G2	5.297 DKK
MAAT4MBARB-3		G3	5.602 DKK
MAAT4MBARB-4		G4	5.856 DKK
MAAT4MBARB-5		G5	6.178 DKK



*Felt glides available with an upcharge of 4€. If not indicated, the chair will be produced with plastic glides.

Test certificates: ANSI BIFMA X5.4-2020 and UNE EN 16139:2013vc2015

Needed fabric for material:

1.40 m wide:

Cushion: 0.7 m

Calibrated steel swivel structure powder coated in thermoreinforced polyester in white, black, taupe or fluorescent orange. Black or white plastic glides with or without felt.*

SWIVEL COUNTER STOOL BASE

Plastic high backrest

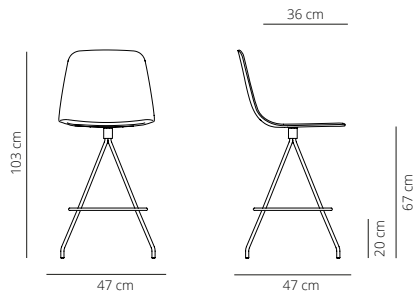

👤 9.7 kg

📦 (x1) 57.5x53.5x110 cm (0.33 m³)

CODE	FINISHES		PUBLIC PRICE
	STRUCTURE	SEAT	
MAAPLCO	white, black	white, black, taupe, dusty green, yellow ochre or brick	2.814 DKK
	taupe	white, black, taupe, dusty green, yellow ochre or brick	3.475 DKK

Plastic high backrest with cushion

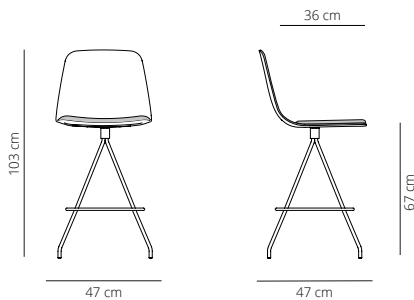

👤 10 kg

📦 (x1) 57.5x53.5x110 cm (0.33 m³)

CODE	FINISHES			PUBLIC PRICE
	STRUCTURE	SEAT	UPHOLSTERY	
MAAPLCO-1	white, black	white, black, taupe, dusty green, yellow ochre or brick	G1 (T/C)	3.475 DKK
MAAPLCO-2			G2	3.576 DKK
MAAPLCO-3			G3	3.737 DKK
MAAPLCO-4			G4	3.941 DKK
MAAPLCO-5			G5	4.153 DKK
MAAPLCO-1	taupe	white, black, taupe, dusty green, yellow ochre or brick	G1 (T/C)	3.576 DKK
MAAPLCO-2			G2	4.153 DKK
MAAPLCO-3			G3	4.254 DKK
MAAPLCO-4			G4	4.415 DKK
MAAPLCO-5			G5	4.678 DKK

+ 4€ 

*Felt glides available with an upcharge of 4€. If not indicated, the chair will be produced with plastic glides.

Needed fabric for material:
1.40 m wide:
Smooth upholstery: 1.1 m
Soft upholstery: 1.1 m

Smooth upholstered high backrest

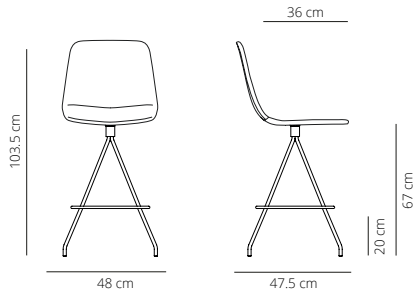

10 kg
(x1) 57.5x53.5x110 cm (0.33 m³)

CODE	FINISHES		PUBLIC PRICE
	STRUCTURE	UPHOLSTERY	
MAALTCO-1	white, black	G1 (T/C)	4.932 DKK
MAALTCO-2		G2	5.399 DKK
MAALTCO-3		G3	5.924 DKK
MAALTCO-4		G4	6.543 DKK
MAALTCO-5		G5	7.170 DKK
MAALTCO-1	taupe	G1 (T/C)	6.433 DKK
MAALTCO-2		G2	6.899 DKK
MAALTCO-3		G3	7.424 DKK
MAALTCO-4		G4	8.043 DKK
MAALTCO-5		G5	8.670 DKK

Soft upholstered high backrest

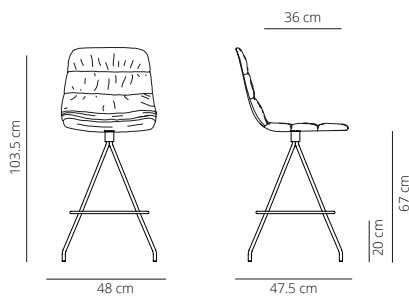

10.3 kg
(x1) 57.5x53.5x110cm (0.33 m³)

CODE	FINISHES		PUBLIC PRICE
	STRUCTURE	UPHOLSTERY	
MAATCO-1	white, black	G1 (T/C)	5.297 DKK
MAATCO-2		G2	5.763 DKK
MAATCO-3		G3	6.331 DKK
MAATCO-4		G4	6.899 DKK
MAATCO-5		G5	7.526 DKK
MAATCO-1	taupe	G1 (T/C)	6.797 DKK
MAATCO-2		G2	7.272 DKK
MAATCO-3		G3	7.789 DKK
MAATCO-4		G4	8.416 DKK
MAATCO-5		G5	9.034 DKK



+ 4€

*Felt glides available with an upcharge of 4€. If not indicated, the chair will be produced with plastic glides.

Test certificates: ANSI BIFMA X5.4-2020 and UNE EN 16139:2013vc2015

Calibrated steel swivel structure powder coated in thermoreinforced polyester in white, black, taupe or fluorescent orange. Black or white plastic glides with or without felt.*

Needed fabric for material:

1.40 m wide:

Cushion: 0.7 m

SWIVEL BAR STOOL BASE

Plastic high backrest

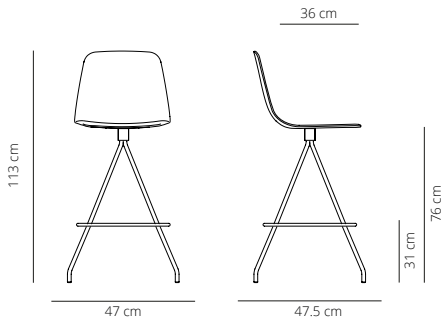

11.1 kg

(x1) 57.5x53.5x120 cm (0.37 m³)

CODE	FINISHES		PUBLIC PRICE
	STRUCTURE	SEAT	
MAAPLBAR	white, black	white, black, taupe, dusty green, yellow ochre or brick	2.814 DKK
	taupe	white, black, taupe, dusty green, yellow ochre or brick	3.475 DKK

Plastic high backrest with cushion

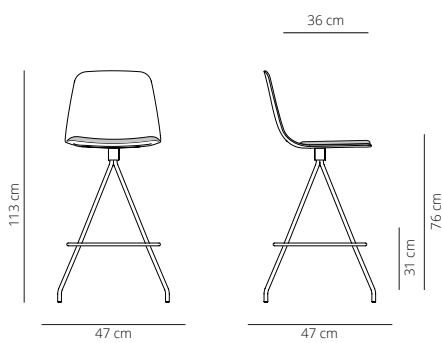

11.4 kg

(x1) 57.5x53.5x120 cm (0.37 m³)

CODE	FINISHES			PUBLIC PRICE
	STRUCTURE	SEAT	UPHOLSTERY	
MAAPLBARC-1	white, black	white, black, taupe, dusty green, yellow ochre or brick	G1 (T/C)	3.475 DKK
MAAPLBARC-2			G2	3.576 DKK
MAAPLBARC-3			G3	3.737 DKK
MAAPLBARC-4			G4	3.941 DKK
MAAPLBARC-5			G5	4.153 DKK
MAAPLBARC-1	taupe	white, black, taupe, dusty green, yellow ochre or brick	G1 (T/C)	3.576 DKK
MAAPLBARC-2			G2	4.153 DKK
MAAPLBARC-3			G3	4.254 DKK
MAAPLBARC-4			G4	4.415 DKK
MAAPLBARC-5			G5	4.678 DKK

+ 4€ 

*Felt glides available with an upcharge of 4€. If not indicated, the chair will be produced with plastic glides.

Maarten Chair

2012, BY VICTOR CARRASCO

CHAIRS AND STOOLS

Needed fabric for material:
1.40 m wide:
Smooth upholstery: 1.1 m
Soft upholstery: 1.1 m

Smooth upholstered high backrest

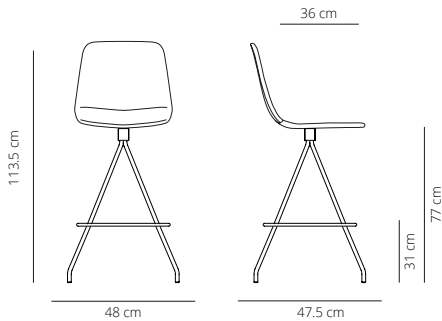

11.4 kg

(x1) 57.5x53.5x120 cm (0.37 m³)

CODE	FINISHES		PUBLIC PRICE
	STRUCTURE	UPHOLSTERY	
MAALTBAR-1	white, black	G1 (T/C)	4.932 DKK
MAALTBAR-2		G2	5.399 DKK
MAALTBAR-3		G3	5.924 DKK
MAALTBAR-4		G4	6.543 DKK
MAALTBAR-5		G5	7.170 DKK
MAALTBAR-1	taupe	G1 (T/C)	6.433 DKK
MAALTBAR-2		G2	6.899 DKK
MAALTBAR-3		G3	7.424 DKK
MAALTBAR-4		G4	8.043 DKK
MAALTBAR-5		G5	8.670 DKK

Soft upholstered high backrest

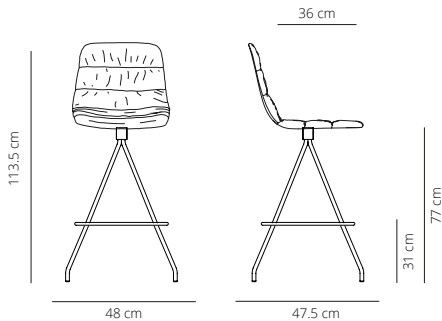

11.7 kg

(x1) 57.5x53.5x120 cm (0.37 m³)

CODE	FINISHES		PUBLIC PRICE
	STRUCTURE	UPHOLSTERY	
MAATBAR-1	white, black	G1 (T/C)	5.297 DKK
MAATBAR-2		G2	5.763 DKK
MAATBAR-3		G3	6.331 DKK
MAATBAR-4		G4	6.899 DKK
MAATBAR-5		G5	7.526 DKK
MAATBAR-1	taupe	G1 (T/C)	6.797 DKK
MAATBAR-2		G2	7.272 DKK
MAATBAR-3		G3	7.789 DKK
MAATBAR-4		G4	8.416 DKK
MAATBAR-5		G5	9.034 DKK



+ 4€

*Felt glides available with an upcharge of 4€. If not indicated, the chair will be produced with plastic glides.

AUDITORIUM BASE

Plastic

Injected polypropylene seat in white, black, taupe, dusty green, yellow ochre or brick.
Screws or anchoring system not included.

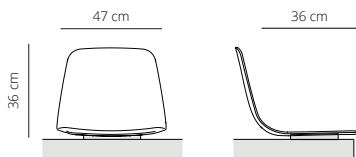

📏 12.7 kg

📦 (x1) 53x53x53 cm (0.15 m³)*

CODE	FINISHES		PUBLIC PRICE
	STRUCTURE	SEAT	
MAAPLAU	grey	white, black, taupe, dusty green, yellow ochre or brick	1.356 DKK

NOTE: Price per unit. The package contain 2 units.

Plastic with cushion

Injected polypropylene seat in white, black, taupe, dusty green, yellow ochre or brick and seat cushion. Screws or anchoring system not included.

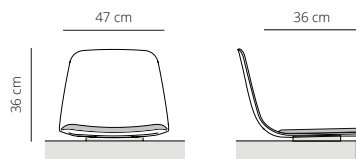

📏 12.7 kg

📦 (x1) 53x53x53 cm (0.15 m³)*

CODE	FINISHES			PUBLIC PRICE
	STRUCTURE	SEAT	UPHOLSTERY	
MAAPLAUC-1	grey	white, black, taupe, dusty green, yellow ochre or brick	G1 (T/C)	2.026 DKK
MAAPLAUC-2			G2	2.127 DKK
MAAPLAUC-3			G3	2.280 DKK
MAAPLAUC-4			G4	2.492 DKK
MAAPLAUC-5			G5	2.746 DKK

NOTE: Price per unit. The package contain 2 units.

Maarten Chair

2012, BY VICTOR CARRASCO

CHAIRS AND STOOLS

Smooth upholstery

Injected polypropylene seat in smooth upholstery. Screws or anchoring system not included.

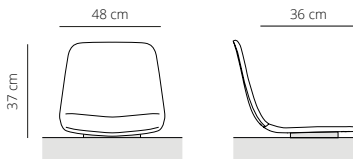

📦 13.3 kg

📦 (x1) 53x53x53 cm (0.15 m³)*

CODE	FINISHES		PUBLIC PRICE
	STRUCTURE	UPHOLSTERY	
MAALAU-1	grey	G1 (T/C)	2.390 DKK
MAALAU-2		G2	2.746 DKK
MAALAU-3		G3	3.110 DKK
MAALAU-4		G4	3.534 DKK
MAALAU-5		G5	3.992 DKK

NOTE: Price per unit. The package contain 2 units.

Soft upholstery

Injected polypropylene seat in soft upholstery. Screws or anchoring system not included.

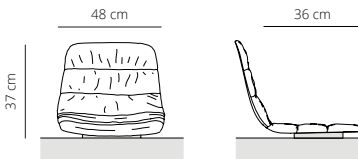

📦 13.3 kg

📦 (x1) 53x53x53m (0.15 m³)

CODE	FINISHES		PUBLIC PRICE
	STRUCTURE	UPHOLSTERY	
MAAAU-1	grey	G1 (T/C)	2.814 DKK
MAAAU-2		G2	3.110 DKK
MAAAU-3		G3	3.475 DKK
MAAAU-4		G4	3.898 DKK
MAAAU-5		G5	4.356 DKK

NOTE: Price per unit. The package contain 2 units.

Metal armrest

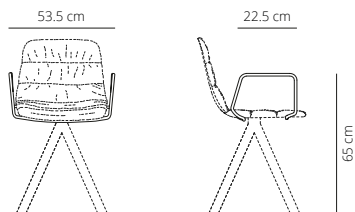

👤 1.1 kg

📦 Included and fitted on the chair

CODE	FINISHES		PUBLIC PRICE
	STRUCTURE		
MABR	white, black, taupe or orange fluor		780 DKK

Calibrated steel armrest powder coated in thermoreinforced polyester in black, white, taupe or fluorescent orange. Available for high backrests.

Wooden armrest

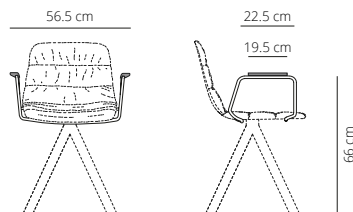

👤 1.4 kg

📦 Included and fitted on the chair

CODE	FINISHES		PUBLIC PRICE
	STRUCTURE	STAIN	
MAABRM	white, black, taupe or orange fluor	matt oak, cognac, ash, bleached oak or walnut	1.653 DKK

Calibrated steel armrest powder coated in thermoreinforced polyester in black, white, taupe or fluorescent orange, with natural oak armrests stained with the finishes of our collection. Available for high backrests.

NOTE: Due to the fact that the wood used is natural, the finish may vary.

Upholstered armrest

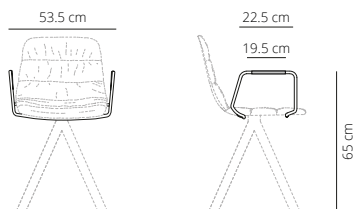

👤 1.1 kg

📦 Included and fitted on the chair

CODE	FINISHES		PUBLIC PRICE
	STRUCTURE	UPHOLSTERY	
MAABRTP	white, black, taupe or orange fluor	ecoleather	1.246 DKK
MAABRTL		leather	1.246 DKK

Calibrated steel armrest powder coated in thermoreinforced polyester in black, white, taupe or fluorescent orange and upholstered with leather or ecoleather. Available for high backrests.

ACCESSORIES

Linking device **NEW**

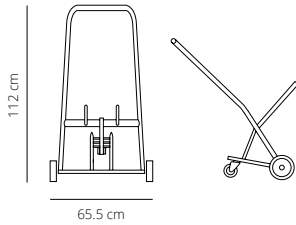

8.2 kg
(x1) 69.5x89x89 cm (0.55m³)

x10 The transport is possible for a maximum of 10 chairs simultaneously.

CODE	FINISHES	PUBLIC PRICE
MAACT	black	3.737 DKK

Available to transport stackable chairs. Trolley lacquered in black.

Writing tablet

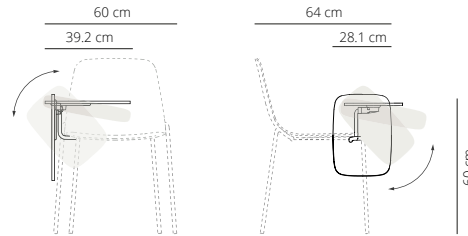

2.3 kg
Included and fitted on the chair

CODE	SILLA	FINISHES		PUBLIC PRICE
		STRUCTURE	WRITING TABLET	
MAAL4P-PALAD	four metal legs base	white, black, taupe or fluorescent orange	black	881 DKK
MAAL4P-PALAI				881 DKK
MAALPT-PALAD	sled base			881 DKK
MAALPT-PALAI				881 DKK

HPL tablet with aluminum mechanism and anti-panic system. Left or right handed versions. Available only for four metal legs base.

NOTE: Structures of the side table and the chair are always in the same color.

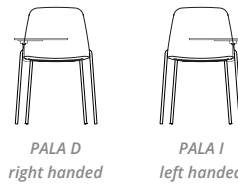

IMPORTANT INFORMATION:
The writing tablet has options for right and left handed people.
Take in count the code for each version when making the order.

Linking device

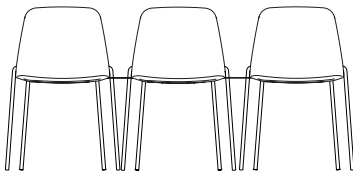

CODE	FINISHES	PUBLIC PRICE
MAAUN	black	322 DKK

Note: Price for two units
Joining system for chairs with four-leg base.
Black finish.



Season Chair

BY PIERO LISSONI

Test certificates: ANSI BIFMA X5.4:2012 y UNE EN 16139:13 vc2015 (only without casters). ANSI BIFMA x5.1:2011 (only with casters)

1- Interior structure in solid wood and perforated top of microparticles low in formaldehyde. For the production of this pieces Viccarbe is using wood from certified sustainable forestry sources.

2- Expanded polyurethane foam in different densities.

3- Fabric or leather.

4- Upholstery protection (technical fabric*)

5- Hidden casters or legs with height adjustment.

*Check all the technical fabric colours available on [page 20](#).

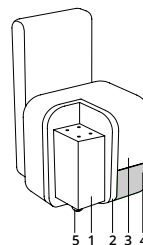

reddot award 2016
winner

Needed fabric for material:
1.40 m wide: 2.4 m

Fixed chair

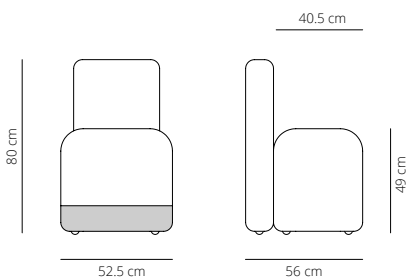

17.8 kg
(x1) 58x54x89cm (0.28 m³)

CODE	FINISHES		PUBLIC PRICE
	UPHOLSTERY PROTECTION	UPHOLSTERY	
SECHF-1	technical fabric, light or dark grey	G1 (COM/COL)	5.034 DKK
SECHF-2		G2	5.763 DKK
SECHF-3		G3	7.272 DKK
SECHF-4		G4	9.136 DKK
SECHF-5		G5	10.704 DKK

Chair with casters

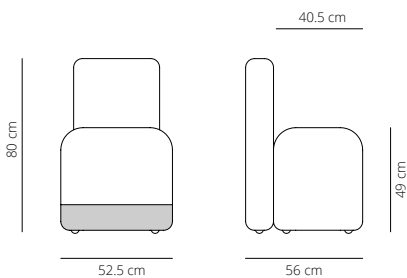

18.2 kg
(x1) 58x54x89cm (0.28 m³)

CODE	FINISHES		PUBLIC PRICE
	UPHOLSTERY PROTECTION	UPHOLSTERY	
SECH-1	technical fabric, light or dark grey	G1 (COM/COL)	5.238 DKK
SECH-2		G2	5.966 DKK
SECH-3		G3	7.424 DKK
SECH-4		G4	9.348 DKK
SECH-5		G5	10.899 DKK



Klip

BY VICTOR CARRASCO

CHAIRS AND STOOLS

A plywood oak chair with the finishes from our collection. Optional cushion upholstered in fabric or leather. Perfect for home and contract use, stackable up to 10 chairs for the non upholstered version and 4 chairs for the upholstered version.

Its name is a reference to the slot in its back, which serves both as a handle for moving it about easily and as a hang for handbags etc.

We do not recommend stacking upholstered chairs for long periods of time as it can damage the upholstery.

[For the production of this sofa Viccarbe is using wood from certified sustainable forestry sources]

SEAT OPTIONS

Stained / Lacquered with handle

Curved oak plywood stained or curved beech plywood lacquered in the finishes of our collection, with the handle in the back. Maximum weight supported by the handle: 33.1 lb.

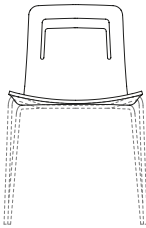

Stained / Lacquered with handle

Curved oak plywood stained or curved beech plywood lacquered in the finishes of our collection, without handle in the back.

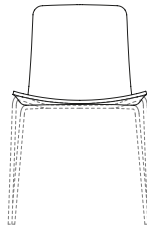

Smooth upholstery

Plywood natural beech chair covered by expanded polyurethane foam, smooth upholstery.

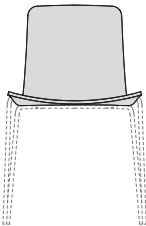

Soft upholstery

Plywood natural beech chair covered by expanded polyurethane foam, soft upholstery.

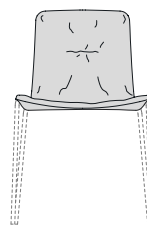

Lined upholstery

Plywood natural beech chair covered by expanded polyurethane foam, lined upholstery.

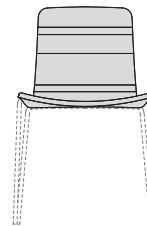

Stained / Lacquered with cushion and handle

Curved oak plywood stained or curved beech lacquered plywood lacquered in the finishes of our collection, with upholstered cushion and the handle in the back. Maximum weight supported by the handle: 33.1lb.

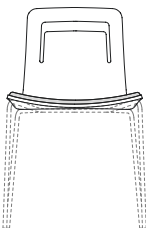

Stained / Lacquered with cushion and without handle

Curved oak plywood stained or curved beech plywood lacquered in the finishes of our collection, with upholstered cushion and without the handle in the back.

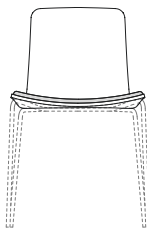

CHAIR BASE OPTIONS

Four metal legs

Calibrated steel structure powder coated in thermoreinforced polyester in white, black, taupe or fluorescent orange. Black or white plastic glides with or without felt.

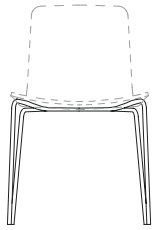

Swivel

Calibrated steel swivel structure powder coated in thermoreinforced polyester in white, black, taupe or fluorescent orange. Black or white plastic glides with or without felt.

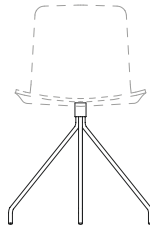

Pyramid swivel

Injected swivel aluminium base powder coated in thermoreinforced polyester in black or white microtexturized. Black or translucent plastic glides, with or without felt.

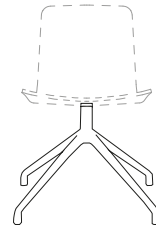

Pyramid swivel with casters

Injected swivel aluminium base powder coated in thermoreinforced polyester in black or white microtexturized with black or white soft casters for hard floors.

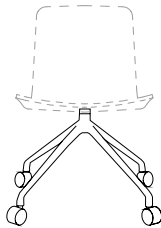

Five casters

Aluminum swivel base powder coated in black or white (high gloss), height adjustment system and black or white soft casters for hard floors.*

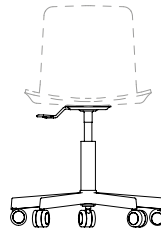

*6 weeks production time.

Flat swivel

Injected swivel aluminium base powder coated in thermoreinforced polyester in black or white microtexturized. Black or translucent plastic glides, with or without felt.

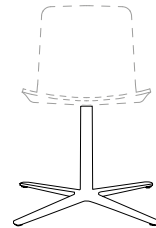

STOOL BASE OPTIONS

Swivel counter stool

Calibrated steel swivel structure powder coated in thermoreinforced polyester in white, black, taupe or fluorescent orange. Black or white plastic glides wit or without felt.

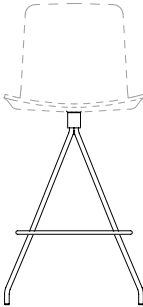

Swivel bar stool

Calibrated steel swivel structure powder coated in thermoreinforced polyester in white, black, taupe or fluorescent orange. Black or white plastic glides wit or without felt.

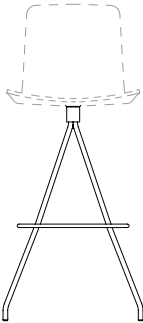

Fixed counter stool

Calibrated steel structure powder coated in thermoreinforced polyester in white, black, taupe or fluorescent orange. Black or white plastic glides wit or without felt.

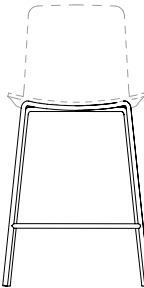

Fixed bar stool

Calibrated steel structure powder coated in thermoreinforced polyester in white, black, taupe or fluorescent orange. Black or white plastic glides wit or without felt.

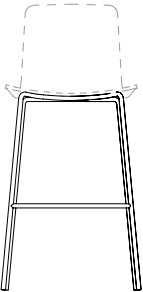

ARMREST OPTIONS

Armrest

Calibrated steel armrest powder coated in thermoreinforced polyester in black, white, taupe or fluorescent orange.

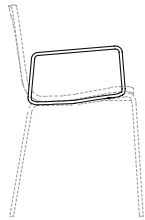

Upholstered armrest

Calibrated steel armrest powder coated in thermoreinforced polyester in black, white, taupe or fluorescent orange and upholstered with leather or ecoleather armrest.

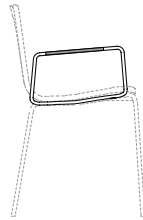

ACCESSORIES

Side table

HPL sidetable with aluminum mechanism and anti-panic system. Left or right versions. Available only for four metal legs base.

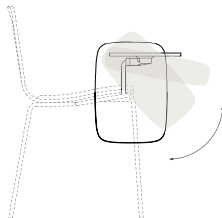

CHAIRS AND STOOLS

Test certificates: ANSI BIFMA x5.1:2011 and UNE EN 16139:13 (for every seat finishing, with or without armrest)

Calibrated steel structure powder coated in thermoreinforced polyester in white, black, taupe or fluorescent orange.
Black or white plastic glides with or without felt.**

No more than 10 units of the four leg base and no more than 4 units of the four legs base with upholstered finishes should be stacked up.

**The whole range of colors has a smooth lacquered finish except black, which has a lacquered microtextured finish.*

NOTE: Due to the fact that the wood used is natural, the finish may vary.

NOTE: We don't recommend to stack up upholstered chairs for a long period of time because it can damage the upholstery. We recommend using the stacking protector pad for stacking upholstered chairs. (See page 175)

FOUR METAL LEGS BASE

Stained / Lacquered with handle

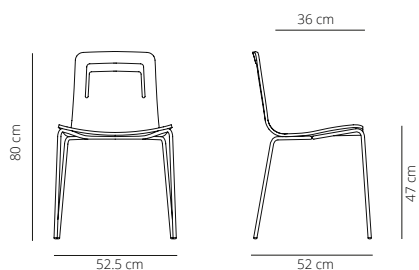

14 kg
(x1) 55x92x58cm (0.3m³)

x10 Stackable up to 10 units.

CODE	FINISHES		PUBLIC PRICE
	STRUCTURE	SEAT	
KL4PROR	white, black, taupe or fluorescent orange	stained	matt oak, cognac, ash, bleached oak or walnut 2.026 DKK
KL4PTXR		lacquered	white or black*
	taupe, brick, ochre, olive green, dusty pink or dusty green		2.390 DKK
	bronze		2.542 DKK

NOTE: Price per unit.

Stained / Lacquered without handle

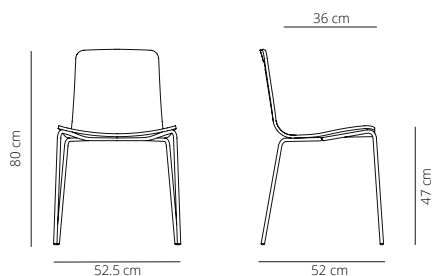

14 kg
(x1) 55x92x58cm (0.3m³)

x10 Stackable up to 10 units. The package contains 2 units.

CODE	FINISHES		PUBLIC PRICE
	STRUCTURE	SEAT	
KL4PRO	white, black, taupe or fluorescent orange	stained	matt oak, cognac, ash, bleached oak or walnut 2.026 DKK
KL4PTX		lacquered	white or black*
	taupe, brick, ochre, olive green, dusty pink or dusty green		2.390 DKK
	bronze		2.542 DKK

NOTE: Price per unit.

Metal or upholstered metal armrests can be added. Accessories available.
More information on page 183

+ 4€  **Felt glides available with an upcharge of 4€. If not indicated, the chair will be produced with plastic glides.

Needed fabric for material: 1.40 m wide:
Smooth upholstery: 1 m
Soft upholstery: 1 m
Lined upholstery: 1 m

Smooth upholstery

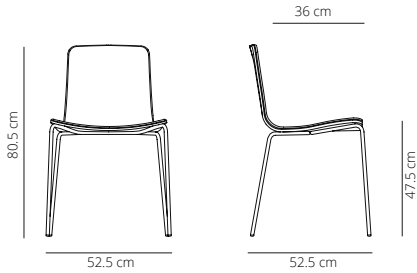

9.2 kg
 (x1) 58x55x88cm (0.3m³)

x4 Stackable up to 4 units

CODE	FINISHES		PUBLIC PRICE
	STRUCTURE	UPHOLSTERY	
KL4PT-1	white, black, taupe or fluorescent orange	G1(COM/COL)	2.492 DKK
KL4PT-2		G2	2.814 DKK
KL4PT-3		G3	3.068 DKK
KL4PT-4		G4	3.365 DKK
KL4PT-5		G5	3.687 DKK

Soft upholstery

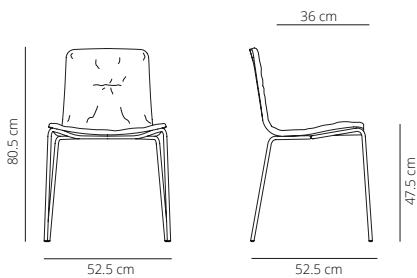

9.7 kg
 (x1) 58x55x88cm (0.3m³)

x4 Stackable up to 4 units

CODE	FINISHES		PUBLIC PRICE
	STRUCTURE	UPHOLSTERY	
KL4PTS-1	white, black, taupe or fluorescent orange	G1(COM/COL)	2.856 DKK
KL4PTS-2		G2	3.110 DKK
KL4PTS-3		G3	3.365 DKK
KL4PTS-4		G4	3.687 DKK
KL4PTS-5		G5	3.992 DKK

Lined upholstery

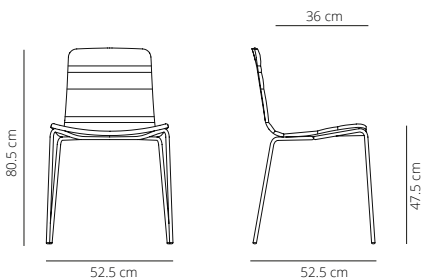

9.7 kg
 (x1) 58x55x88cm (0.3m³)

x4 Stackable up to 4 units

CODE	FINISHES		PUBLIC PRICE
	STRUCTURE	UPHOLSTERY	
KL4PB-1	white, black, taupe or fluorescent orange	G1(COM/COL)	2.856 DKK
KL4PB-2		G2	3.110 DKK
KL4PB-3		G3	3.365 DKK
KL4PB-4		G4	3.687 DKK
KL4PB-5		G5	3.992 DKK

Metal or upholstered metal armrests can be added. Accessories available.
 More information on page 183

+ 4€  **Felt glides available with an upcharge of 4€. If not indicated, the chair will be produced with plastic glides.

Needed fabric for material:
1.40 m wide: 0.7 m

CHAIRS AND STOOLS

Stained/ Lacquered with handle and cushion

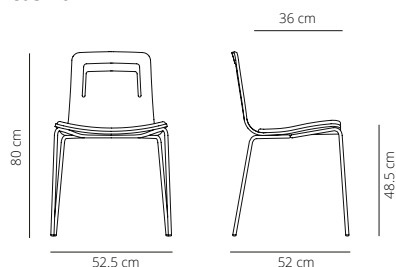

10.2 kg
(x1) 58x55x88cm (0.3m³)

x4 Stackable up to 4 units

CODE	FINISHES			PUBLIC PRICE		
	STRUCTURE	SEAT	UPHOLSTERY			
KL4PROCR-1	white, black, taupe or fluorescent orange	stained	matt oak, cognac, ash, bleached oak or walnut	G1(COM/COL)	3.009 DKK	
KL4PROCR-2				G2	3.322 DKK	
KL4PROCR-3				G3	3.636 DKK	
KL4PROCR-4				G4	3.941 DKK	
KL4PROCR-5				G5	4.254 DKK	
KL4P1CR-1		lacquered	white or black*	G1(COM/COL)	G1	3.220 DKK
KL4P1CR-2					G2	3.534 DKK
KL4P1CR-3					G3	3.848 DKK
KL4P1CR-4					G4	4.153 DKK
KL4P1CR-5					G5	4.526 DKK
KL4P2CR-1			taupe, brick, ochre, olive green, dusty pink or dusty green	G1(COM/COL)	G1	3.365 DKK
KL4P2CR-2					G2	3.687 DKK
KL4P2CR-3					G3	3.992 DKK
KL4P2CR-4					G4	4.314 DKK
KL4P2CR-5					G5	4.678 DKK
KL4P3CR-1		bronze	G1(COM/COL)	G1	3.534 DKK	
KL4P3CR-2				G2	3.848 DKK	
KL4P3CR-3				G3	4.153 DKK	
KL4P3CR-4				G4	4.526 DKK	
KL4P3CR-5				G5	4.822 DKK	

Metal or upholstered metal armrests can be added. Accessories available.
More information on page 183

+ 4€  **Felt glides available with an upcharge of 4€. If not indicated, the chair will be produced with plastic glides.

Needed fabric for material:
1.40 m wide: 0.7 m

Stained/ Lacquered without handle and with cushion

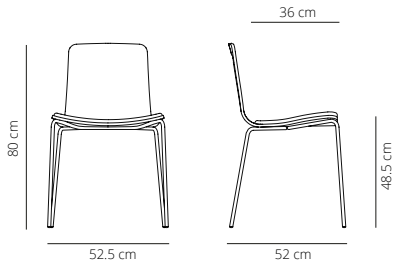

10.2 kg
(x1) 58x55x88cm (0.3m³)

x4 Stackable up to 4 units

CODE	FINISHES			PUBLIC PRICE	
	STRUCTURE	SEAT	UPHOLSTERY		
KL4PROC-1	white, black, taupe or fluorescent orange	stained	G1(COM/COL)	3.009 DKK	
KL4PROC-2			G2	3.322 DKK	
KL4PROC-3			G3	3.636 DKK	
KL4PROC-4			G4	3.941 DKK	
KL4PROC-5			G5	4.254 DKK	
KL4P1C-1		lacquered	white or black*	G1(COM/COL)	3.220 DKK
KL4P1C-2				G2	3.534 DKK
KL4P1C-3				G3	3.848 DKK
KL4P1C-4				G4	4.153 DKK
KL4P1C-5				G5	4.526 DKK
KL4P2C-1			taupe, brick, ochre, olive green, dusty pink or dusty green	G1(COM/COL)	3.365 DKK
KL4P2C-2				G2	3.687 DKK
KL4P2C-3				G3	3.992 DKK
KL4P2C-4				G4	4.314 DKK
KL4P2C-5				G5	4.678 DKK
KL4P3C-1			bronze	G1(COM/COL)	3.534 DKK
KL4P3C-2				G2	3.848 DKK
KL4P3C-3				G3	4.153 DKK
KL4P3C-4				G4	4.526 DKK
KL4P3C-5				G5	4.822 DKK

Metal or upholstered metal armrests can be added. Accessories available.
More information on page 183

+ 4€  **Felt glides available with an upcharge of 4€. If not indicated, the chair will be produced with plastic glides.

CHAIRS AND STOOLS

Test certificates: ANSI BIFMA x5.1:2011 (for every seat finishing, with or without armrest)

Calibrated steel swivel structure powder coated in thermoreinforced polyester in white, black, taupe or fluorescent orange. Black or white plastic glides with or without felt.*

**The whole range of colors has a smooth lacquered finish except black, which has a lacquered microtextured finish.*

NOTE: Due to the fact that the wood used is natural, the finish may vary.

SWIVEL BASE

Stained / Lacquered with handle

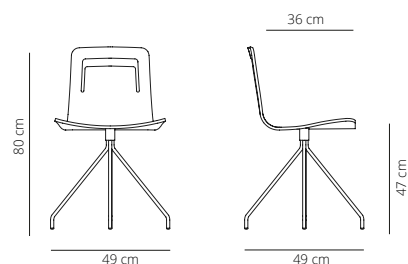

📦 13.6 kg
 📦 (x1) 58x55x88 cm (0.28 m³)

CODE	FINISHES		PUBLIC PRICE	
	STRUCTURE	SEAT		
KLGROR		stained	matt oak, cognac, ash, bleached oak or walnut	2.746 DKK
KLGTXR	white, black or taupe	lacquered	white or black*	2.907 DKK
			taupe, brick, ochre, olive green, dusty pink or dusty green	3.068 DKK
			bronze	3.220 DKK

Stained / Lacquered without handle

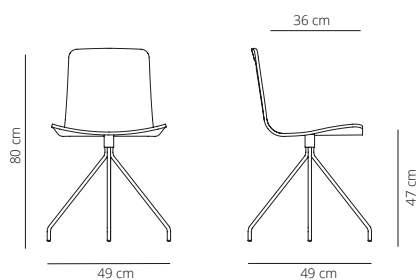

📦 13.6 kg
 📦 (x1) 58x55x88 cm (0.28 m³)

CODE	FINISHES		PUBLIC PRICE	
	STRUCTURE	SEAT		
KLGRO		stained	matt oak, cognac, ash, bleached oak or walnut	2.746 DKK
KLGTX	white, black or taupe	lacquered	white or black*	2.907 DKK
			taupe, brick, ochre, olive green, dusty pink or dusty green	3.068 DKK
			bronze	3.220 DKK

Metal or upholstered metal armrests can be added. Accessories available. More information on page 183

+ 4€  ***Felt glides available with an upcharge of 4€. If not indicated, the chair will be produced with plastic glides.*

Needed fabric for material: 1.40 m wide:
Smooth upholstery: 1 m
Soft upholstery: 1 m
Lined upholstery: 1 m

Smooth upholstery

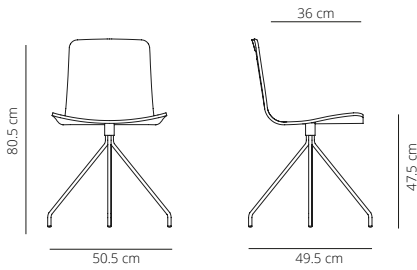

📦 13.6 kg
 📦 (x1) 58x55x88 cm (0.28 m³)

CODE	FINISHES		PUBLIC PRICE
	STRUCTURE	UPHOLSTERY	
KLGT-1	white, black or taupe	G1(COM/COL)	3.220 DKK
KLGT-2		G2	3.475 DKK
KLGT-3		G3	3.737 DKK
KLGT-4		G4	4.051 DKK
KLGT-5		G5	4.356 DKK

Soft upholstery

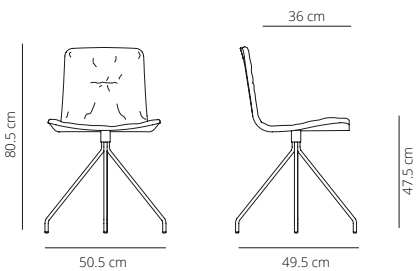

📦 13.6 kg
 📦 (x1) 58x55x88 cm (0.28 m³)

CODE	FINISHES		PUBLIC PRICE
	STRUCTURE	UPHOLSTERY	
KLGTS-1	white, black or taupe	G1(COM/COL)	3.534 DKK
KLGTS-2		G2	3.788 DKK
KLGTS-3		G3	4.051 DKK
KLGTS-4		G4	4.356 DKK
KLGTS-5		G5	4.721 DKK

Lined upholstery

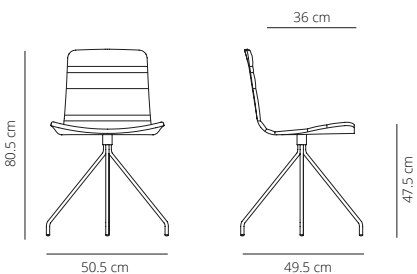

📦 13.6 kg
 📦 (x1) 58x55x88 cm (0.28 m³)

CODE	FINISHES		PUBLIC PRICE
	STRUCTURE	UPHOLSTERY	
KLGB-1	white, black or taupe	G1(COM/COL)	3.534 DKK
KLGB-2		G2	3.788 DKK
KLGB-3		G3	4.051 DKK
KLGB-4		G4	4.356 DKK
KLGB-5		G5	4.721 DKK

*Metal or upholstered metal armrests can be added. Accessories available.
 More information on page 183*

+ 4€  ***Felt glides available with an upcharge of 4€. If not indicated, the chair will be produced with plastic glides.*

Needed fabric for material:
1.40 m wide: 0.7 m

CHAIRS AND STOOLS

Stained/ Lacquered with handle and cushion

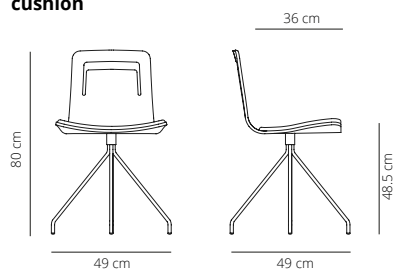

13.6 kg
(x1) 58x55x88 cm (0.28 m³)

CODE	FINISHES			PUBLIC PRICE	
	STRUCTURE	SEAT	UPHOLSTERY		
KLGROCR-1	white, black or taupe	stained	G1(COM/COL)	3.687 DKK	
KLGROCR-2			matt oak, cognac, ash, bleached oak or walnut	G2	3.992 DKK
KLGROCR-3			G3	4.314 DKK	
KLGROCR-4			G4	4.678 DKK	
KLGROCR-5			G5	4.983 DKK	
KLG1CR-1		lacquered	white or black*	G1(COM/COL)	3.848 DKK
KLG1CR-2				G2	4.153 DKK
KLG1CR-3				G3	4.526 DKK
KLG1CR-4				G4	4.822 DKK
KLG1CR-5				G5	5.144 DKK
KLG2CR-1			taupe, brick, ochre, olive green, dusty pink or dusty green	G1(COM/COL)	3.992 DKK
KLG2CR-2				G2	4.314 DKK
KLG2CR-3				G3	4.678 DKK
KLG2CR-4				G4	4.983 DKK
KLG2CR-5				G5	5.297 DKK
KLG3CR-1			bronze	G1(COM/COL)	4.153 DKK
KLG3CR-2				G2	4.526 DKK
KLG3CR-3				G3	4.822 DKK
KLG3CR-4				G4	5.144 DKK
KLG3CR-5				G5	5.449 DKK

Metal or upholstered metal armrests can be added. Accessories available.
More information on page 183

+ 4€  **Felt glides available with an upcharge of 4€. If not indicated, the chair will be produced with plastic glides.

Needed fabric for material:
1.40 m wide: 0.7 m

Stained/ Lacquered without handle and with cushion

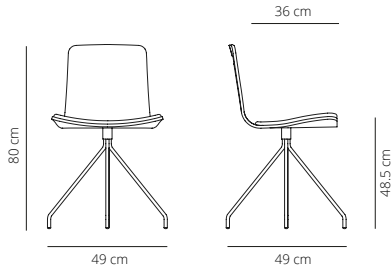

13.6 kg
(x1) 58x55x88 cm (0.28 m³)

CODE	FINISHES			PUBLIC PRICE	
	STRUCTURE	SEAT	UPHOLSTERY		
KLGROC-1	white, black or taupe	stained	G1(COM/COL)	3.687 DKK	
KLGROC-2			G2	3.992 DKK	
KLGROC-3			G3	4.314 DKK	
KLGROC-4			G4	4.678 DKK	
KLGROC-5			G5	4.983 DKK	
KLG1C-1		lacquered	white or black*	G1(COM/COL)	3.848 DKK
KLG1C-2				G2	4.153 DKK
KLG1C-3				G3	4.526 DKK
KLG1C-4				G4	4.822 DKK
KLG1C-5				G5	5.144 DKK
KLG2C-1			taupe, brick, ochre, olive green, dusty pink or dusty green	G1(COM/COL)	3.992 DKK
KLG2C-2				G2	4.314 DKK
KLG2C-3				G3	4.678 DKK
KLG2C-4				G4	4.983 DKK
KLG2C-5				G5	5.297 DKK
KLG3C-1			bronze	G1(COM/COL)	4.153 DKK
KLG3C-2				G2	4.526 DKK
KLG3C-3				G3	4.822 DKK
KLG3C-4				G4	5.144 DKK
KLG3C-5				G5	5.449 DKK

Metal or upholstered metal armrests can be added. Accessories available.
More information on page 183

+ 4€  **Felt glides available with an upcharge of 4€. If not indicated, the chair will be produced with plastic glides.

CHAIRS AND STOOLS

Test certificates: ANSI BIFMA X5.4:2012 and UNE-EN 16139:2013vc2015

(for every seat finishing, with or without armrest)

Injected aluminum swivel base powder coated in thermoreinforced polyester in black or white microtexturized.

Black or white plastic glides with or without felt.*

**The whole range of colours has a smooth lacquered finish except black, which has a lacquered microtextured finish.*

NOTE: Due to the fact that the wood used is natural, the finish may vary.

PYRAMID SWIVEL BASE

Stained / Lacquered with handle

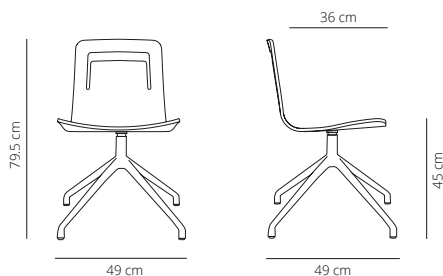

📦 12.6 kg
📦 (x1) 58x55x88 cm (0.28 m³)

CODE	FINISHES		PUBLIC PRICE	
	STRUCTURE	SEAT		
KLPIROR		stained	matt oak, cognac, ash, bleached oak or walnut	3.068 DKK
KLPIXR	white, black (microtexturized)	lacquered	white or black*	3.220 DKK
			taupe, brick, ochre, olive green, dusty pink or dusty green	3.365 DKK
			bronze	3.534 DKK

Stained / Lacquered without handle

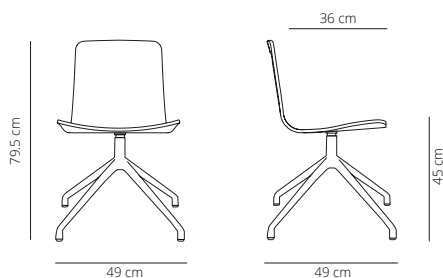

📦 12.6 kg
📦 (x1) 58x55x88 cm (0.28 m³)

CODE	FINISHES		PUBLIC PRICE	
	STRUCTURE	SEAT		
KLPIRO		stained	matt oak, cognac, ash, bleached oak or walnut	3.068 DKK
KLPIRX	white, black (microtexturized)	lacquered	white or black*	3.220 DKK
			taupe, brick, ochre, olive green, dusty pink or dusty green	3.365 DKK
			bronze	3.534 DKK

Metal or upholstered metal armrests can be added. Accessories available. More information on page 183

+ 4€  ***Felt glides available with an upcharge of 4€. If not indicated, the chair will be produced with plastic glides.*

Needed fabric for material: 1.40 m wide:
Smooth upholstery: 1 m
Soft upholstery: 1 m
Lined upholstery: 1 m

Smooth upholstery

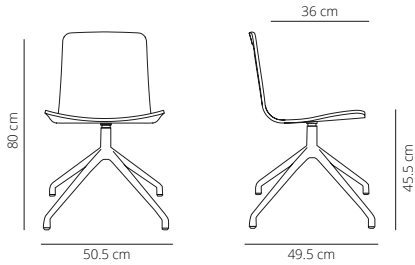

📦 12.9 kg
 📦 (x1) 58x55x88 cm (0.28 m³)

CODE	FINISHES		PUBLIC PRICE
	STRUCTURE	UPHOLSTERY	
KLPIT-1	white, black (microtexturized)	G1(COM/COL)	3.534 DKK
KLPIT-2		G2	3.788 DKK
KLPIT-3		G3	4.051 DKK
KLPIT-4		G4	4.356 DKK
KLPIT-5		G5	4.721 DKK

Soft upholstery

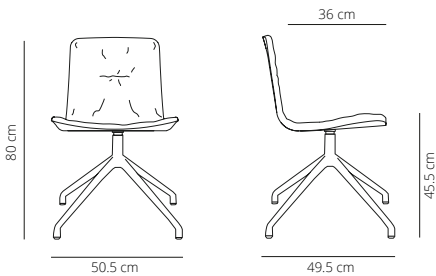

📦 12.9 kg
 📦 (x1) 58x55x88 cm (0.28 m³)

CODE	FINISHES		PUBLIC PRICE
	STRUCTURE	UPHOLSTERY	
KLPITS-1	white, black (microtexturized)	G1(COM/COL)	3.848 DKK
KLPITS-2		G2	4.102 DKK
KLPITS-3		G3	4.356 DKK
KLPITS-4		G4	4.721 DKK
KLPITS-5		G5	5.034 DKK

Lined upholstery

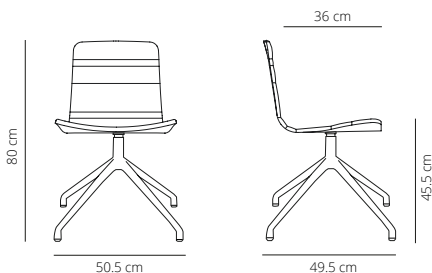

📦 12.9 kg
 📦 (x1) 58x55x88 cm (0.28 m³)

CODE	FINISHES		PUBLIC PRICE
	STRUCTURE	UPHOLSTERY	
KLPIB-1	white, black (microtexturized)	G1(COM/COL)	3.848 DKK
KLPIB-2		G2	4.102 DKK
KLPIB-3		G3	4.356 DKK
KLPIB-4		G4	4.721 DKK
KLPIB-5		G5	5.034 DKK

*Metal or upholstered metal armrests can be added. Accessories available.
 More information on page 183*

+ 4€  **Felt glides available with an upcharge of 4€. If not indicated, the chair will be produced with plastic glides.

Needed fabric for material:
1.40 m wide: 0.7 m

CHAIRS AND STOOLS

Stained/Lacquered with handle and cushion

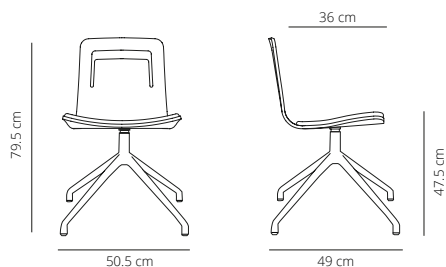

12.9 kg
(x1) 58x55x88 cm (0.28 m³)

CODE	FINISHES			PUBLIC PRICE	
	STRUCTURE	SEAT	UPHOLSTERY		
KLPIROCR-1	white, black (microtexturized)	stained	G1(COM/COL)	3.992 DKK	
KLPIROCR-2			G2	4.314 DKK	
KLPIROCR-3			G3	4.678 DKK	
KLPIROCR-4			G4	4.983 DKK	
KLPIROCR-5			G5	5.297 DKK	
KLPI1CR-1		lacquered	white or black*	G1(COM/COL)	4.153 DKK
KLPI1CR-2				G2	4.526 DKK
KLPI1CR-3				G3	4.822 DKK
KLPI1CR-4				G4	5.144 DKK
KLPI1CR-5				G5	5.449 DKK
KLPI2CR-1	taupe, brick, ochre, olive green, dusty pink or dusty green		G1(COM/COL)	4.314 DKK	
KLPI2CR-2			G2	4.678 DKK	
KLPI2CR-3			G3	4.983 DKK	
KLPI2CR-4			G4	5.297 DKK	
KLPI2CR-5			G5	5.602 DKK	
KLPI3CR-1	bronze	G1(COM/COL)	4.526 DKK		
KLPI3CR-2		G2	4.822 DKK		
KLPI3CR-3		G3	5.144 DKK		
KLPI3CR-4		G4	5.449 DKK		
KLPI3CR-5		G5	5.763 DKK		

Metal or upholstered metal armrests can be added. Accessories available.
More information on page 183

+ 4€  **Felt glides available with an upcharge of 4€. If not indicated, the chair will be produced with plastic glides.

Needed fabric for material:
1.40 m wide: 0.7 m

Stained/Lacquered without handle and with cushion

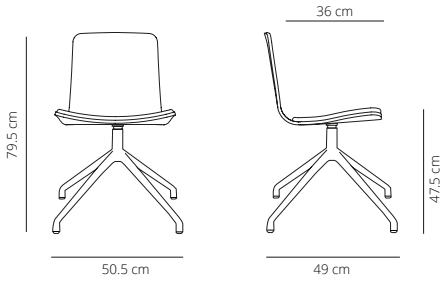

12.9 kg
 (x1) 58x55x88 cm (0.28 m³)

CODE	FINISHES			PUBLIC PRICE	
	STRUCTURE	SEAT	UPHOLSTERY		
KLPIROC-1	white, black (microtexturized)	stained	G1(COM/COL)	3.992 DKK	
KLPIROC-2			G2	4.314 DKK	
KLPIROC-3			G3	4.678 DKK	
KLPIROC-4			G4	4.983 DKK	
KLPIROC-5			G5	5.297 DKK	
KLPI1C-1		lacquered	white or black*	G1(COM/COL)	4.153 DKK
KLPI1C-2				G2	4.526 DKK
KLPI1C-3				G3	4.822 DKK
KLPI1C-4				G4	5.144 DKK
KLPI1C-5				G5	5.449 DKK
KLPI2C-1	taupe, brick, ochre, olive green, dusty pink or dusty green		G1(COM/COL)	4.314 DKK	
KLPI2C-2			G2	4.678 DKK	
KLPI2C-3			G3	4.983 DKK	
KLPI2C-4			G4	5.297 DKK	
KLPI2C-5			G5	5.602 DKK	
KLPI3C-1	bronze	G1(COM/COL)	4.526 DKK		
KLPI3C-2		G2	4.822 DKK		
KLPI3C-3		G3	5.144 DKK		
KLPI3C-4		G4	5.449 DKK		
KLPI3C-5		G5	5.763 DKK		

*Metal or upholstered metal armrests can be added. Accessories available.
More information on page 183*

+ 4€ **Felt glides available with an upcharge of 4€. If not indicated, the chair will be produced with plastic glides.

CHAIRS AND STOOLS

Test certificates: ANSI BIFMA X5.4:2012 (for every seat finishing, only without armrest)

Injected swivel aluminium base powder coated in thermoreinforced polyester in black or white microtexturized with black or white casters for soft floors.

**The whole range of colours has a smooth lacquered finish except black, which has a lacquered microtextured finish.*

NOTE: Due to the fact that the wood used is natural, the finish may vary.

PYRAMID SWIVEL WITH CASTERS BASE

Stained / Lacquered with handle

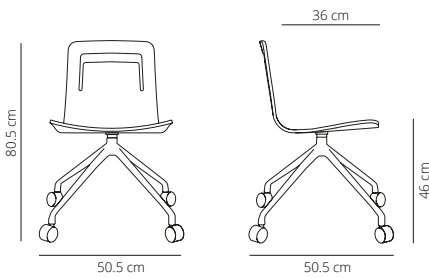

13.1kg
(x1) 58x55x88 cm (0.28 m³)

CODE	FINISHES		PUBLIC PRICE	
	STRUCTURE	SEAT		
KLPIRUROR	white, black (microtexturized)	stained	matt oak, cognac, ash, bleached oak or walnut 3.220 DKK	
KLPIRUTXR		lacquered	white or black*	3.365 DKK
			taupe, brick, ochre, olive green, dusty pink or dusty green	3.534 DKK
		bronze	3.687 DKK	

Stained / Lacquered without handle

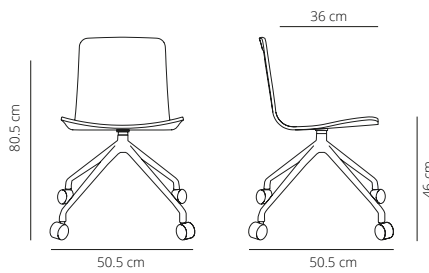

13.1kg
(x1) 58x55x88 cm (0.28 m³)

CODE	FINISHES		PUBLIC PRICE	
	STRUCTURE	SEAT		
KLPIRURO	white, black (microtexturized)	stained	matt oak, cognac, ash, bleached oak or walnut 3.220 DKK	
KLPIRUTX		lacquered	white or black*	3.365 DKK
			taupe, brick, ochre, olive green, dusty pink or dusty green	3.534 DKK
		bronze	3.687 DKK	

*Metal or upholstered metal armrests can be added. Accessories available.
More information on page 183*

Needed fabric for material: 1.40 m wide:
Smooth upholstery: 1 m
Soft upholstery: 1 m
Lined upholstery: 1 m

Smooth upholstery

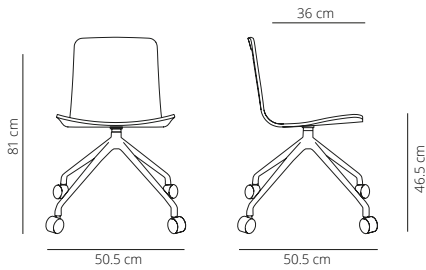

📦 13.1 kg
 📦 (x1) 58x55x88 cm (0.28 m³)

Soft upholstery

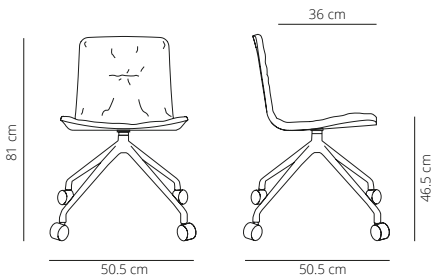

📦 13.1 kg
 📦 (x1) 58x55x88 cm (0.28 m³)

Lined upholstery

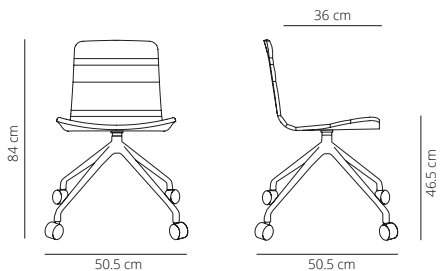

📦 13.1 kg
 📦 (x1) 58x55x88 cm (0.28 m³)

CODE	FINISHES		PUBLIC PRICE
	STRUCTURE	UPHOLSTERY	
KLPIRUT-1	white, black (microtexturized)	G1(COM/COL)	3.687 DKK
KLPIRUT-2		G2	3.941 DKK
KLPIRUT-3		G3	4.204 DKK
KLPIRUT-4		G4	4.568 DKK
KLPIRUT-5		G5	4.890 DKK

CODE	FINISHES		PUBLIC PRICE
	STRUCTURE	UPHOLSTERY	
KLPIRUTS-1	white, black (microtexturized)	G1(COM/COL)	3.992 DKK
KLPIRUTS-2		G2	4.254 DKK
KLPIRUTS-3		G3	4.568 DKK
KLPIRUTS-4		G4	4.890 DKK
KLPIRUTS-5		G5	5.187 DKK

CODE	FINISHES		PUBLIC PRICE
	STRUCTURE	UPHOLSTERY	
KLPIRUB-1	white, black (microtexturized)	G1(COM/COL)	3.992 DKK
KLPIRUB-2		G2	4.254 DKK
KLPIRUB-3		G3	4.568 DKK
KLPIRUB-4		G4	4.890 DKK
KLPIRUB-5		G5	5.187 DKK

*Metal or upholstered metal armrests can be added. Accessories available.
 More information on page 183*

Needed fabric for material:
1.40 m wide: 0.7 m

CHAIRS AND STOOLS

Stained/ Lacquered with handle and cushion

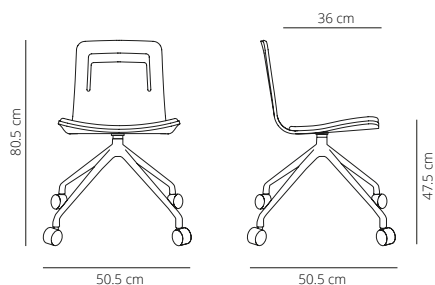

13.1 kg
(x1) 58x55x88 cm (0.28 m³)

CODE	FINISHES			PUBLIC PRICE		
	STRUCTURE	SEAT	UPHOLSTERY			
KLPIRUOCR-1	white, black (microtexturized)	stained	matt oak, cognac, ash, bleached oak or walnut	G1(COM/COL)	4.153 DKK	
KLPIRUOCR-2				G2	4.526 DKK	
KLPIRUOCR-3				G3	4.822 DKK	
KLPIRUOCR-4				G4	5.144 DKK	
KLPIRUOCR-5				G5	5.449 DKK	
KLPIRU1CR-1		lacquered	white or black*	G1(COM/COL)	4.314 DKK	
KLPIRU1CR-2					G2	4.678 DKK
KLPIRU1CR-3					G3	4.983 DKK
KLPIRU1CR-4					G4	5.297 DKK
KLPIRU1CR-5					G5	5.602 DKK
KLPIRU2CR-1			taupe, brick, ochre, olive green, dusty pink or dusty green	G1(COM/COL)	4.526 DKK	
KLPIRU2CR-2					G2	4.822 DKK
KLPIRU2CR-3					G3	5.144 DKK
KLPIRU2CR-4					G4	5.449 DKK
KLPIRU2CR-5					G5	5.763 DKK
KLPIRU3CR-1			bronze	G1(COM/COL)	4.678 DKK	
KLPIRU3CR-2					G2	4.983 DKK
KLPIRU3CR-3					G3	5.297 DKK
KLPIRU3CR-4					G4	5.602 DKK
KLPIRU3CR-5					G5	5.924 DKK

Metal or upholstered metal armrests can be added. Accessories available.
More information on page 183

Needed fabric for material:
1.40 m wide: 0.7 m

**Stained/ Lacquered
without handle and with
cushion**

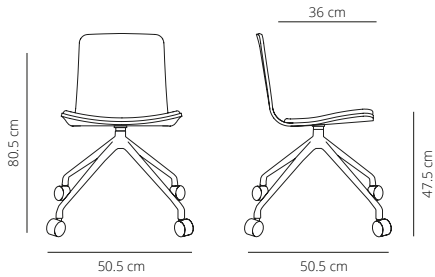

13.1 kg
(x1) 58x55x88 cm (0.28 m³)

CODE	FINISHES			PUBLIC PRICE		
	STRUCTURE	SEAT	UPHOLSTERY			
KLPIRUOC-1		stained	matt oak, cognac, ash, bleached oak or walnut	G1(COM/COL)	4.153 DKK	
KLPIRUOC-2				G2	4.526 DKK	
KLPIRUOC-3				G3	4.822 DKK	
KLPIRUOC-4				G4	5.144 DKK	
KLPIRUOC-5				G5	5.449 DKK	
KLPIRU1C-1	white, black (microtexturized)		white or black*	G1(COM/COL)	4.314 DKK	
KLPIRU1C-2				G2	4.678 DKK	
KLPIRU1C-3				G3	4.983 DKK	
KLPIRU1C-4				G4	5.297 DKK	
KLPIRU1C-5				G5	5.602 DKK	
KLPIRU2C-1		lacquered	taupe, brick, ochre, olive green, dusty pink or dusty green	G1(COM/COL)	4.526 DKK	
KLPIRU2C-2				G2	4.822 DKK	
KLPIRU2C-3				G3	5.144 DKK	
KLPIRU2C-4				G4	5.449 DKK	
KLPIRU2C-5				G5	5.763 DKK	
KLPIRU3C-1			bronze		G1(COM/COL)	4.678 DKK
KLPIRU3C-2					G2	4.983 DKK
KLPIRU3C-3					G3	5.297 DKK
KLPIRU3C-4					G4	5.602 DKK
KLPIRU3C-5					G5	5.924 DKK

*Metal or upholstered metal armrests can be added. Accessories available.
More information on page 183*

CHAIRS AND STOOLS

Test certificates: ANSI BIFMA X5.4:2012 and UNE-EN 16139:2013vc2015 (for every seat finishing, with or without armrest)

Aluminum swivel base powder coated in black or white (high gloss), height adjustment system and black or white soft casters for hard floors.

NOTE: When the base is white, the gas lift tube is chrome finished

**The whole range of colors has a smooth lacquered finish except black, which has a lacquered microtextured finish.*

NOTE: Due to the fact that the wood used is natural, the finish may vary.

FIVE CASTERS BASE

Stained / Lacquered with handle

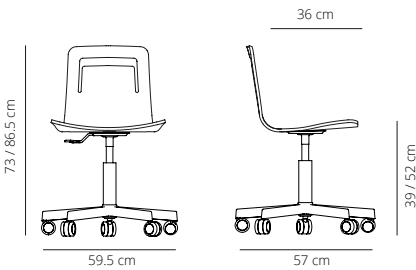

12.5kg
 (x1) 66x65x77cm (0.33 m³)

CODE	FINISHES		PUBLIC PRICE	
	STRUCTURE	SEAT		
KLBROR		stained	matt oak, cognac, ash, bleached oak or walnut	3.220 DKK
KLBRTXR	white or black (high gloss)	lacquered	white or black*	3.365 DKK
			taupe, brick, ochre, olive green, dusty pink or dusty green	3.534 DKK
			bronze	3.687 DKK

Stained / Lacquered without handle

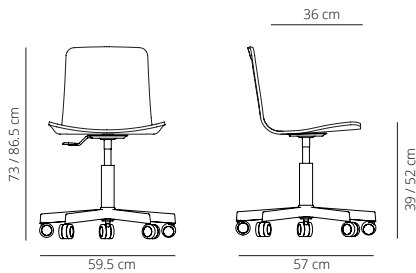

12.5kg
 (x1) 66x65x77cm (0.33 m³)

CODE	FINISHES		PUBLIC PRICE	
	STRUCTURE	SEAT		
KLBRRO		stained	matt oak, cognac, ash, bleached oak or walnut	3.220 DKK
KLBRTX	white or black (high gloss)	lacquered	white or black*	3.365 DKK
			taupe, brick, ochre, olive green, dusty pink or dusty green	3.534 DKK
			bronze	3.687 DKK

Metal or upholstered metal armrests can be added. Accessories available. More information on page 183

Needed fabric for material: 1.40 m wide:
Smooth upholstery: 1 m
Soft upholstery: 1 m
Lined upholstery: 1 m

Smooth upholstery

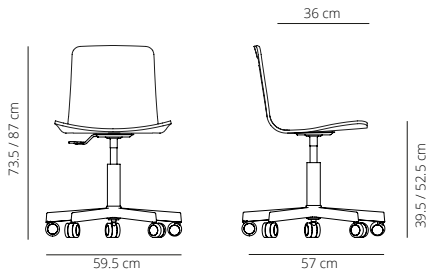

12.5kg
 (x1) 66x65x77cm (0.33 m³)

Soft upholstery

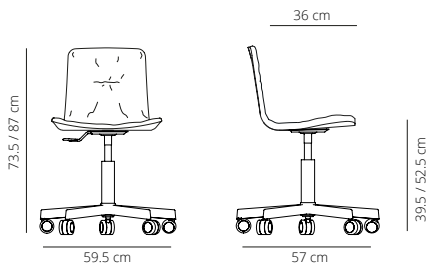

12.5kg
 (x1) 66x65x30.3" (0.33 m³)

Lined upholstery

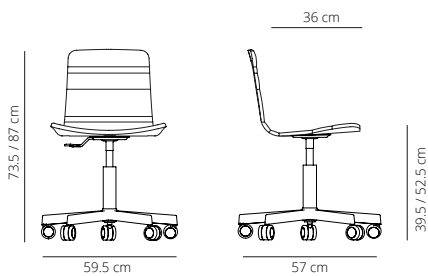

12.5kg
 (x1) 66x65x77cm (0.33 m³)

CODE	FINISHES		PUBLIC PRICE
	STRUCTURE	UPHOLSTERY	
KLBRT-1	white or black (high gloss)	G1(COM/COL)	3.687 DKK
KLBRT-2		G2	3.941 DKK
KLBRT-3		G3	4.204 DKK
KLBRT-4		G4	4.568 DKK
KLBRT-5		G5	4.890 DKK

CODE	FINISHES		PUBLIC PRICE
	STRUCTURE	UPHOLSTERY	
KLBRTS-1	white or black (high gloss)	G1(COM/COL)	3.992 DKK
KLBRTS-2		G2	4.254 DKK
KLBRTS-3		G3	4.568 DKK
KLBRTS-4		G4	4.890 DKK
KLBRTS-5		G5	5.187 DKK

CODE	FINISHES		PUBLIC PRICE
	STRUCTURE	UPHOLSTERY	
KLBRB-1	white or black (high gloss)	G1(COM/COL)	3.992 DKK
KLBRB-2		G2	4.254 DKK
KLBRB-3		G3	4.568 DKK
KLBRB-4		G4	4.890 DKK
KLBRB-5		G5	5.187 DKK

*Metal or upholstered metal armrests can be added. Accessories available.
 More information on page 183*

Needed fabric for material:
1.40 m wide: 0.7 m

Stained/ Lacquered with handle and cushion

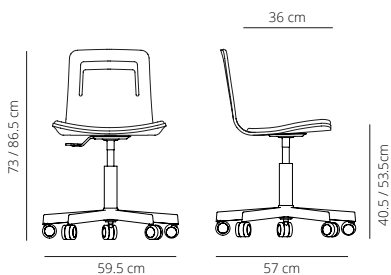

12.5 kg
(x1) 66x65x77cm (0.33 m³)

CODE	FINISHES			PUBLIC PRICE	
	STRUCTURE	SEAT	UPHOLSTERY		
KLBRROCR-1	white or black (high gloss)	stained	G1(COM/COL)	4.153 DKK	
KLBRROCR-2			G2	4.526 DKK	
KLBRROCR-3			G3	4.822 DKK	
KLBRROCR-4			G4	5.144 DKK	
KLBRROCR-5			G5	5.449 DKK	
KLBR1CR-1		lacquered	white or black*	G1(COM/COL)	4.314 DKK
KLBR1CR-2				G2	4.678 DKK
KLBR1CR-3				G3	4.983 DKK
KLBR1CR-4				G4	5.297 DKK
KLBR1CR-5				G5	5.602 DKK
KLBR2CR-1			taupe, brick, ochre, olive green, dusty pink or dusty green	G1(COM/COL)	4.526 DKK
KLBR2CR-2				G2	4.822 DKK
KLBR2CR-3				G3	5.144 DKK
KLBR2CR-4				G4	5.449 DKK
KLBR2CR-5				G5	5.763 DKK
KLBR3CR-1			bronze	G1(COM/COL)	4.678 DKK
KLBR3CR-2				G2	4.983 DKK
KLBR3CR-3				G3	5.297 DKK
KLBR3CR-4				G4	5.602 DKK
KLBR3CR-5				G5	5.924 DKK

Metal or upholstered metal armrests can be added. Accessories available.
More information on page 183

Needed fabric for material:
1.40 m wide: 0.7 m

Stained/ Lacquered without handle and with cushion

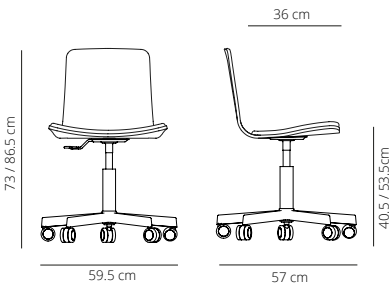

12.5 kg
(x1) 66x65x77cm (0.33 m³)

CODE	FINISHES			PUBLIC PRICE	
	STRUCTURE	SEAT	UPHOLSTERY		
KLBRROC-1	white or black (high gloss)	stained	G1(COM/COL)	4.153 DKK	
KLBRROC-2			G2	4.526 DKK	
KLBRROC-3			G3	4.822 DKK	
KLBRROC-4			G4	5.144 DKK	
KLBRROC-5			G5	5.449 DKK	
KLBR1C-1		lacquered	white or black*	G1(COM/COL)	4.314 DKK
KLBR1C-2				G2	4.678 DKK
KLBR1C-3				G3	4.983 DKK
KLBR1C-4				G4	5.297 DKK
KLBR1C-5				G5	5.602 DKK
KLBR2C-1	taupe, brick, ochre, olive green, dusty pink or dusty green		G1(COM/COL)	4.526 DKK	
KLBR2C-2			G2	4.822 DKK	
KLBR2C-3			G3	5.144 DKK	
KLBR2C-4			G4	5.449 DKK	
KLBR2C-5			G5	5.763 DKK	
KLBR3C-1	bronze	G1(COM/COL)	4.678 DKK		
KLBR3C-2		G2	4.983 DKK		
KLBR3C-3		G3	5.297 DKK		
KLBR3C-4		G4	5.602 DKK		
KLBR3C-5		G5	5.924 DKK		

*Metal or upholstered metal armrests can be added. Accessories available.
More information on page 183*

CHAIRS AND STOOLS

Test certificates: ANSI BIFMA X5.4:2012 and UNE-EN 16139:2013vc2015 (only without armrest)

Injected swivel aluminium base powder coated in thermoreinforced polyester in black or white microtexturized. Black or translucent plastic glides with or without felt.**

**The whole range of colors has a smooth lacquered finish except black, which has a lacquered microtextured finish.*

NOTE: Due to the fact that the wood used is natural, the finish may vary.

FLAT SWIVEL BASE

Stained / Lacquered with handle

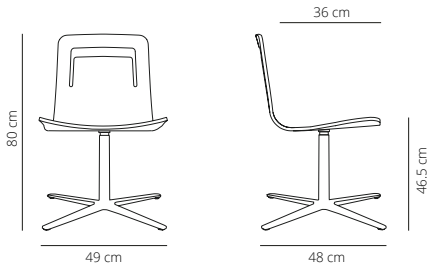

📦 17.2kg
📦 (x1) 58x55x88 cm (0.28 m³)

CODE	FINISHES		PUBLIC PRICE	
	STRUCTURE	SEAT		
KLPLAROR	white, black (microtexturized)	stained	matt oak, cognac, ash, bleached oak or walnut	3.432 DKK
KLPLATXR		lacquered	white or black*	3.576 DKK
			taupe, brick, ochre, olive green, dusty pink or dusty green	3.737 DKK
			bronze	3.898 DKK

Stained / Lacquered without handle

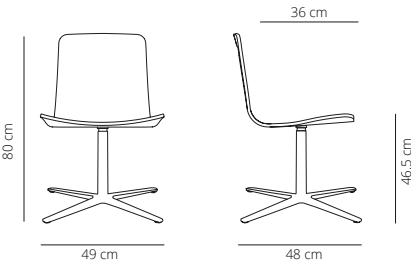

📦 17.2kg
📦 (x1) 58x55x88 cm (0.28 m³)

CODE	FINISHES		PUBLIC PRICE	
	STRUCTURE	SEAT		
KLPLARO	white, black (microtexturized)	stained	matt oak, cognac, ash, bleached oak or walnut	3.432 DKK
KLPLATX		lacquered	white or black*	3.576 DKK
			taupe, brick, ochre, olive green, dusty pink or dusty green	3.737 DKK
			bronze	3.898 DKK

Metal or upholstered metal armrests can be added. Accessories available. More information on page 183

+ 4€  ***Felt glides available with an upcharge of 4€. If not indicated, the chair will be produced with plastic glides.*

Klip

2014, BY VICTOR CARRASCO

CHAIRS AND STOOLS

Needed fabric for material: 1.40 m wide:
Smooth upholstery: 1 m
Soft upholstery: 1 m
Lined upholstery: 1 m

Smooth upholstery

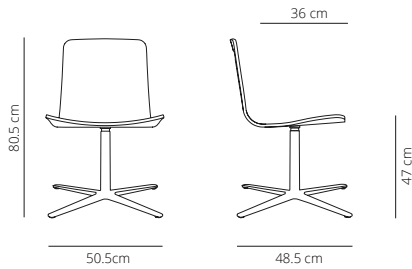

📦 17.8 kg
 📦 (x1) 58x55x88 cm (0.28 m³)

CODE	FINISHES		PUBLIC PRICE
	STRUCTURE	UPHOLSTERY	
KLPLAT-1	white, black (microtexturized)	G1(COM/COL)	3.898 DKK
KLPLAT-2		G2	4.153 DKK
KLPLAT-3		G3	4.415 DKK
KLPLAT-4		G4	4.780 DKK
KLPLAT-5		G5	5.085 DKK

Soft upholstery

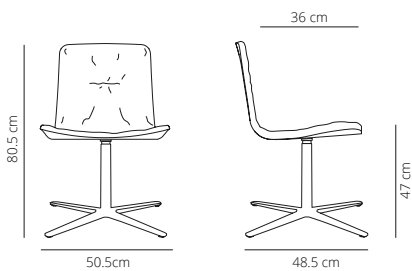

📦 17.8 kg
 📦 (x1) 58x55x88 cm (0.28 m³)

CODE	FINISHES		PUBLIC PRICE
	STRUCTURE	UPHOLSTERY	
KLPLATS-1	white, black (microtexturized)	G1(COM/COL)	4.204 DKK
KLPLATS-2		G2	4.526 DKK
KLPLATS-3		G3	4.780 DKK
KLPLATS-4		G4	5.085 DKK
KLPLATS-5		G5	5.399 DKK

Lined upholstery

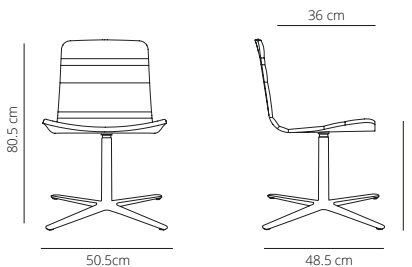

📦 17.8 kg
 📦 (x1) 58x55x88 cm (0.28 m³)

CODE	FINISHES		PUBLIC PRICE
	STRUCTURE	UPHOLSTERY	
KLPLAB-1	white, black (microtexturized)	G1(COM/COL)	4.204 DKK
KLPLAB-2		G2	4.526 DKK
KLPLAB-3		G3	4.780 DKK
KLPLAB-4		G4	5.085 DKK
KLPLAB-5		G5	5.399 DKK

*Metal or upholstered metal armrests can be added. Accessories available.
 More information on page 183*

+ 4€  **Felt glides available with an upcharge of 4€. If not indicated, the chair will be produced with plastic glides.

Needed fabric for material:
1.40 m wide: 0.7 m

Stained/ Lacquered with handle and cushion

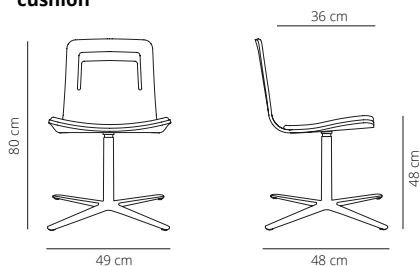

17.8 kg
(x1) 58x55x88 cm (0.28 m³)

CODE	FINISHES			PUBLIC PRICE	
	STRUCTURE	SEAT	UPHOLSTERY		
KLPLAROCR-1	white, black (microtexturized)	stained	G1(COM/COL)	4.356 DKK	
KLPLAROCR-2			G2	4.721 DKK	
KLPLAROCR-3			G3	5.034 DKK	
KLPLAROCR-4			G4	5.348 DKK	
KLPLAROCR-5			G5	5.653 DKK	
KLPLA1CR-1		lacquered	white or black*	G1(COM/COL)	4.568 DKK
KLPLA1CR-2				G2	4.890 DKK
KLPLA1CR-3				G3	5.187 DKK
KLPLA1CR-4				G4	5.509 DKK
KLPLA1CR-5				G5	5.814 DKK
KLPLA2CR-1			taupe, brick, ochre, olive green, dusty pink or dusty green	G1(COM/COL)	4.721 DKK
KLPLA2CR-2				G2	5.034 DKK
KLPLA2CR-3				G3	5.348 DKK
KLPLA2CR-4				G4	5.653 DKK
KLPLA2CR-5				G5	5.966 DKK
KLPLA3CR-1			bronze	G1(COM/COL)	4.890 DKK
KLPLA3CR-2				G2	5.187 DKK
KLPLA3CR-3				G3	5.509 DKK
KLPLA3CR-4				G4	5.814 DKK
KLPLA3CR-5				G5	6.136 DKK

Metal or upholstered metal armrests can be added. Accessories available.
More information on page 183

+ 4€  **Felt glides available with an upcharge of 4€. If not indicated, the chair will be produced with plastic glides.

Needed fabric for material:
1.40 m wide: 0.7 m

**Stained/ Lacquered
without handle and with
cushion**

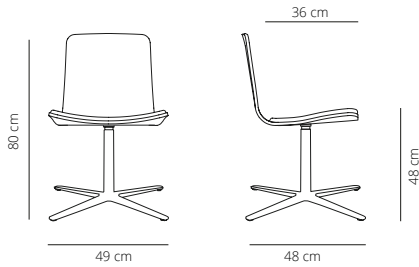

17.8 kg
 (x1) 58x55x88 cm (0.28 m³)

CODE	FINISHES			PUBLIC PRICE	
	STRUCTURE	SEAT	UPHOLSTERY		
KLPLAROC-1	white, black (microtexturized)	stained	G1(COM/COL)	4.356 DKK	
KLPLAROC-2			G2	4.721 DKK	
KLPLAROC-3			G3	5.034 DKK	
KLPLAROC-4			G4	5.348 DKK	
KLPLAROC-5			G5	5.653 DKK	
KLPLA1C-1		lacquered	white or black*	G1(COM/COL)	4.568 DKK
KLPLA1C-2				G2	4.890 DKK
KLPLA1C-3				G3	5.187 DKK
KLPLA1C-4				G4	5.509 DKK
KLPLA1C-5				G5	5.814 DKK
KLPLA2C-1			taupe, brick, ochre, olive green, dusty pink or dusty green	G1(COM/COL)	4.721 DKK
KLPLA2C-2				G2	5.034 DKK
KLPLA2C-3				G3	5.348 DKK
KLPLA2C-4				G4	5.653 DKK
KLPLA2C-5				G5	5.966 DKK
KLPLA3C-1			bronze	G1(COM/COL)	4.890 DKK
KLPLA3C-2				G2	5.187 DKK
KLPLA3C-3				G3	5.509 DKK
KLPLA3C-4				G4	5.814 DKK
KLPLA3C-5				G5	6.136 DKK

*Metal or upholstered metal armrests can be added. Accessories available.
More information on page 183*

+ 4€ **Felt glides available with an upcharge of 4€. If not indicated, the chair will be produced with plastic glides.

CHAIRS AND STOOLS

Test certificates: ANSI BIFMA X5.4:2012 and UNE-EN 16139:2013vc2015 (for all seat finishings, with or without armrest)

Calibrated steel swivel structure powder coated in thermoreinforced polyester in white, black, taupe or fluorescent orange. Black or white plastic glides, with or without felt.**

**The whole range of colors has a smooth lacquered finish except black, which has a lacquered microtextured finish.*

NOTE: Due to the fact that the wood used is natural, the finish may vary.

SWIVEL COUNTER STOOL

Stained / Lacquered with handle

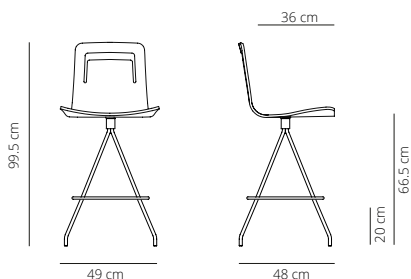

17.2kg
(x1) 57.5x53.5x110cm (0.33 m³)

CODE	FINISHES		PUBLIC PRICE	
	STRUCTURE	SEAT		
KLTCOROR	black or white	stained	3.898 DKK matt oak, cognac, ash, bleached oak or walnut	
KLTCOTXR		lacquered	white or black*	4.102 DKK
			taupe, brick, ochre, olive green, dusty pink or dusty green	4.254 DKK
			bronze	4.415 DKK

Stained / Lacquered without handle

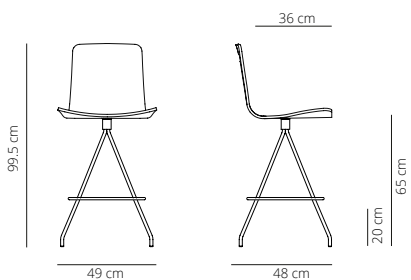

17.2kg
(x1) 57.5x53.5x110cm (0.33 m³)

CODE	FINISHES		PUBLIC PRICE	
	STRUCTURE	SEAT		
KLTCORO	black or white	stained	3.898 DKK matt oak, cognac, ash, bleached oak or walnut	
KLTCOTX		lacquered	white or black*	4.102 DKK
			taupe, brick, ochre, olive green, dusty pink or dusty green	4.254 DKK
			bronze	4.415 DKK

Metal or upholstered metal armrests can be added. Accessories available. More information on page 183

+ 4€  ***Felt glides available with an upcharge of 4€. If not indicated, the stool will be produced with plastic glides.*

Needed fabric for material: 1.40 m wide:
Smooth upholstery: 1 m
Soft upholstery: 1 m
Lined upholstery: 1 m

Smooth upholstery

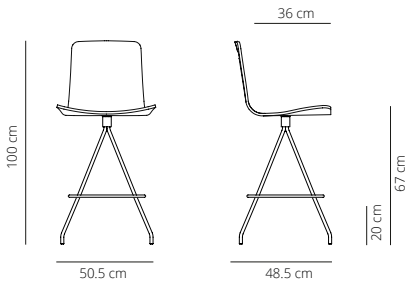

17.2kg
 (x1) 57.5x53.5x110cm (0.33 m³)

CODE	FINISHES		PUBLIC PRICE
	STRUCTURE	UPHOLSTERY	
KLTCOT-1	black or white	G1(COM/COL)	3.898 DKK
KLTCOT-2		G2	4.254 DKK
KLTCOT-3		G3	4.721 DKK
KLTCOT-4		G4	5.187 DKK
KLTCOT-5		G5	5.712 DKK

Soft upholstery

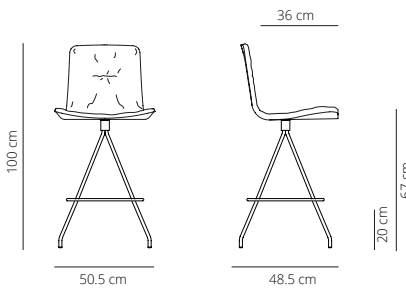

17.2 kg
 (x1) 57.5x53.5x110cm (0.33 m³)

CODE	FINISHES		PUBLIC PRICE
	STRUCTURE	UPHOLSTERY	
KLTCOTS-1	black or white	G1(COM/COL)	4.204 DKK
KLTCOTS-2		G2	4.610 DKK
KLTCOTS-3		G3	5.034 DKK
KLTCOTS-4		G4	5.509 DKK
KLTCOTS-5		G5	6.026 DKK

Lined upholstery

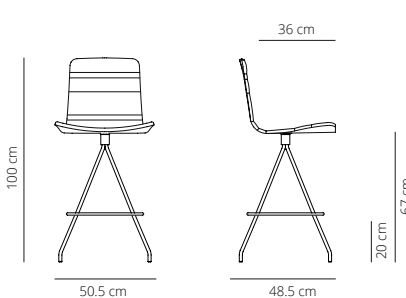

17.2 kg
 (x1) 57.5x53.5x110cm (0.33 m³)

CODE	FINISHES		PUBLIC PRICE
	STRUCTURE	UPHOLSTERY	
KLTCOB-1	black or white	G1(COM/COL)	4.204 DKK
KLTCOB-2		G2	4.610 DKK
KLTCOB-3		G3	5.034 DKK
KLTCOB-4		G4	5.509 DKK
KLTCOB-5		G5	6.026 DKK

*Metal or upholstered metal armrests can be added. Accessories available.
 More information on page 183*

+ 4€  **Felt glides available with an upcharge of 4€. If not indicated, the stool will be produced with plastic glides.

Needed fabric for material:
1.40 m wide: 0.7 m

CHAIRS AND STOOLS

Stained/ Lacquered with handle and cushion

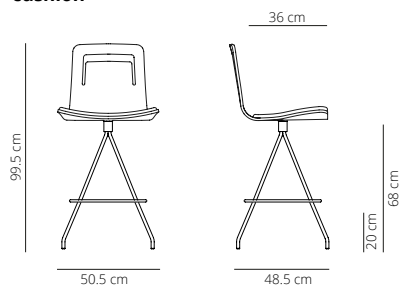

17.2 kg
(x1) 57.5x53.5x110cm (0.33 m³)

CODE	FINISHES			PUBLIC PRICE		
	STRUCTURE	SEAT	UPHOLSTERY			
KLTCOROCR-1		stained	matt oak, cognac, ash, bleached oak or walnut	G1(COM/COL)	4.890 DKK	
KLTCOROCR-2				G2	5.187 DKK	
KLTCOROCR-3				G3	5.509 DKK	
KLTCOROCR-4				G4	5.814 DKK	
KLTCOROCR-5				G5	6.136 DKK	
KLTCO1CR-1	black or white		white or black*	G1(COM/COL)	5.085 DKK	
KLTCO1CR-2				G2	5.399 DKK	
KLTCO1CR-3				G3	5.712 DKK	
KLTCO1CR-4				G4	6.026 DKK	
KLTCO1CR-5				G5	6.390 DKK	
KLTCO2CR-1		lacquered		taupe, brick, ochre, olive green, dusty pink or dusty green	G1(COM/COL)	5.238 DKK
KLTCO2CR-2					G2	5.560 DKK
KLTCO2CR-3					G3	5.856 DKK
KLTCO2CR-4					G4	6.178 DKK
KLTCO2CR-5					G5	6.543 DKK
KLTCO3CR-1		bronze		G1(COM/COL)	5.399 DKK	
KLTCO3CR-2				G2	5.712 DKK	
KLTCO3CR-3				G3	6.026 DKK	
KLTCO3CR-4				G4	6.390 DKK	
KLTCO3CR-5				G5	6.687 DKK	

Metal or upholstered metal armrests can be added. Accessories available.
More information on page 183

+ 4€  **Felt glides available with an upcharge of 4€. If not indicated, the stool will be produced with plastic glides.

Needed fabric for material:
1.40 m wide: 0.7 m

**Stained/ Lacquered
without handle and with
cushion**

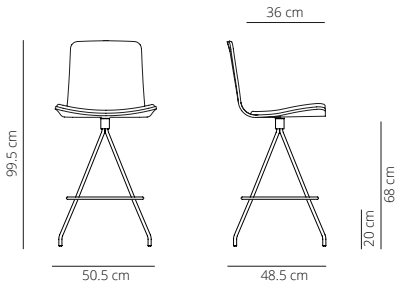

📦 17.2 kg
📦 (x1) 57.5x53.5x110cm (0.33 m³)

CODE	FINISHES			PUBLIC PRICE	
	STRUCTURE	SEAT	UPHOLSTERY		
KLTCOROC-1	black or white	stained	G1(COM/COL)	4.890 DKK	
KLTCOROC-2			G2	5.187 DKK	
KLTCOROC-3			G3	5.509 DKK	
KLTCOROC-4			G4	5.814 DKK	
KLTCOROC-5			G5	6.136 DKK	
KLTCO1C-1		lacquered	white or black*	G1(COM/COL)	5.085 DKK
KLTCO1C-2				G2	5.399 DKK
KLTCO1C-3				G3	5.712 DKK
KLTCO1C-4				G4	6.026 DKK
KLTCO1C-5				G5	6.390 DKK
KLTCO2C-1	lacquered	taupe, brick, ochre, olive green, dusty pink or dusty green	G1(COM/COL)	5.238 DKK	
KLTCO2C-2			G2	5.560 DKK	
KLTCO2C-3			G3	5.856 DKK	
KLTCO2C-4			G4	6.178 DKK	
KLTCO2C-5			G5	6.543 DKK	
KLTCO3C-1	lacquered	bronze	G1(COM/COL)	5.399 DKK	
KLTCO3C-2			G2	5.712 DKK	
KLTCO3C-3			G3	6.026 DKK	
KLTCO3C-4			G4	6.390 DKK	
KLTCO3C-5			G5	6.687 DKK	

*Metal or upholstered metal armrests can be added. Accessories available.
More information on page 183*

+ 4€  **Felt glides available with an upcharge of 4€. If not indicated, the stool will be produced with plastic glides.

CHAIRS AND STOOLS

Test certificates: ANSI BIFMA X5.4:2012 and UNE-EN 16139:2013vc2015 (for all seat finishings with or without armrest)

Calibrated steel swivel structure powder coated in thermoreinforced polyester in white, black, taupe or fluorescent orange. Black or white plastic glides, with or without felt.**

**The whole range of colors has a smooth lacquered finish except black, which has a lacquered microtextured finish.*

NOTE: Due to the fact that the wood used is natural, the finish may vary.

SWIVEL BAR STOOL

Stained / Lacquered with handle

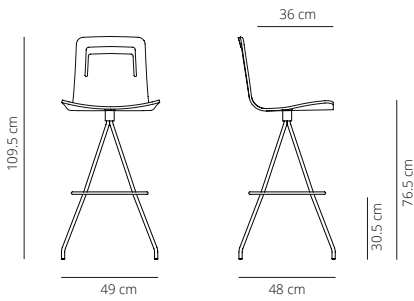

17.8 kg
(x1) 57.5x53.5x114 cm (0.37 m³)

CODE	FINISHES		PUBLIC PRICE	
	STRUCTURE	SEAT		
KLTBARROR	black or white	stained	matt oak, cognac, ash, bleached oak or walnut	3.898 DKK
KLTBARTXR		lacquered	white or black*	4.102 DKK
			taupe, brick, ochre, olive green, dusty pink or dusty green	4.254 DKK
			bronze	4.415 DKK

Stained / Lacquered without handle

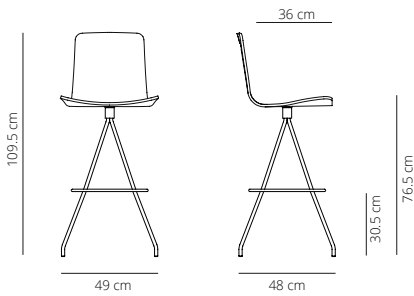

17.8 kg
(x1) 57.5x53.5x114 cm (0.37 m³)

CODE	FINISHES		PUBLIC PRICE	
	STRUCTURE	SEAT		
KLTBARRO	black or white	stained	matt oak, cognac, ash, bleached oak or walnut	3.898 DKK
KLTBARTX		lacquered	white or black*	4.102 DKK
			taupe, brick, ochre, olive green, dusty pink or dusty green	4.254 DKK
			bronze	4.415 DKK

Metal or upholstered metal armrests can be added. Accessories available. More information on page 183

+ 4€  ***Felt glides available with an upcharge of 4€. If not indicated, the stool will be produced with plastic glides.*

Needed fabric for material: 1.40 m wide:
Smooth upholstery: 1 m
Soft upholstery: 1 m
Lined upholstery: 1 m

Smooth upholstery

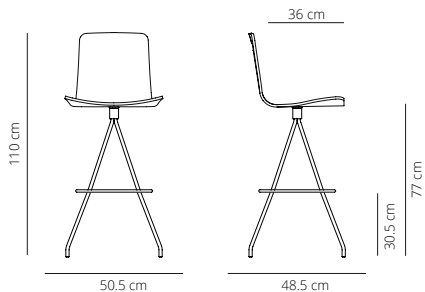

17.8 kg

(x1) 57.5x53.5x114 cm (0.37 m³)

CODE	FINISHES		PUBLIC PRICE
	STRUCTURE	UPHOLSTERY	
KLTBART-1	black or white	G1(COM/COL)	3.898 DKK
KLTBART-2		G2	4.254 DKK
KLTBART-3		G3	4.721 DKK
KLTBART-4		G4	5.187 DKK
KLTBART-5		G5	5.712 DKK

Soft upholstery

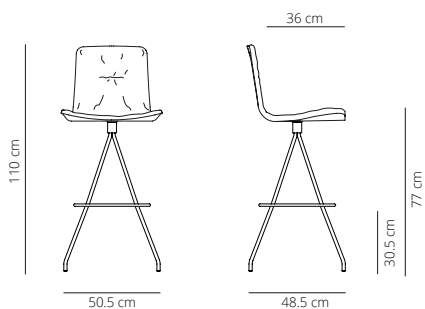

17.8 kg

(x1) 57.5x53.5x114 cm (0.37 m³)

CODE	FINISHES		PUBLIC PRICE
	STRUCTURE	UPHOLSTERY	
KLTBARTS-1	black or white	G1(COM/COL)	4.204 DKK
KLTBARTS-2		G2	4.610 DKK
KLTBARTS-3		G3	5.034 DKK
KLTBARTS-4		G4	5.509 DKK
KLTBARTS-5		G5	6.026 DKK

Lined upholstery

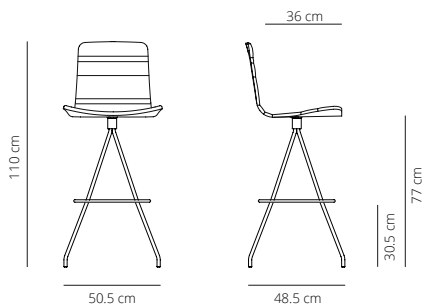

17.8 kg

(x1) 57.5x53.5x114 cm (0.37 m³)

CODE	FINISHES		PUBLIC PRICE
	STRUCTURE	UPHOLSTERY	
KLTBARB-1	black or white	G1(COM/COL)	4.204 DKK
KLTBARB-2		G2	4.610 DKK
KLTBARB-3		G3	5.034 DKK
KLTBARB-4		G4	5.509 DKK
KLTBARB-5		G5	6.026 DKK

*Metal or upholstered metal armrests can be added. Accessories available.
 More information on page 183*

+ 4€  ***Felt glides available with an upcharge of 4€. If not indicated, the stool will be produced with plastic glides.*

Needed fabric for material:
1.40 m wide: 0.7 m

CHAIRS AND STOOLS

Stained/ Lacquered with handle and cushion

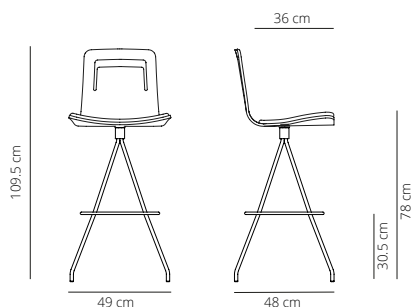

17.8 kg
(x1) 55x67x114ccm (0.42 m³)

CODE	FINISHES			PUBLIC PRICE
	STRUCTURE	SEAT	UPHOLSTERY	
KLTBARROCR-1	black or white	stained	G1(COM/COL)	4.890 DKK
KLTBARROCR-2			G2	5.187 DKK
KLTBARROCR-3			G3	5.509 DKK
KLTBARROCR-4			G4	5.814 DKK
KLTBARROCR-5			G5	6.136 DKK
KLTBAR1CR-1		white or black*	G1(COM/COL)	5.085 DKK
KLTBAR1CR-2			G2	5.399 DKK
KLTBAR1CR-3			G3	5.712 DKK
KLTBAR1CR-4			G4	6.026 DKK
KLTBAR1CR-5			G5	6.390 DKK
KLTBAR2CR-1	lacquered	taupe, brick, ochre, olive green, dusty pink or dusty green	G1(COM/COL)	5.238 DKK
KLTBAR2CR-2			G2	5.560 DKK
KLTBAR2CR-3			G3	5.856 DKK
KLTBAR2CR-4			G4	6.178 DKK
KLTBAR2CR-5			G5	6.543 DKK
KLTBAR3CR-1	bronze		G1(COM/COL)	5.399 DKK
KLTBAR3CR-2			G2	5.712 DKK
KLTBAR3CR-3			G3	6.026 DKK
KLTBAR3CR-4			G4	6.390 DKK
KLTBAR3CR-5			G5	6.687 DKK

Metal or upholstered metal armrests can be added. Accessories available.
More information on page 183

+ 4€  **Felt glides available with an upcharge of 4€. If not indicated, the stool will be produced with plastic glides.

Needed fabric for material:
1.40 m wide: 0.7 m

Stained/ Lacquered without handle and with cushion

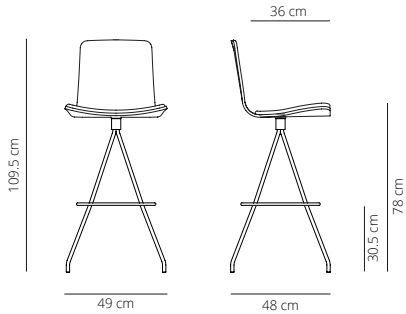

📦 17.8 kg
📦 (x1) 55x67x114 cm (0.42 m³)

CODE	FINISHES			PUBLIC PRICE	
	STRUCTURE	SEAT	UPHOLSTERY		
KLTBARROC-1		stained	G1(COM/COL)	4.890 DKK	
KLTBARROC-2			G2	5.187 DKK	
KLTBARROC-3			G3	5.509 DKK	
KLTBARROC-4			G4	5.814 DKK	
KLTBARROC-5			G5	6.136 DKK	
KLTBAR1C-1		black or white	white or black*	G1(COM/COL)	5.085 DKK
KLTBAR1C-2				G2	5.399 DKK
KLTBAR1C-3				G3	5.712 DKK
KLTBAR1C-4				G4	6.026 DKK
KLTBAR1C-5				G5	6.390 DKK
KLTBAR2C-1		lacquered	G1(COM/COL)	5.238 DKK	
KLTBAR2C-2			G2	5.560 DKK	
KLTBAR2C-3			G3	5.856 DKK	
KLTBAR2C-4			G4	6.178 DKK	
KLTBAR2C-5			G5	6.543 DKK	
KLTBAR3C-1		bronze	G1(COM/COL)	5.399 DKK	
KLTBAR3C-2			G2	5.712 DKK	
KLTBAR3C-3			G3	6.026 DKK	
KLTBAR3C-4			G4	6.390 DKK	
KLTBAR3C-5			G5	6.687 DKK	

*Metal or upholstered metal armrests can be added. Accessories available.
More information on page 183*

+ 4€  ***Felt glides available with an upcharge of 4€. If not indicated, the stool will be produced with plastic glides.*

CHAIRS AND STOOLS

Test certificates: ANSI BIFMA X5.4:2020 and UNE-EN 16139:2013vc2015 (for all seat finishings, with or without armrest)

Calibrated steel structure powder coated in thermoreinforced polyester in white or black. Black or white plastic glides with or without felt.**

**The whole range of colors has a smooth lacquered finish except black, which has a lacquered microtextured finish.*

NOTE: Due to the fact that the wood used is natural, the finish may vary.

FIXED COUNTER STOOL

Stained / Lacquered with handle

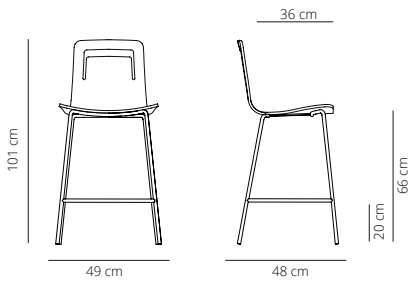

8.3 kg
 (x1) 107x55x55 cm (0.32 m³)

CODE	FINISHES		PUBLIC PRICE	
	STRUCTURE	SEAT		
KLTFCOROR	black or white	stained	matt oak, cognac, ash, bleached oak or walnut	2.856 DKK
KLTFCOTXR		lacquered	white or black*	3.170 DKK
			taupe, brick, ochre, olive green, dusty pink or dusty green	3.322 DKK
			bronze	3.432 DKK

Stained / Lacquered without handle

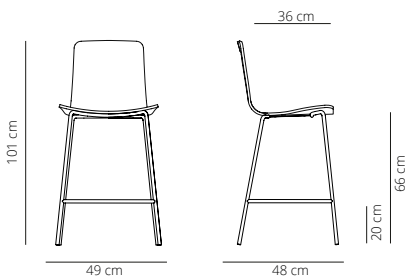

8.6 kg
 (x1) 107x55x55 cm (0.32 m³)

CODE	FINISHES		PUBLIC PRICE	
	STRUCTURE	SEAT		
KLTFCORO	black or white	stained	matt oak, cognac, ash, bleached oak or walnut	2.856 DKK
KLTFCOTX		lacquered	white or black*	3.170 DKK
			taupe, brick, ochre, olive green, dusty pink or dusty green	3.322 DKK
			bronze	3.432 DKK

Metal or upholstered metal armrests can be added. Accessories available. More information on page 183

+ 4€  ***Felt glides available with an upcharge of 4€. If not indicated, the stool will be produced with plastic glides.*

Needed fabric for material: 1.40 m wide:
Smooth upholstery: 1 m
Soft upholstery: 1 m
Lined upholstery: 1 m

Smooth upholstery

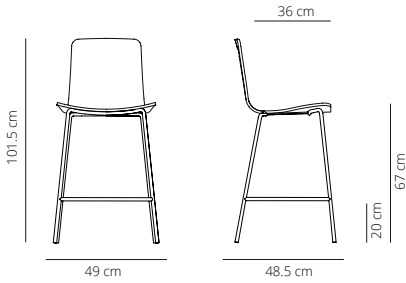

9.5 kg
 (x1) 107x55x55 cm (0.32 m³)

Soft upholstery

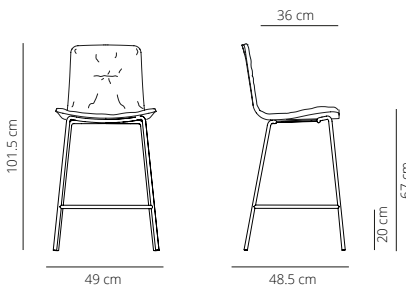

9.8 kg
 (x1) 107x55x55 cm (0.32 m³)

Lined upholstery

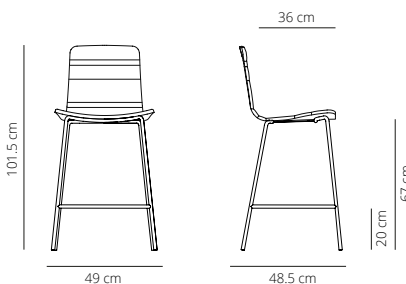

9.8 kg
 (x1) 107x55x55 cm (0.32 m³)

CODE	FINISHES		PUBLIC PRICE
	STRUCTURE	UPHOLSTERY	
KLFCOT-1	black or white	G1(COM/COL)	3.322 DKK
KLFCOT-2		G2	3.534 DKK
KLFCOT-3		G3	3.898 DKK
KLFCOT-4		G4	4.254 DKK
KLFCOT-5		G5	4.678 DKK

CODE	FINISHES		PUBLIC PRICE
	STRUCTURE	UPHOLSTERY	
KLFCOTS-1	black or white	G1(COM/COL)	3.636 DKK
KLFCOTS-2		G2	3.848 DKK
KLFCOTS-3		G3	4.153 DKK
KLFCOTS-4		G4	4.610 DKK
KLFCOTS-5		G5	4.983 DKK

CODE	FINISHES		PUBLIC PRICE
	STRUCTURE	UPHOLSTERY	
KLFCOB-1	black or white	G1(COM/COL)	3.636 DKK
KLFCOB-2		G2	3.848 DKK
KLFCOB-3		G3	4.153 DKK
KLFCOB-4		G4	4.610 DKK
KLFCOB-5		G5	4.983 DKK

*Metal or upholstered metal armrests can be added. Accessories available.
 More information on page 183*

+ 4€  **Felt glides available with an upcharge of 4€. If not indicated, the stool will be produced with plastic glides.

Needed fabric for material:
1.40 m wide: 0.7 m

CHAIRS AND STOOLS

Stained/ Lacquered with handle and cushion

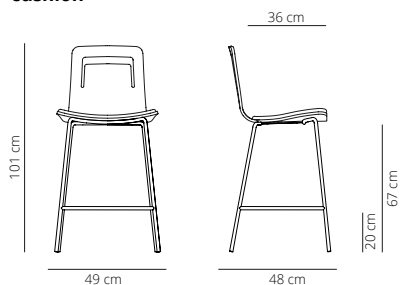

9.6 kg
(x1) 107x55x55 cm (0.32 m³)

CODE	FINISHES			PUBLIC PRICE	
	STRUCTURE	SEAT	UPHOLSTERY		
KLTFCOROCR-1	black or white	stained	G1(COM/COL)	3.534 DKK	
KLTFCOROCR-2			G2	3.636 DKK	
KLTFCOROCR-3			G3	3.788 DKK	
KLTFCOROCR-4			G4	3.992 DKK	
KLTFCOROCR-5			G5	4.204 DKK	
KLTFCO1CR-1		lacquered	white or black*	G1(COM/COL)	3.848 DKK
KLTFCO1CR-2				G2	3.941 DKK
KLTFCO1CR-3				G3	4.102 DKK
KLTFCO1CR-4				G4	4.314 DKK
KLTFCO1CR-5				G5	4.568 DKK
KLTFCO2CR-1			taupe, brick, ochre, olive green, dusty pink or dusty green	G1(COM/COL)	3.992 DKK
KLTFCO2CR-2				G2	4.102 DKK
KLTFCO2CR-3				G3	4.254 DKK
KLTFCO2CR-4				G4	4.526 DKK
KLTFCO2CR-5				G5	4.721 DKK
KLTFCO3CR-1			bronze	G1(COM/COL)	4.102 DKK
KLTFCO3CR-2				G2	4.204 DKK
KLTFCO3CR-3				G3	4.356 DKK
KLTFCO3CR-4				G4	4.610 DKK
KLTFCO3CR-5				G5	4.822 DKK

Metal or upholstered metal armrests can be added. Accessories available.
More information on page 183

+ 4€  **Felt glides available with an upcharge of 4€. If not indicated, the stool will be produced with plastic glides.

Needed fabric for material:
1.40 m wide: 0.7 m

Stained/ Lacquered without handle and with cushion

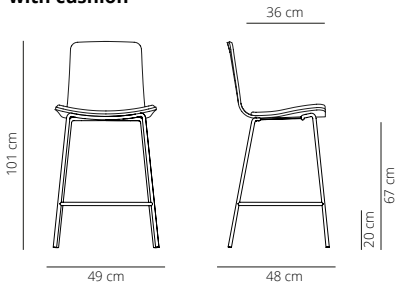

9.9 kg
(x1) 107x55x55 cm (0.32 m³)

CODE	FINISHES			PUBLIC PRICE	
	STRUCTURE	SEAT	UPHOLSTERY		
KLTFCOROC-1	black or white	stained	G1(COM/COL)	3.534 DKK	
KLTFCOROC-2			G2	3.636 DKK	
KLTFCOROC-3			G3	3.788 DKK	
KLTFCOROC-4			G4	3.992 DKK	
KLTFCOROC-5			G5	4.204 DKK	
KLTFCO1C-1		lacquered	white or black*	G1(COM/COL)	3.848 DKK
KLTFCO1C-2				G2	3.941 DKK
KLTFCO1C-3				G3	4.102 DKK
KLTFCO1C-4				G4	4.314 DKK
KLTFCO1C-5				G5	4.568 DKK
KLTFCO2C-1	taupe, brick, ochre, olive green, dusty pink or dusty green		G1(COM/COL)	3.992 DKK	
KLTFCO2C-2			G2	4.102 DKK	
KLTFCO2C-3			G3	4.254 DKK	
KLTFCO2C-4			G4	4.526 DKK	
KLTFCO2C-5			G5	4.721 DKK	
KLTFCO3C-1	bronze		G1(COM/COL)	4.102 DKK	
KLTFCO3C-2			G2	4.204 DKK	
KLTFCO3C-3			G3	4.356 DKK	
KLTFCO3C-4			G4	4.610 DKK	
KLTFCO3C-5			G5	4.822 DKK	

Metal or upholstered metal armrests can be added. Accessories available.
More information on page 183

+ 4€  **Felt glides available with an upcharge of 4€. If not indicated, the stool will be produced with plastic glides.

CHAIRS AND STOOLS

Test certificates: ANSI BIFMA X5.4:2020 and UNE-EN 16139:2013vc2015 (for all seat finishings, with or without armrest)

Calibrated steel structure powder coated in thermoreinforced polyester in white or black. Black or white plastic glides with or without felt.**

**The whole range of colors has a smooth lacquered finish except black, which has a lacquered microtextured finish.*

NOTE: Due to the fact that the wood used is natural, the finish may vary.

FIXED BAR STOOL

Stained / Lacquered with handle

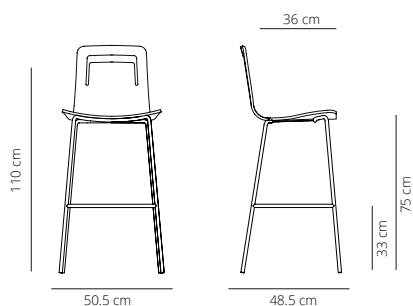

8.8 kg
 (x1) 116x55x55 cm (0.35 m³)

CODE	FINISHES		PUBLIC PRICE	
	STRUCTURE	SEAT		
KLTFBARROR	black or white	stained	matt oak, cognac, ash, bleached oak or walnut 2.856 DKK	
KLTFBARTXR		lacquered	white or black*	3.170 DKK
			taupe, brick, ochre, olive green, dusty pink or dusty green	3.322 DKK
		bronze	3.432 DKK	

Stained / Lacquered without handle

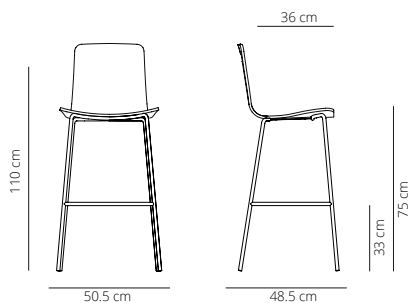

9.1 kg
 (x1) 116x55x55 cm (0.35 m³)

CODE	FINISHES		PUBLIC PRICE	
	STRUCTURE	SEAT		
KLTFBARRO	black or white	stained	matt oak, cognac, ash, bleached oak or walnut 2.856 DKK	
KLTFBARTX		lacquered	white or black*	3.170 DKK
			taupe, brick, ochre, olive green, dusty pink or dusty green	3.322 DKK
		bronze	3.432 DKK	

Metal or upholstered metal armrests can be added. Accessories available. More information on page 183

+ 4€  ***Felt glides available with an upcharge of 4€. If not indicated, the stool will be produced with plastic glides.*

Needed fabric for material: 1.40 m wide:
Smooth upholstery: 1 m
Soft upholstery: 1 m
Lined upholstery: 1 m

Smooth upholstery

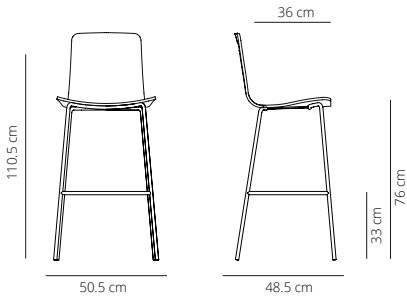

👤 10.0 kg
 📦 (x1) 116x55x55 cm (0.35 m³)

Soft upholstery

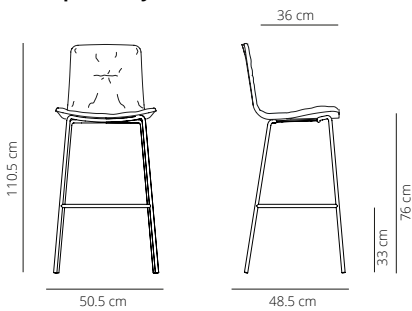

👤 10.3 kg
 📦 (x1) 116x55x55 cm (0.35 m³)

Lined upholstery

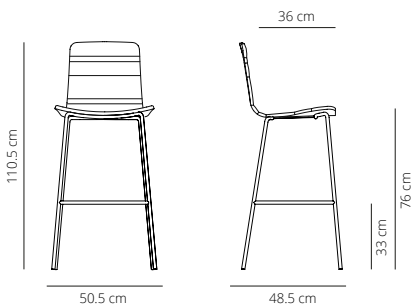

👤 10.3 kg
 📦 (x1) 116x55x55 cm (0.35 m³)

CODE	FINISHES		PUBLIC PRICE
	STRUCTURE	UPHOLSTERY	
KLTFBART-1	black or white	G1(COM/COL)	3.322 DKK
KLTFBART-2		G2	3.534 DKK
KLTFBART-3		G3	3.898 DKK
KLTFBART-4		G4	4.254 DKK
KLTFBART-5		G5	4.678 DKK

CODE	FINISHES		PUBLIC PRICE
	STRUCTURE	UPHOLSTERY	
KLTFBARTS-1	black or white	G1(COM/COL)	3.636 DKK
KLTFBARTS-2		G2	3.848 DKK
KLTFBARTS-3		G3	4.153 DKK
KLTFBARTS-4		G4	4.610 DKK
KLTFBARTS-5		G5	4.983 DKK

CODE	FINISHES		PUBLIC PRICE
	STRUCTURE	UPHOLSTERY	
KLTFBARB-1	black or white	G1(COM/COL)	3.636 DKK
KLTFBARB-2		G2	3.848 DKK
KLTFBARB-3		G3	4.153 DKK
KLTFBARB-4		G4	4.610 DKK
KLTFBARB-5		G5	4.983 DKK

*Metal or upholstered metal armrests can be added. Accessories available.
 More information on page 183*

+ 4€  **Felt glides available with an upcharge of 4€. If not indicated, the stool will be produced with plastic glides.

Needed fabric for material:
1.40 m wide: 0.7 m

Stained/ Lacquered with handle and cushion

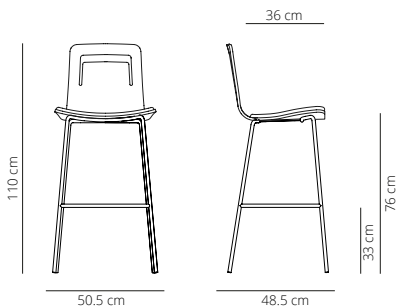

10.1 kg
(x1) 116x55x55 cm (0.35 m³)

CODE	FINISHES			PUBLIC PRICE		
	STRUCTURE	SEAT	UPHOLSTERY			
KLTFBARROCR-1	black or white	stained	matt oak, cognac, ash, bleached oak or walnut	G1(COM/COL)	3.534 DKK	
KLTFBARROCR-2				G2	3.636 DKK	
KLTFBARROCR-3				G3	3.788 DKK	
KLTFBARROCR-4				G4	3.992 DKK	
KLTFBARROCR-5				G5	4.204 DKK	
KLTFBAR1CR-1		lacquered	white or black*	G1(COM/COL)	3.848 DKK	
KLTFBAR1CR-2					G2	3.941 DKK
KLTFBAR1CR-3					G3	4.102 DKK
KLTFBAR1CR-4					G4	4.314 DKK
KLTFBAR1CR-5					G5	4.568 DKK
KLTFBAR2CR-1			taupe, brick, ochre, olive green, dusty pink or dusty green	G1(COM/COL)	3.992 DKK	
KLTFBAR2CR-2					G2	4.102 DKK
KLTFBAR2CR-3					G3	4.254 DKK
KLTFBAR2CR-4					G4	4.526 DKK
KLTFBAR2CR-5					G5	4.721 DKK
KLTFBAR3CR-1			bronze	G1(COM/COL)	4.102 DKK	
KLTFBAR3CR-2					G2	4.204 DKK
KLTFBAR3CR-3					G3	4.356 DKK
KLTFBAR3CR-4					G4	4.610 DKK
KLTFBAR3CR-5					G5	4.822 DKK

Metal or upholstered metal armrests can be added. Accessories available.
More information on page 183

+ 4€  **Felt glides available with an upcharge of 4€. If not indicated, the stool will be produced with plastic glides.

Needed fabric for material:
1.40 m wide: 0.7 m

Stained/ Lacquered without handle and with cushion

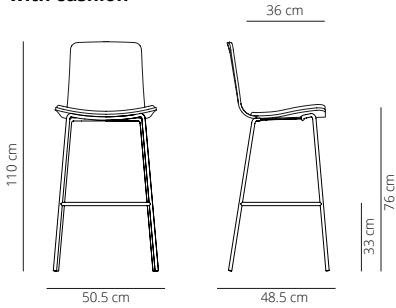

10.4 kg
(x1) 116x55x55 cm (0.35 m³)

CODE	FINISHES			PUBLIC PRICE		
	STRUCTURE	SEAT	UPHOLSTERY			
KLTFBARROC-1	black or white	stained	matt oak, cognac, ash, bleached oak or walnut	G1(COM/COL)	3.534 DKK	
KLTFBARROC-2				G2	3.636 DKK	
KLTFBARROC-3				G3	3.788 DKK	
KLTFBARROC-4				G4	3.992 DKK	
KLTFBARROC-5				G5	4.204 DKK	
KLTFBAR1C-1		lacquered	white or black*	G1(COM/COL)	G1	3.848 DKK
KLTFBAR1C-2					G2	3.941 DKK
KLTFBAR1C-3					G3	4.102 DKK
KLTFBAR1C-4					G4	4.314 DKK
KLTFBAR1C-5					G5	4.568 DKK
KLTFBAR2C-1			taupe, brick, ochre, olive green, dusty pink or dusty green	G1(COM/COL)	G1	3.992 DKK
KLTFBAR2C-2					G2	4.102 DKK
KLTFBAR2C-3					G3	4.254 DKK
KLTFBAR2C-4					G4	4.526 DKK
KLTFBAR2C-5					G5	4.721 DKK
KLTFBAR3C-1		bronze	G1(COM/COL)	G1	4.102 DKK	
KLTFBAR3C-2				G2	4.204 DKK	
KLTFBAR3C-3				G3	4.356 DKK	
KLTFBAR3C-4				G4	4.610 DKK	
KLTFBAR3C-5				G5	4.822 DKK	

*Metal or upholstered metal armrests can be added. Accessories available.
More information on page 183*

+ 4€  **Felt glides available with an upcharge of 4€. If not indicated, the stool will be produced with plastic glides.

ACCESSORIES

Metal armrest

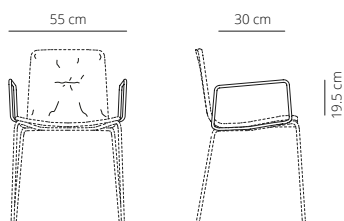

1.1 kg

Included and fitted on the chair

CODE	FINISHES	PUBLIC PRICE
KLBR	white, black or taupe	780 DKK

Calibrated steel arms powder coated in thermoreinforced polyester in black, white, taupe or fluorescent orange. Armrest available for all base and seat options.

Upholstered armrest

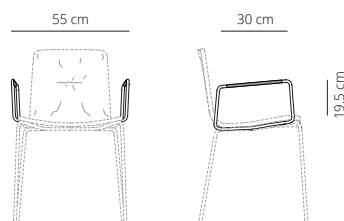

1.1 kg

Included and fitted on the chair

CODE	FINISHES		PUBLIC PRICE
	STRUCTURE	UPHOLSTERY	
KLBRTP	white, black or taupe	ecoleather	1.246 DKK
KLBRTL		leather	1.246 DKK

Calibrated steel arms powder coated in thermoreinforced polyester in black, white, taupe or fluorescent orange and upholstered in leather or ecoleather. Armrest available for all base and seat options.

Writing tablet

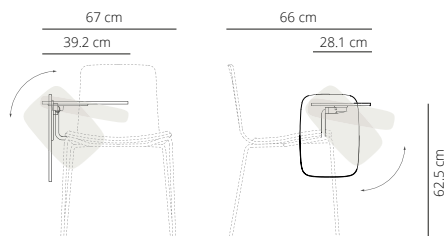

1.1 kg

Included and fitted on the chair

CODE	FINISHES	PUBLIC PRICE
KL4P-PALAD	black	881 DKK
KL4P-PALAI		881 DKK

HPL tablet with aluminum mechanism and anti-panic system. Left or right handed versions available. Available only for four metal legs base.

NOTE: Structures of the sidetable and the chair are always in the same color.

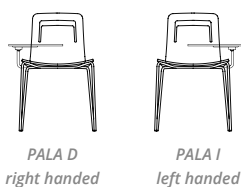

IMPORTANT INFORMATION:
The writing tablet has options for right and left handed people.
Take in count the code for each version when making the order.

Linking device for four legs chair

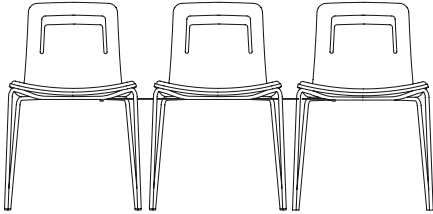

CODE	FINISHES	PUBLIC PRICE
KLUN	black	322 DKK

Linking device for chairs with four legs base. Black finish.

Trolley

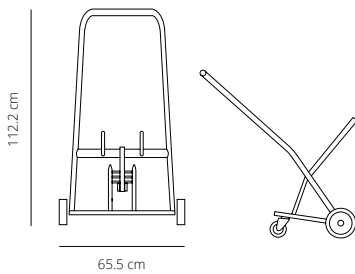

8.2 kg

(x1) 70x89x89 cm (0.55m³)

^{x10}
^{x4} The transport is possible for a maximum of 10 chairs simultaneously for models of plywood natural oak stained or lacquered and 4 chairs for upholstered models.

CODE	FINISHES	PUBLIC PRICE
KLCT	black	3.737 DKK

Used for transporting chairs with four legs base.
Trolley lacquered in black.



Last Minute

BY PATRICIA URQUIOLA

CHAIRS AND STOOLS

Test certificates: ANSI BIFMA X5.1:2012 and UNE EN 16139:13

- 1- Rotomolded polyethylene seat in black, white or taupe color or upholstered in fabric or leather.
- 2- Structure in calibrated powder coated steel in thermoreinforced polyester in black, white or taupe (taupe only available for the medium and high versions).
- 3- Footrest in stainless steel.
- 4- Black or white plastic glides or black without felt or transparent plastic glides with felt.*

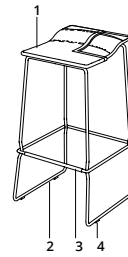

Needed fabric for material:
1.40 m wide: 0.75 m

Low stool

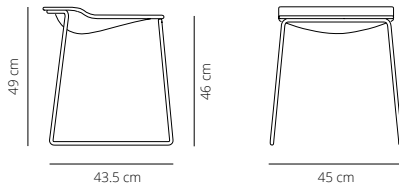

5.9 kg
(x1) 46x46x53cm (0.11 m³)

Medium stool

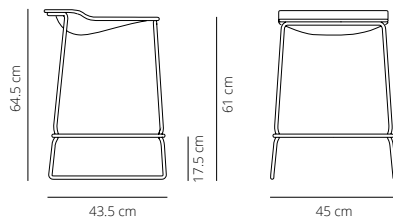

7.9 kg
(x1) 46x46x67cm (0.14 m³)

High stool

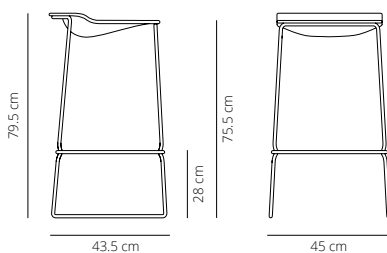

9.1 kg
(x1) 46x46x82cm (0.17 m³)

CODE	FINISHES	PUBLIC PRICE
LMB-NN	black	2.331 DKK
LMB-BB	white	
LMB-1	G1 (COM/COL)	3.271 DKK
LMB-2	G2	3.365 DKK
LMB-3	G3	3.534 DKK
LMB-4	G4	3.737 DKK
LMB-5	G5	3.898 DKK

CODE	FINISHES	PUBLIC PRICE
LMM-NN	black	2.814 DKK
LMM-BB	white	
LMM-AA	taupe	3.220 DKK
LMM-1	G1 (COM/COL)	3.737 DKK
LMM-2	G2	3.788 DKK
LMM-3	G3	3.941 DKK
LMM-4	G4	4.153 DKK
LMM-5	G5	4.314 DKK

CODE	FINISHES	PUBLIC PRICE
LMA-NN	black	2.958 DKK
LMA-BB	white	
LMA-AA	taupe	3.271 DKK
LMA-1	G1 (COM/COL)	3.898 DKK
LMA-2	G2	3.992 DKK
LMA-3	G3	4.204 DKK
LMA-4	G4	4.314 DKK
LMA-5	G5	4.526 DKK

+ 4€



*Felt glides available with an upcharge of 4€. If not indicated, the chair will be produced with plastic glides.



Zoco ^{NEW}

BY VICTOR CARRASCO

ARMCHAIRS

Zoco pays tribute to the traditional markets held in Arabic countries, central hubs of collaboration between different cultures. An environment that fuses colors, textures and scents that connect people to each other, sparking creativity, interaction, and consensus. This is what Zoco is all about, a very comfortable lounge chair with rounded shapes where work meetings, friendly encounters and the exchange of ideas revolve. Designed by Victor Carrasco.

Calibrated steel tube structure lacquered in thermoset polyester in black or white.

Upholstered cover in the fabrics and leathers of the collection, with CMHR28 fireproof foam and wadding inside.

Plastic mats with and without felt or mixed castors for hard and soft floors.

Available from 24 April 2023

FIXED LOUNGE CHAIR

Needed fabric for material
1.40 m wide: 2.4 m

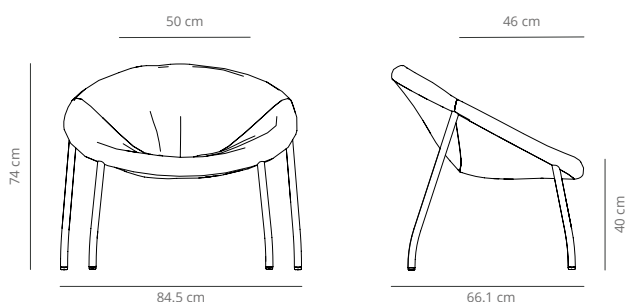

9.3 kg
(x1) 87x72x77cm (0.48m³)

CODE		FINISHED		PUBLIC PRICE
		STRUCTURE	UPHOLSTERY	
-	ZO-1	black or white	G1 (T/C)	4.916 DKK
	ZO-2		G2	5.212 DKK
	ZO-3		G3	5.975 DKK
	ZO-4		G4	6.865 DKK
	ZO-5		G5	7.543 DKK

+ 4€  *Felt glides available with an upcharge of 4€. If not indicated, the lounge chair will be produced with plastic glides.

LOUNGE CHAIR ON CASTORS

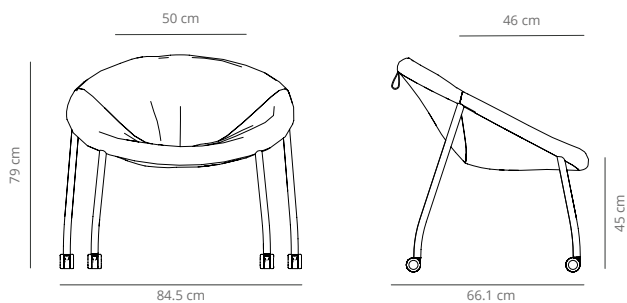

9.6 kg
(x1) 86x72x83cm (0.51m³)

CODE		FINISHED		PUBLIC PRICE
		STRUCTURE AND HANDLE	UPHOLSTERY	
-	ZOR-1	black or white	G1 (T/C)	5.017 DKK
	ZOR-2		G2	5.314 DKK
	ZOR-3		G3	6.077 DKK
	ZOR-4		G4	6.966 DKK
	ZOR-5		G5	7.644 DKK

*The girth and the frame must be of the same colour.



Funda Bold ^{NEW}

BY STEFAN DIEZ

ARMCHAIRS

Bold, suggestive and extremely comfortable. A collection of oversize seats with matching ottoman, cushions, and headrest. Funda Bold's large silhouette and comfortable proportions are created for relaxation and promoting 'slow work' in offices, homes, and in-between spaces. This design represents the new era of huge comfort. The Funda Bold lounge chair promises to be roomy without losing an ounce of lightness. Its construction system is formed by a single steel tube that makes the chair light and allows it to be easily transported.

Maintaining the sustainable philosophy of the Funda range, this design by Stefan Diez is created to last over time. Through an innovative production process, the environmental impact is minimized,

and circular economy is promoted, as both parts can be recycled independently.

Four legs base of calibrated steel tube powder coated in thermoreinforced polyester in white and black. Internal frame for the seat and back of calibrated steel tube powder coated in thermoreinforced polyester covered with shape-holding expanded polyurethane foam and polyester fibre. Fabric or leather upholstery with the finishes of our collection. Plastic glides.

BOLD LOUNGE CHAIR

Needed fabric for material 1.40 m wide:
Lounge chair: 3.8 m

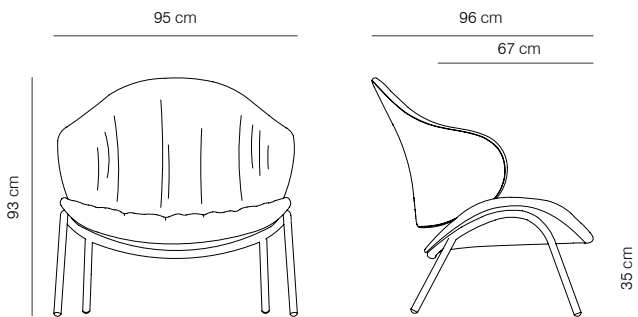

20.3 kg
(x1) 96x94x96cm (0.87m³)

CODE	FINISHES		PUBLIC PRICE
	STRUCTURE	UPHOLSTERY	
FUBO-1	black or white	G1 (T/C)	14.068 DKK
FUBO-2		G2	14.891 DKK
FUBO-3		G3	16.535 DKK
FUBO-4		G4	18.187 DKK
FUBO-5		G5	19.832 DKK

ACCESSORIES

Ottoman

Needed fabric for material 1.40 m wide:
Ottoman: 1.9 m

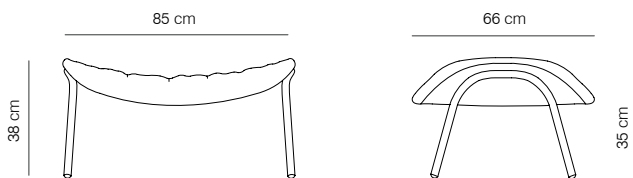

9.9 kg
(x1) 87x87x43.6cm (0.33m³)

CODE	FINISHES		PUBLIC PRICE
	STRUCTURE	UPHOLSTERY	
FUBOT-1	black or white	G1 (T/C)	5.873 DKK
FUBOT-2		G2	6.619 DKK
FUBOT-3		G3	8.102 DKK
FUBOT-4		G4	9.585 DKK
FUBOT-5		G5	11.068 DKK

Calibrated steel tube base powder coated in thermoreinforced polyester in white and black. Internal frame for the seat and back of calibrated steel tube powder coated in thermoreinforced polyester covered with shape-holding expanded polyurethane foam and polyester fibre. Fabric or leather upholstery with the finishes of our collection. Plastic glides.

Headrest

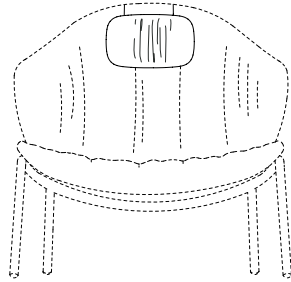
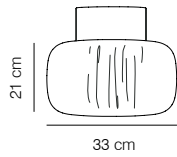

0.9 kg
(x1) 25x33x11.5 cm (0.009 m³)

Needed fabric for material
1.40 m wide:
Headrest: 0.75m
Cushion: 1m

CODE	FINISHES		PUBLIC PRICE
	UPHOLSTERY		
FUBORE-1	G1 (T/C)		1.314 DKK
FUBORE-2	G2		1.390 DKK
FUBORE-3	G3		1.780 DKK
FUBORE-4	G4		2.102 DKK
FUBORE-5	G5		2.441 DKK

Accessory that adapts perfectly to the shape of the lounge chair and the height of the user. It makes it possible to enhance comfort for situations that require prolonged sitting. Requires no installation. Available in all fabrics of our collection.

Cushion

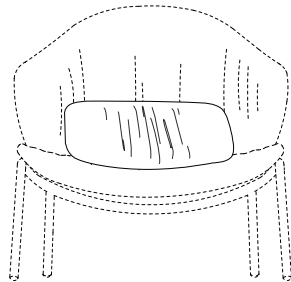
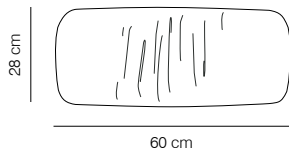

1.2 kg
(x1) 60x42x16 cm (0.04 m³)

CODE	FINISHES		PUBLIC PRICE
	UPHOLSTERY		
FUBOAL-1	G1 (T/C)		500 DKK
FUBOAL-2	G2		610 DKK
FUBOAL-3	G3		847 DKK
FUBOAL-4	G4		1.381 DKK
FUBOAL-5	G5		1.687 DKK

Cushions made of 100% siliconized high performance microfiber with anti-dust mite treatment.



Funda Lounge

BY STEFAN DIEZ

ARMCHAIRS

Test certificates: ANSI/BIFMA X5.4-2020 and UNE-EN 16139:2013vc2015

The commitment to maximum sustainability and comfort shapes Funda, a new range of seats conceived by the outstanding designer Stefan Diez under the umbrella of creating an innovative and light chair. Funda means "cover" in Spanish.

This new collection is presented as a construction made up of two differentiated pieces that, thanks to its shape, simulate the gesture or two hands which embrace the user. The development of Funda has been based on combining a metal structure designed to last over time, and an upholstered seat that can be replaced after years of use or severe wear and tear.

In this case we simplify the usual components of a chair (structure, seat, fabrics) to structure and upholstery, without losing its resistance and comfort.

Funda represents the balance between precision and the human-centered approach of Stefan Diez. His constant search for both industrial innovation and visual appeal has achieved in this collection a curved and friendly shape, combined with an upholstery known for its wrinkles.

In this way, Funda manages to evoke the maximum expression of comfort and makes available the different pieces of the range to all types of environments: restoration projects, homes, intermediate spaces and office

Needed fabric for material
1.75 m wide:
Lounge chair: 1.75 m

FOUR LEGS BASE

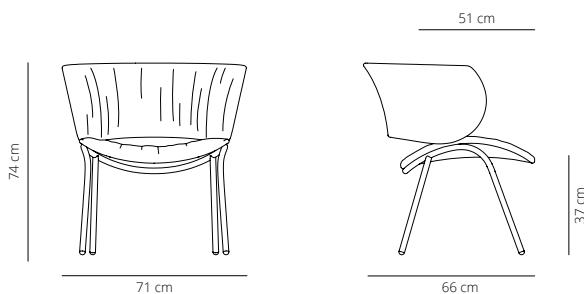

 10 kg

 (x1) 77x74x81 cm (0.46 m³)

CODE	FINISHES		PUBLIC PRICE
	STRUCTURE	UPHOLSTERY	
FUB-1	black or white	G1 (COM/COL)	6.755 DKK
FUB-2		G2	7.424 DKK
FUB-3		G3	8.043 DKK
FUB-4		G4	8.772 DKK
FUB-5		G5	9.450 DKK



Copa Lounge

BY RAMOS & BASSOLS

ARMCHAIRS

Test certificates: UNE-EN 16139:2013vc2015 and ANSI/BIFMA X5.4-2020

The comfort and rounded shapes of the Copa chair are transferred to new members of the family.

With an elegant wooden structure and with proportions and comfort as the main premises, the new lounge chair has been incorporated into the collection.

FOUR WOODEN LEGS BASE

Four solid oak wood legs stained with the finishes of our collection. Plastic glides with or without felt.*

Smooth upholstery

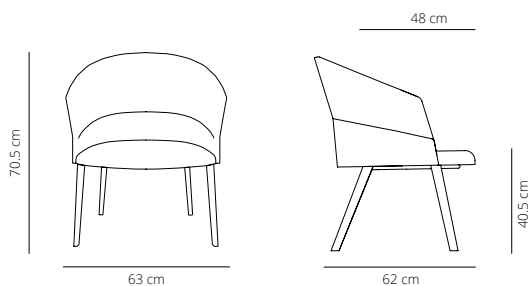

📦 10.1 kg
📦 (x1) 77x70x69 cm (0.37 m³)

Soft upholstery

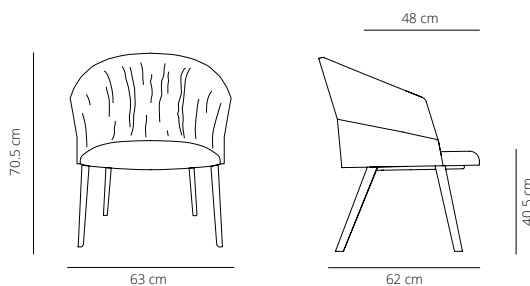

📦 10.1 kg
📦 (x1) 77x70x69 cm (0.37 m³)

Upholstery options and fabric needed

Calculated for fabric width 1.40m:

Classic upholstery	Bicolor upholstery*
Smooth upholstery: 2.1m	Seat: 1m
Soft upholstery: 2.1m	Backrest: 1.25m
Classic upholstery with leather/eco-leather backrest*	Bicolor upholstery with leather/eco-leather backrest*
Seat and backrest front: 1.6m	Seat: 1m
Backrest back: 0.7m	Backrest front: 0.65m
	Backrest back: 0.7m

*The measurings are valid for smooth and soft finishing.

CODE	FINISHES		PUBLIC PRICE
	STRUCTURE	UPHOLSTERY	
COBUMA-1	matt oak, cognac, ash, bleached oak or walnut	G1 (COM/COL)	5.602 DKK
COBUMA-2		G2	6.068 DKK
COBUMA-3		G3	6.644 DKK
COBUMA-4		G4	7.212 DKK
COBUMA-5		G5	7.890 DKK

+ 58€
+ 117€



Is possible to upholster the back part of the backrest in ecoleather for an extra of 58€ or leather for 117€. In that case, it has to be noted in the invoice with the fabric's colour reference. If not indicated, it will be upholstered with the same fabric as the seat.

CODE	FINISHES		PUBLIC PRICE
	STRUCTURE	UPHOLSTERY	
COBUMAS-1	matt oak, cognac, ash, bleached oak or walnut	G1 (COM/COL)	6.407 DKK
COBUMAS-2		G2	6.670 DKK
COBUMAS-3		G3	7.221 DKK
COBUMAS-4		G4	7.890 DKK
COBUMAS-5		G5	8.678 DKK

+ 58€
+ 117€



Is possible to upholster the back part of the backrest in ecoleather for an extra of 58€ or leather for 117€. In that case, it has to be noted in the invoice with the fabric's colour reference. If not indicated, it will be upholstered with the same fabric as the seat.

+ 4€



*Felt glides available with an upcharge of 4€. If not indicated, the chair will be produced with plastic glides.



Nagi

BY TOMOYA TABUCHI

ARMCHAIRS

Test certificates: ANSI BIFMA X5.1-2011 and UNE EN 16139:13

- 1- Internal steel tube and sheet structure with undeformable moulded Fire Retardant polyurethane foam. (Certificates CAL117 and CL 1 IM).
- 2- Fabric or leather
- 3- Inferior structure (fixed and rocking) in calibrated steel tube with brass finish or powder coated in thermoreinforced polyester, in black, white and fluorescent orange.
- 4- Nylon glides.

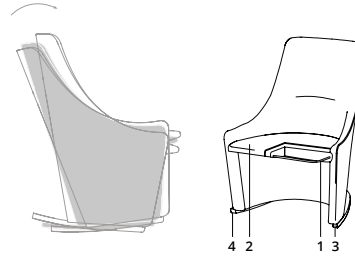

Needed fabric for material 1.40 m wide:
Smooth upholstery: 3.6m
Soft upholstery: 3.9 m

LOW BACKREST

Fixed or rocking with smooth upholstery

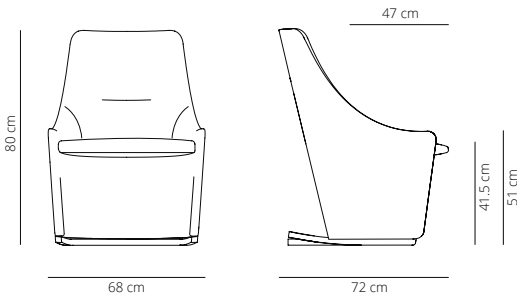

📦 21.4 kg
 📦 (x1) 75x72x86cm (0.46 m³)

CODE		FINISHES		PUBLIC PRICE
FIXED	ROCKING	FIXED OR ROCKING STRUCTURE	UPHOLSTERY	
NAGIB-1	NAGIBM-1	black or white	G1 (T/C)	10.492 DKK
NAGIB-2	NAGIBM-2		G2	11.670 DKK
NAGIB-3	NAGIBM-3		G3	12.924 DKK
NAGIB-4	NAGIBM-4		G4	14.374 DKK
NAGIB-5	NAGIBM-5		G5	15.984 DKK
NAGIB-1	NAGIBM-1	brass finish	G1 (T/C)	12.611 DKK
NAGIB-2	NAGIBM-2		G2	13.814 DKK
NAGIB-3	NAGIBM-3		G3	15.060 DKK
NAGIB-4	NAGIBM-4		G4	16.509 DKK
NAGIB-5	NAGIBM-5		G5	18.111 DKK

Fixed or rocking with soft upholstery

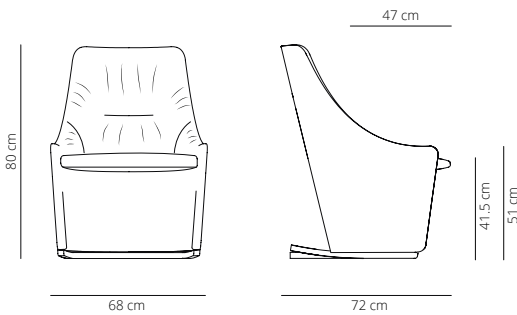

📦 21.4 kg
 📦 (x1) 75x72x86cm (0.46 m³)

CODE		FINISHES		PUBLIC PRICE
FIXED	ROCKING	FIXED OR ROCKING STRUCTURE	UPHOLSTERY	
NAGIBS-1	NAGIBMS-1	black or white	G1 (T/C)	11.526 DKK
NAGIBS-2	NAGIBMS-2		G2	12.712 DKK
NAGIBS-3	NAGIBMS-3		G3	14.009 DKK
NAGIBS-4	NAGIBMS-4		G4	15.467 DKK
NAGIBS-5	NAGIBMS-5		G5	17.069 DKK
NAGIBS-1	NAGIBMS-1	brass finish	G1 (T/C)	13.704 DKK
NAGIBS-2	NAGIBMS-2		G2	14.848 DKK
NAGIBS-3	NAGIBMS-3		G3	16.145 DKK
NAGIBS-4	NAGIBMS-4		G4	17.594 DKK
NAGIBS-5	NAGIBMS-5		G5	19.204 DKK

Nagi

2015, BY TOMOYA TABUCHI

ARMCHAIRS

Test certificates: ANSI BIFMA X5.1-2011 and UNE EN 16139:13

- 1- Internal steel tube and sheet structure with undeformable moulded Fire Retardant polyurethane foam. (Certificates CAL117 and CL 1 IM).
- 2- Fabric or leather
- 3- Inferior structure (fixed and rocking) in calibrated steel tube with brass finish or powder coated in thermoreinforced polyester, in black, white and fluorescent orange.
- 4- Nylon glides.

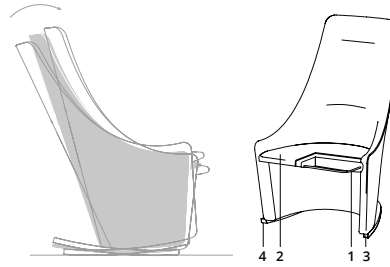

Needed fabric for material 1.40 m wide:
Smooth upholstery: 3.6 m
Soft upholstery: 3.9 m

HIGH BACKREST

Fixed or rocking with smooth upholstery

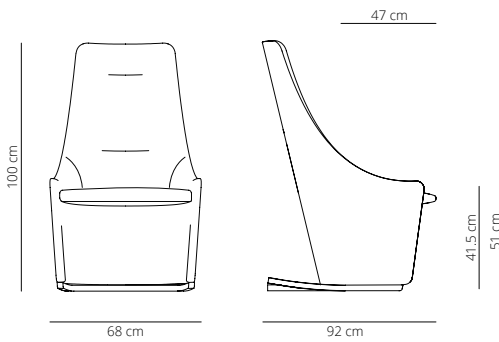

📦 25.3 kg

- 📦 (x1) 59x70x132cm (0.55 m³)
- 📦 (x1) 80x73x12cm (0.07 m³)

CODE		FINISHES		PUBLIC PRICE
FIXED	ROCKING	FIXED OR ROCKING STRUCTURE	UPHOLSTERY	
NAGI-1	NAGIM-1	black or white	G1 (T/C)	10.636 DKK
NAGI-2	NAGIM-2		G2	11.831 DKK
NAGI-3	NAGIM-3		G3	13.077 DKK
NAGI-4	NAGIM-4		G4	14.535 DKK
NAGI-5	NAGIM-5		G5	16.145 DKK
NAGI-1	NAGIM-1	brass finish	G1 (T/C)	12.772 DKK
NAGI-2	NAGIM-2		G2	13.958 DKK
NAGI-3	NAGIM-3		G3	15.263 DKK
NAGI-4	NAGIM-4		G4	16.662 DKK
NAGI-5	NAGIM-5		G5	18.272 DKK

Fixed or rocking with soft upholstery

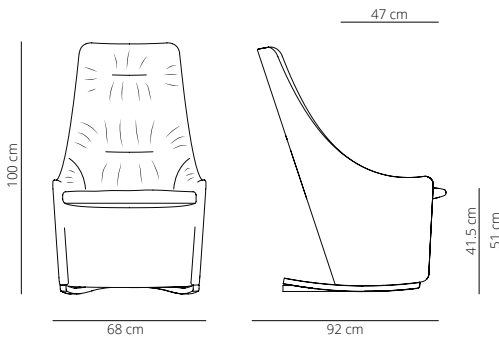

📦 25.3 kg

- 📦 (x1) 59x70x132cm (0.55 m³)
- 📦 (x1) 80x73x12cm (0.07 m³)

CODE		FINISHES		PUBLIC PRICE
FIXED	ROCKING	FIXED OR ROCKING STRUCTURE	UPHOLSTERY	
NAGIS-1	NAGIMS-1	black or white	G1 (T/C)	11.738 DKK
NAGIS-2	NAGIMS-2		G2	12.975 DKK
NAGIS-3	NAGIMS-3		G3	14.280 DKK
NAGIS-4	NAGIMS-4		G4	15.721 DKK
NAGIS-5	NAGIMS-5		G5	17.340 DKK
NAGIS-1	NAGIMS-1	brass finish	G1 (T/C)	13.857 DKK
NAGIS-2	NAGIMS-2		G2	15.102 DKK
NAGIS-3	NAGIMS-3		G3	16.399 DKK
NAGIS-4	NAGIMS-4		G4	17.848 DKK
NAGIS-5	NAGIMS-5		G5	19.467 DKK

ACCESSORIES

Needed fabric for material
1.40 m wide: 0.7 m

Headrest

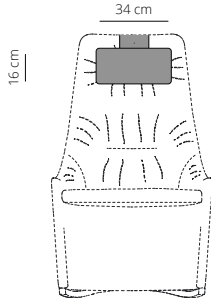

0.9 kg
(x1) 25x33x11.5 cm (0.009 m³)

CODE	FINISHES	PUBLIC PRICE
NAGIRE-1	G1 (T/C)	1.034 DKK
NAGIRE-2	G2	1.093 DKK
NAGIRE-3	G3	1.398 DKK
NAGIRE-4	G4	1.653 DKK
NAGIRE-5	G5	1.924 DKK

Accessory that adapts perfectly to the shape of the chair and the height of the user. It makes it possible to enhance comfort for situations that require prolonged sitting. Requires no installation. Available for the high chair in all fabrics of our collection.



Ace

BY JEAN-MARIE MASSAUD

ARMCHAIRS

Test certificates: ANSI BIFMA x5.1:2011 and UNE-EN 16139:13 vc 2015

- 1- Base in solid oak wood stained or lacquered beech with the finishes of our collection.
- 2- Internal frame of calibrated steel tube powder coated in thermoreinforced polyester covered with shape-holding expanded polyurethane foam.
- 3- Zip-around closure.*
- 4- Fabric or leather
- 5- Plastic glides with or without felt.**

NOTE 1: This collection offers the possibility of two-colour upholstery, with one colour for the seat and another for the back. In this case, always calculate based on the price of the fabric in the higher category.

NOTE 2: Due to the fact that the wood used is natural, the finish may vary.

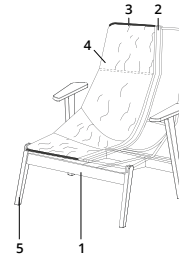

Needed fabric for material 1.40 m wide:
1 Colour: total 2.5 m
2 Colours: front 1.05 m / back 1.45 m

WOODEN BASE

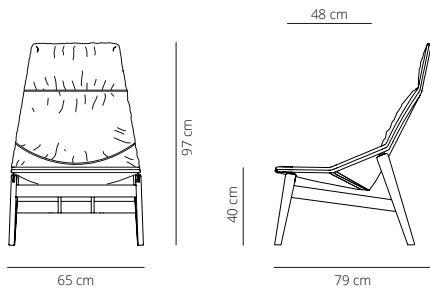

16.8 kg
 (x1) 106x79x73cm (0.61 m³)

CODE	FINISHES			PUBLIC PRICE	
	ZIPPER	BASE	UPHOLSTERY		
ACAM-1	yellow, green, red, blue and black	stained (oak)	matt oak, cognac, ash, bleached oak or walnut	G1 (T/C)	14.535 DKK
ACAM-2				G2	15.823 DKK
ACAM-3				G3	18.382 DKK
ACAM-4				G4	21.077 DKK
ACAM-5				G5	23.459 DKK

WOODEN BASE WITH ARMREST

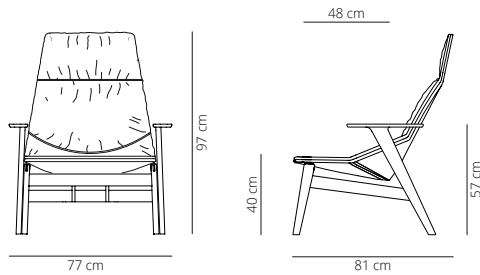

20 kg
 (x1) 107x79x83cm (0.7 m³)

CODE	FINISHES			PUBLIC PRICE	
	ZIPPER	BASE	UPHOLSTERY		
ACAMB-1	yellow, green, red, blue and black	stained (oak)	matt oak, cognac, ash, bleached oak or walnut	G1 (T/C)	16.772 DKK
ACAMB-2				G2	18.213 DKK
ACAMB-3				G3	21.171 DKK
ACAMB-4				G4	24.289 DKK
ACAMB-5				G5	26.984 DKK



Zipper not removable. Perimeter zipper available in the following colours: blue RAL 5012, green RAL 6029, red RAL 3027, yellow RAL 1016 and black RAL 9005.
 ** Felt glides available with an upcharge of 4€.
 If not indicated, the chair will be produced with plastic glides.

Ace

2007, BY JEAN-MARIE MASSAUD

ARMCHAIRS

Test certificates: ANSI/BIFMA X5.4-2012 and UNE-EN 16139:2013

- 1- Base of calibrated steel tube powder coated in thermoreinforced polyester in white and black.
- 2- Internal frame of calibrated steel tube powder coated in thermoreinforced polyester covered with shape-holding expanded polyurethane foam.
- 3- Zip-around closure.*
- 4- Fabric or leather
- 5- Black or white plastic glides or black without felt or transparent plastic glides with felt.**

NOTE: This collection offers the possibility of two-colour upholstery, with one colour for the seat and another for the back. In this case, always calculate based on the price of the fabric in the higher category.



Needed fabric for material
1.40 m wide:
1 Colour: total 2.5 m
2 Colours: front 1.05 m /
back 1.45 m

METAL BASE

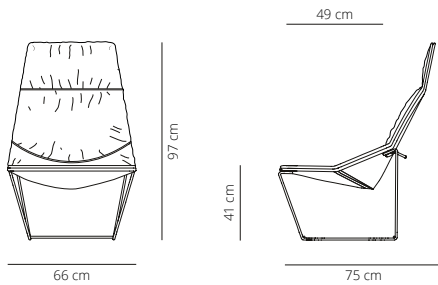

▲ 15.5 kg
📦 (x1) 79x70x106cm (0.59 m³)

CODE	FINISHES			PUBLIC PRICE
	ZIPPER	STRUCTURE	UPHOLSTERY	
ACASOFT-1	yellow, green, red, blue and black	white or black	G1 (T/C)	9.543 DKK
ACASOFT-2			G2	10.492 DKK
ACASOFT-3			G3	12.306 DKK
ACASOFT-4			G4	14.221 DKK
ACASOFT-5			G5	15.984 DKK

+ 4€

* Zipper not removable. Perimeter zipper available in the following colours: blue RAL 5012, green RAL 6029, red RAL 3027, yellow RAL 1016 and black RAL 9005.

** Felt glides available with an upcharge of 4€.

If not indicated, the chair will be produced with plastic glides.

ACCESSORIES

Headrest

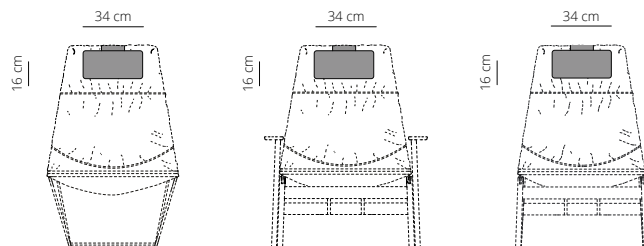

▲ 0.9 kg
📦 (x1) 25x33x11.5 cm (0.009 m³)

Needed fabric for material
1.40 m wide: 0.7 m

CODE	FINISHES	PUBLIC PRICE
ACARE-1	G1 (T/C)	1.034 DKK
ACARE-2	G2	1.093 DKK
ACARE-3	G3	1.398 DKK
ACARE-4	G4	1.653 DKK
ACARE-5	G5	1.924 DKK

Accessory that adapts perfectly to the shape of the lounge chair and the height of the user. It makes it possible to enhance comfort for situations that require prolonged sitting. Requires no installation. Available in all fabrics of our collection.

*Zipper not removable. Perimeter zipper available in the following colours: blue RAL 5012, green RAL 6029, red RAL 3027, yellow RAL 1016 and black RAL 9005.



Maarten Lounge

BY VICTOR CARRASCO

ARMCHAIRS

Needed fabric for material
1.40 m wide: 1.10 m

- 1- Calibrated steel swivel structure powder coated in thermoreinforced polyester in white, black, taupe or fluorescent orange.
- 2- Moulded shell in 3D surface veneer.
- 3- Expanded polyurethane foam.
- 4- Fabric or leather.
- 5- Transparent injection polypropylene glides.
- 6- Calibrated steel arms powder coated in thermoreinforced polyester in white, black, taupe or fluorescent orange, with natural oak armrests stained with the finishes of our collection.



SWIVEL BASE

Smooth upholstery

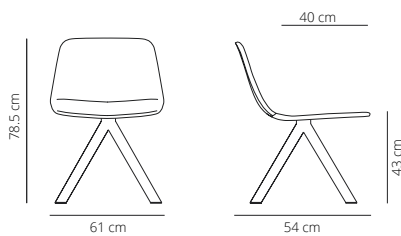

- 👤 16 kg
- 📦 (x1) 76x72x82cm (0.45 m³)

CODE	FINISHES		PUBLIC PRICE
	STRUCTURE	UPHOLSTERY	
MAALBU-1	white or black	G1 (COM/COL)	5.560 DKK
MAALBU-2		G2	6.068 DKK
MAALBU-3		G3	6.687 DKK
MAALBU-4		G4	7.373 DKK
MAALBU-5		G5	8.144 DKK

Soft upholstery

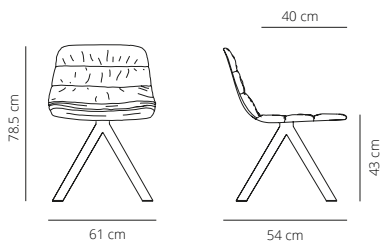

- 👤 16 kg
- 📦 (x1) 76x72x82cm (0.45 m³)

CODE	FINISHES		PUBLIC PRICE
	STRUCTURE	UPHOLSTERY	
MAABU-1	white or black	G1 (COM/COL)	5.924 DKK
MAABU-2		G2	6.483 DKK
MAABU-3		G3	7.060 DKK
MAABU-4		G4	7.738 DKK
MAABU-5		G5	8.509 DKK

Maarten Lounge

2017, BY VICTOR CARRASCO

ARMCHAIRS

- 1- Calibrated steel with an oak veneer stained with the finishes of our collection.
- 2- Moulded shell in 3D surface veneer.
- 3- Expanded polyurethane foam.
- 4- Fabric or leather.
- 5- Transparent injection polypropylene glides.
- 6- Calibrated steel arms powder coated in thermoreinforced polyester in white, black, taupe or fluorescent orange, with natural oak armrests stained with the finishes of our collection.

Needed fabric for material
1.40 m wide: 1.10 m



WOODEN SWIVEL BASE

Smooth upholstery

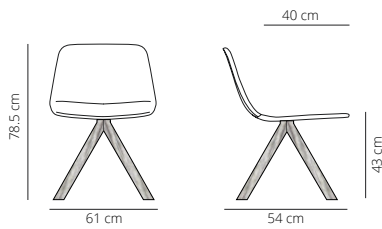

- 📦 16 kg
- 📦 (x1) 76x72x82cm (0.45 m³)

CODE	FINISHES		PUBLIC PRICE
	STRUCTURE	UPHOLSTERY	
MAALBUM-1	matt oak, cognac, ash, bleached oak or walnut	G1 (COM/COL)	7.933 DKK
MAALBUM-2		G2	8.509 DKK
MAALBUM-3		G3	9.085 DKK
MAALBUM-4		G4	9.755 DKK
MAALBUM-5		G5	10.534 DKK

Soft upholstery

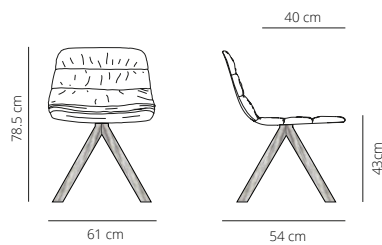

- 📦 16 kg
- 📦 (x1) 76x72x82cm (0.45 m³)

CODE	FINISHES		PUBLIC PRICE
	STRUCTURE	UPHOLSTERY	
MAABUM-1	matt oak, cognac, ash, bleached oak or walnut	G1 (COM/COL)	8.356 DKK
MAABUM-2		G2	8.882 DKK
MAABUM-3		G3	9.450 DKK
MAABUM-4		G4	10.170 DKK
MAABUM-5		G5	10.899 DKK

NOTE: Due to the fact the wood used is natural, the finish may vary.

ARMCHAIRS

AUDITORIUM BASE

Needed fabric for material
1.40 m wide: 1.10 m

Smooth upholstery

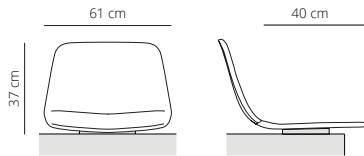

8.2 kg
(x1) 76x72x82cm (0.45 m³)*
*The package contains 2 units.

CODE	FINISHES		PUBLIC PRICE
	STRUCTURE	UPHOLSTERY	
MAALBUAU-1	grey	G1 (COM/COL)	3.788 DKK
MAALBUAU-2		G2	4.254 DKK
MAALBUAU-3		G3	4.822 DKK
MAALBUAU-4		G4	5.449 DKK
MAALBUAU-5		G5	6.136 DKK

NOTE: Price per unit
Base in calibrated powder coated steel in thermoreinforced polyester in grey, with 3D curved plywood covered by expanded polyurethane foam with smooth finish, suitable for large surfaces. Screws or anchoring system not included.

Soft upholstery

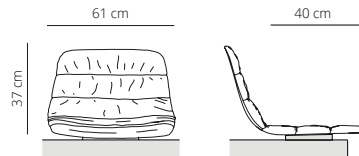

8.2 kg
(x1) 76x72x82cm (0.45 m³)*
*The package contains 2 units.

CODE	FINISHES		PUBLIC PRICE
	STRUCTURE	UPHOLSTERY	
MAABUUAU-1	grey	G1 (COM/COL)	4.153 DKK
MAABUUAU-2		G2	4.678 DKK
MAABUUAU-3		G3	5.187 DKK
MAABUUAU-4		G4	5.814 DKK
MAABUUAU-5		G5	6.543 DKK

NOTE: Price per unit
Base in calibrated powder coated steel in thermoreinforced polyester in grey, with 3D curved plywood covered by expanded polyurethane foam with a soft finish, suitable for large surfaces. Screws or anchoring system not included.

ACCESSORIES

Armrest

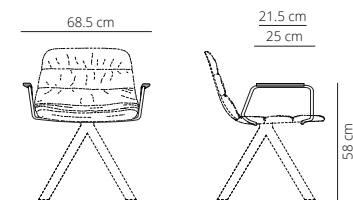

1.1 kg
Included in the box and installed on the lounge chair

CODE	FINISHES		PUBLIC PRICE
	STRUCTURE	STAIN	
MAABUB	black or white	matt oak, cognac, ash, bleached oak or walnut	1.653 DKK

NOTE: Due to the fact the wood used is natural, the finish may vary.
Calibrated steel arms powder coated in thermoreinforced polyester in white, black, taupe or fluorescent orange, with natural oak armrests stained with the finishes of our collection. Arms available for all bases and seats except from the auditorium base.



Aleta Lounge

BY JAIME HAYON

ARMCHAIRS

Test certificates: ANSI BIFMA X5.4-2012 and UNE-EN 16139:2013 vc 2015 (lounge chair without armrest)

- 1- Calibrated steel structure with brass finish or powder coated in thermoreinforcedpolyester in white, black or taupe.
- 2- Welted seat and backrest moulded in plywood covered with expanded polyuretane foam.
- 3- Fabric or leather
- 4- Black or white glides with or without felt.*

NOTE: This collection offers the possibility of two-colour upholstery, with one colour for theseat and another for the back. In this case, always calculate based on the price of the fabric in the higher category.



Needed fabric for material 1.4 m wide:
 Lounge chair:
 1 Colour: total 2.4 m
 2 Colours: seat 1.4 m / backrest 1.45 m
 Lounge chair with armrest:
 1 Colour: total 2.5 m
 2 Colours: seat 1.4 m / backrest 1.55 m

METAL BASE

Lounge chair

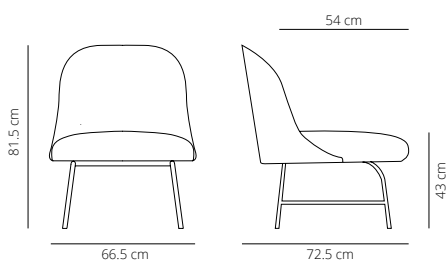

15.3 kg
 (x1) 75x72x87cm (0.47 m³)

CODE		FINISHES		PUBLIC PRICE
		STRUCTURE	UPHOLSTERY	
VCBALBUME	ALBUME-1	black, white or taupe	G1 (T/C)	8.670 DKK
	ALBUME-2		G2	9.543 DKK
	ALBUME-3		G3	11.365 DKK
	ALBUME-4		G4	12.568 DKK
	ALBUME-5		G5	13.746 DKK
	ALBUME-1	brass finish	G1 (T/C)	11.628 DKK
	ALBUME-2		G2	12.501 DKK
	ALBUME-3		G3	14.323 DKK
	ALBUME-4		G4	15.526 DKK
	ALBUME-5		G5	16.662 DKK

Lounge chair with armrest

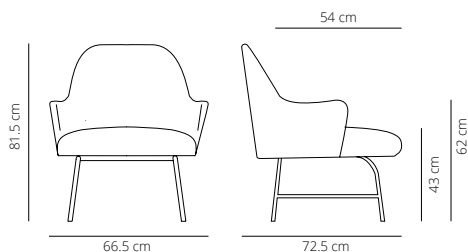

16.7 kg
 (x1) 75x72x87cm (0.47 m³)

CODE		FINISHES		PUBLIC PRICE
		STRUCTURE	UPHOLSTERY	
VCBALBUMEBR	ALBUMEBR-1	black, white or taupe	G1 (T/C)	11.111 DKK
	ALBUMEBR-2		G2	11.992 DKK
	ALBUMEBR-3		G3	13.746 DKK
	ALBUMEBR-4		G4	14.899 DKK
	ALBUMEBR-5		G5	16.094 DKK
	ALBUMEBR-1	brass finish	G1 (T/C)	14.068 DKK
	ALBUMEBR-2		G2	14.899 DKK
	ALBUMEBR-3		G3	16.662 DKK
	ALBUMEBR-4		G4	17.848 DKK
	ALBUMEBR-5		G5	19.043 DKK

+ 4€



*Felt glides available with an upcharge of 4€. If not indicated, the chair will be produced with plastic glides.

Aleta Lounge

2018, BY JAIME HAYON

ARMCHAIRS

Test certificate: UNE-EN 16139:2013 vc 2015 (lounge chair without armrest)

- 1- Base in solid oak wood stained with the finishes of our collection.
- 2- Welted seat and backrest moulded in plywood.
- 3- Expanded polyurethane foam.
- 4- Fabric or leather
- 5- Plastic glides with or without felt.*

NOTE: This collection offers the possibility of two-colour upholstery, with one colour for the seat and another for the back. In this case, always calculate based on the price of the fabric in the higher category.



Needed fabric for material 1.4 m wide:
 Lounge chair:
 1 Colour: total 2.4 m
 2 Colours: seat 1.4 m / backrest 1.45 m
 Lounge chair with armrest:
 1 Colour: total 2.5 m
 2 Colours: seat 1.4 m / backrest 1.55 m

WOODEN BASE

Lounge chair

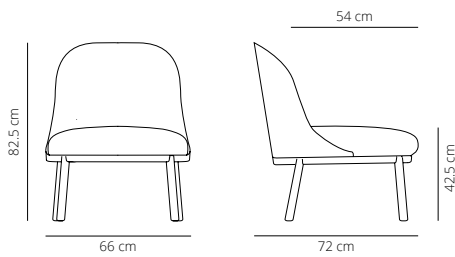

16.4 kg
 (x1) 75x72x87cm (0.47 m³)

CODE		FINISHES		PUBLIC PRICE
		STRUCTURE	UPHOLSTERY	
VCBALBUMA	ALBUMA-1	matt oak, cognac, ash, bleached oak or walnut	G1 (T/C)	11.162 DKK
	ALBUMA-2		G2	11.738 DKK
	ALBUMA-3		G3	12.823 DKK
	ALBUMA-4		G4	15.526 DKK
	ALBUMA-5		G5	16.662 DKK

Lounge chair with armrest

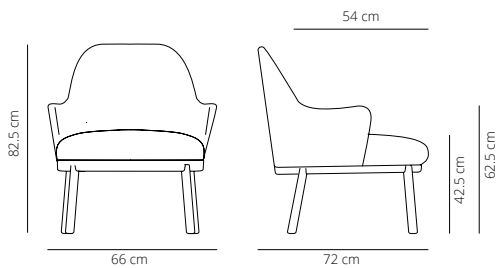

17.8 kg
 (x1) 75x72x87cm (0.47 m³)

CODE		FINISHES		PUBLIC PRICE
		STRUCTURE	UPHOLSTERY	
VCBALBUMABR	ALBUMABR-1	matt oak, cognac, ash, bleached oak or walnut	G1 (T/C)	13.746 DKK
	ALBUMABR-2		G2	14.221 DKK
	ALBUMABR-3		G3	15.204 DKK
	ALBUMABR-4		G4	17.848 DKK
	ALBUMABR-5		G5	19.043 DKK

+ 4€



*Felt glides available with an upcharge of 4€. If not indicated, the chair will be produced with plastic glides.



Brix

BY KENSAKU OSHIRO

ARMCHAIRS

Test certificates: ANSI-BIFMA X5.4:2012 and UNE EN 16139:13 (wide armrest model)

1-Interior structure of arms, back and seat in solid wood. Woven seat and back structure covered with expanded polyurethane foam in different densities. For the production of this pieces Viccarbe is using wood from certified sustainable forestry sources.

2- Polyester fibre covering.

3- Fabric or leather.

4- Structure in calibrated steel tube powder coated in thermoreinforced polyester in white or black.

5- Transparent injection polypropylene glides.

6- Auxiliary table manufactured in lacquered MDF.

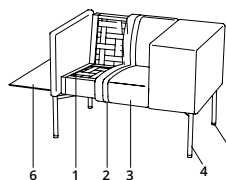

Needed fabric for material 1.40 m wide:

Brix narrow armrest: 2.3m

Brix wide armrest: 2.6m

Narrow armrest

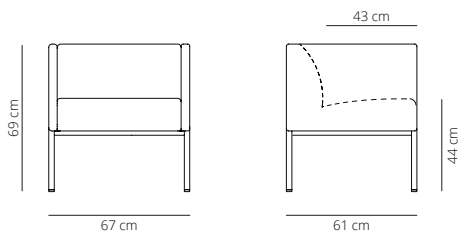

23.3 kg

(x1) 98x67x72cm (0.47 m³)

CODE	FINISHES		PUBLIC PRICE
	STRUCTURE	UPHOLSTERY	
BRIXE-1	white or black	G1 (T/C)	8.975 DKK
BRIXE-2		G2	9.712 DKK
BRIXE-3		G3	11.255 DKK
BRIXE-4		G4	13.077 DKK
BRIXE-5		G5	15.357 DKK

Wide armrest

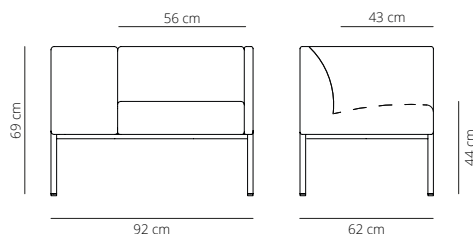

25.8 kg

(x1) 98x67x72cm (0.47 m³)

CODE		FINISHES		PUBLIC PRICE
WIDE ARM RIGHT	WIDE ARM LEFT	STRUCTURE	UPHOLSTERY	
BRIXD-1	BRIXI-1	white or black	G1 (T/C)	9.390 DKK
BRIXD-2	BRIXI-2		G2	10.221 DKK
BRIXD-3	BRIXI-3		G3	11.831 DKK
BRIXD-4	BRIXI-4		G4	13.814 DKK
BRIXD-5	BRIXI-5		G5	16.145 DKK

NOTE: The BRIX lounge chair can be served with the wide arm to the left or to the right. Indicate the desired option in the order, remembering that the name left / right is understood by looking at the element for manufacturing purposes.

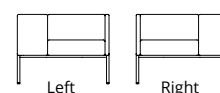

ACCESSORIES

Side table

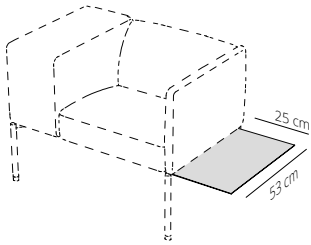

📦 2 kg

📦 (x1) 65x75x6cm (0.4 m³)

CODE	FINISHES	PUBLIC PRICE
BRIM	white or black*	1.500 DKK
	taupe, brick, ochre, olive green, dusty pink and dusty green	1.610 DKK
	bronze	1.653 DKK

The auxiliary table is manufactured in lacquered MDF in the colours of our collection and is symmetrical so it can be used on the right or the left alike. Maximum weight: 20 Kg.

NOTE 1: The table is available for both arm options.

NOTE 2: The whole range of colours has a smooth lacquered finish, except black, which has a lacquered microtextured finish.

Under seat powerbox

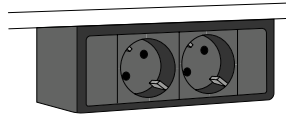

📦 1.7 kg

📦 (x1) 34X18X9cm (0.05 m³)

CODE	FINISHES	PUBLIC PRICE
BRIXEL-E	black	2.814 DKK

Powerbox under the seat with two sockets or combined with built-in multimedia devices.

Dimensions: 16.8x5.4x5.4 cm

For all available power options *see page 505*.

The cable length is 0.3 meters with Wieland connector. The power connection cable is not included, and will have to be provided by the customer.



Wrapp

BY MARC KRUSIN

ARMCHAIRS

Test certificates: UNE EN 16139:13 (swivel base), UNE EN 16139:13 vc 2015 (wooden base) and ANSI/BIFMA X5.4-2012 (all bases)

1- Internal steel tube and sheet structure covered with Fire Retardant polyurethane foam. (Certificates CAL117 and CL 1 IMF).
 2- Fabric or leather.

3- Swivel calibrated chrome steel base, four solid oak wood legs stained with the finishes of our collection or four solid oak wood legs upholstered in leather or ecoleather.

4- Plastic glides with or without felt*

NOTE: Due to the fact the wood used is natural, the finish may vary. In case of using leather, the finish may vary due to the fact that is a natural material.

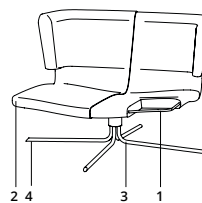

Needed fabric for material 1.40 m wide: 2.15 m

Wooden base

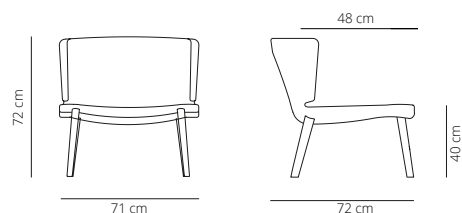

16.3 kg
 (x1) 82x72x75cm (0.44 m³)

Swivel base

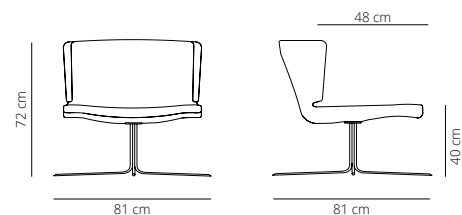

20.9 kg
 (x1) 82x72x75cm (0.44 m³)

Upholstered wooden base

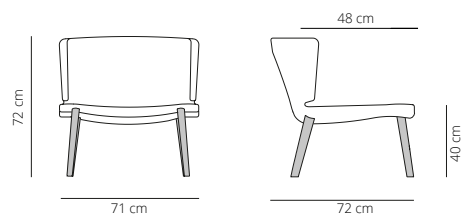

16.3 kg
 (x1) 82x72x75cm (0.44 m³)

CODE	FINISHES		PUBLIC PRICE
	STRUCTURE	UPHOLSTERY	
WRM-1	matt oak, cognac, ash, bleached oak or walnut	G1 (COM/COL)	9.348 DKK
WRM-2		G2	10.331 DKK
WRM-3		G3	11.323 DKK
WRM-4		G4	12.458 DKK
WRM-5		G5	13.704 DKK

+ 4€  *Felt glides available with an upcharge of 4€. If not indicated, the chair will be produced with plastic glides.

CODE	FINISHES		PUBLIC PRICE
	STRUCTURE	UPHOLSTERY	
WRG-1	chrome	G1 (COM/COL)	10.170 DKK
WRG-2		G2	11.162 DKK
WRG-3		G3	12.306 DKK
WRG-4		G4	13.543 DKK
WRG-5		G5	14.848 DKK

CODE	FINISHES		PUBLIC PRICE
	STRUCTURE	UPHOLSTERY	
WRTAP-1	ecoleather	G1 (COM/COL)	10.636 DKK
WRTAP-2		G2	11.628 DKK
WRTAP-3		G3	12.611 DKK
WRTAP-4		G4	13.746 DKK
WRTAP-5		G5	14.992 DKK
WRTAL-1	leather	G1 (COM/COL)	11.162 DKK
WRTAL-2		G2	12.145 DKK
WRTAL-3		G3	13.128 DKK
WRTAL-4		G4	14.280 DKK
WRTAL-5		G5	15.526 DKK

+ 4€  *Felt glides available with an upcharge of 4€. If not indicated, the chair will be produced with plastic glides.



Colubi

BY RT DESIGN

ARMCHAIRS

Test certificates: ANSI/BIFMA X5.4-2012

1- Interior structure of the back and seat in solid wood covered with expanded polyurethane foam in different densities. For the production of this pieces Viccarbe is using wood from certified sustainable forestry sources.

2- Polyester fibre covering.

3- Fabric or leather.

4- Velour.

5- Structure in calibrated powder coated steel tube in thermoreinforced polyester in white and black.

6- Natural oak armrests.

7- Anti-slip foot glides.

Needed fabric for material

1.40 m wide:

Lounge chair: 2 m

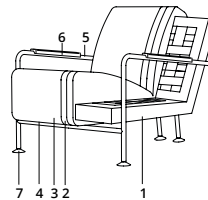

Lounge chair with metal armrest

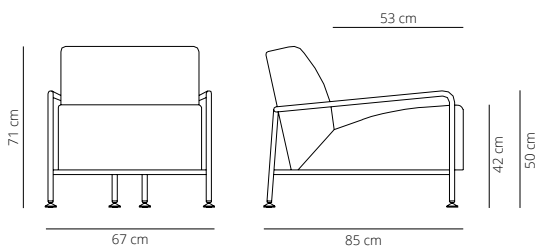

📦 17.8 kg

📦 (x1) 87x71.5x75cm (0.45 m³)

CODE	FINISHES		PUBLIC PRICE
	STRUCTURE	UPHOLSTERY	
TA04-1	white or black	G1 (T/C)	7.738 DKK
TA04-2		G2	8.509 DKK
TA04-3		G3	10.077 DKK
TA04-4		G4	11.670 DKK
TA04-5		G5	13.602 DKK

Lounge chair with wooden armrest

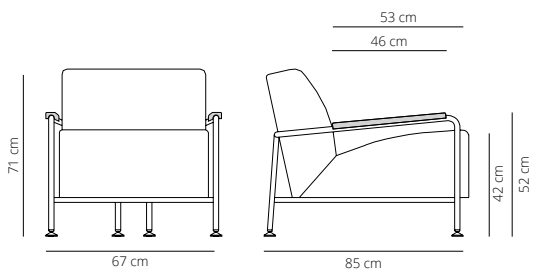

📦 18.8 kg

📦 (x1) 87x71.5x75cm (0.45 m³)

CODE	FINISHES			PUBLIC PRICE
	STRUCTURE	ARMREST	UPHOLSTERY	
TA04BR-1	white or black	matt oak, cognac, ash, bleached oak or walnut	G1 (T/C)	8.670 DKK
TA04BR-2			G2	9.450 DKK
TA04BR-3			G3	11.001 DKK
TA04BR-4			G4	12.611 DKK
TA04BR-5			G5	14.535 DKK

NOTE: Due to the fact the wood used is natural, the finish may vary.



Fedele

BY VICTOR CARRASCO

ARMCHAIRS

Test certificates: UNE EN 15373:07 and UNE EN 1728:01 (lounge chair)

- 1- Interior structure in solid wood. For the production of this pieces Viccarbe is using wood from certified sustainable forestry sources.
- 2- Expanded polyurethane foam in different densities.
- 3- Velour.
- 4- Fabric or leather.

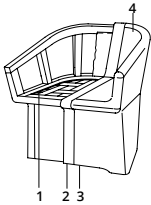

Needed fabric for material 1.40 m wide:
Pouf: 1.3 m
Lounge chair: 2.9 m

Pouf

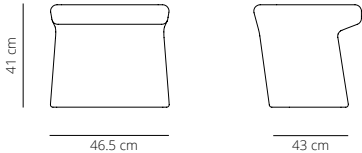

8.1 kg
 (x1) 46.5x46.5x54cm (0.12m³)

CODE	FINISHES	PUBLIC PRICE
FEP-1	G1 (COM/COL)	4.204 DKK
FEP-2	G2	4.721 DKK
FEP-3	G3	5.297 DKK
FEP-4	G4	5.924 DKK
FEP-5	G5	6.644 DKK

Lounge chair

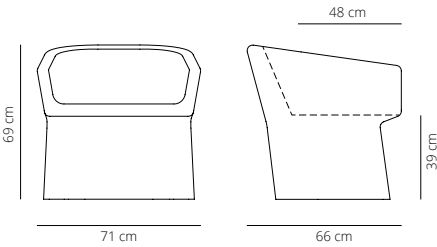

16.5 kg
 (x1) 72x72x72cm (0.37m³)

CODE	FINISHES	PUBLIC PRICE
FE-1	G1 (COM/COL)	7.424 DKK
FE-2	G2	8.356 DKK
FE-3	G3	9.348 DKK
FE-4	G4	10.492 DKK
FE-5	G5	11.780 DKK



Penta

BY TOAN NGUYEN

ARMCHAIRS

Test certificates: ANSI-BIFMA X5.4:2012 and UNE-EN 16139:2013vc2015

- 1- Internal steel tube and sheet structure covered with undeformable moulded Fire Retardant polyurethane foam. (Certificates CAL117 and CL1IM).
- 2- Fabric or leather.
- 3- Fixed or swivel base.

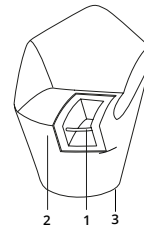

Needed fabric for material 1.40 m wide: 2.3 m

Fixed lounge chair

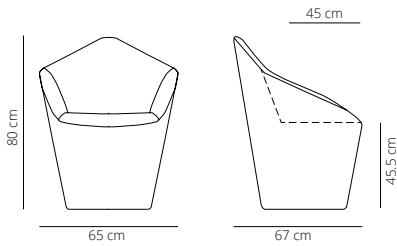

- 📦 26.1 kg
- 📦 (x1) 67x63.5x84cm (0.36 m³)

CODE	FINISHES	PUBLIC PRICE
PE-1	G1 (COM/COL)	7.424 DKK
PE-2	G2	8.356 DKK
PE-3	G3	9.348 DKK
PE-4	G4	10.492 DKK
PE-5	G5	11.780 DKK

Swivel lounge chair

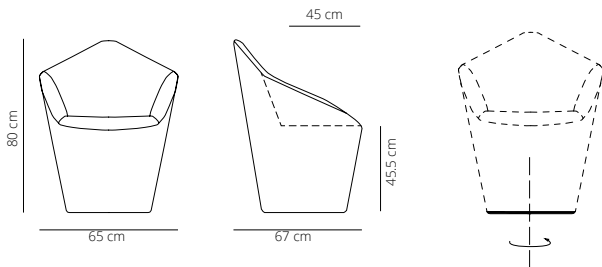

- 📦 28.5 kg
- 📦 (x1) 67x63.5x84cm (0.36 m³)

CODE	FINISHES	PUBLIC PRICE
PEG-1	G1 (COM/COL)	9.450 DKK
PEG-2	G2	10.594 DKK
PEG-3	G3	11.882 DKK
PEG-4	G4	13.289 DKK
PEG-5	G5	14.899 DKK



Savina

BY VICTOR CARRASCO

SOFAS

Savina joins our collection of ancillary furniture to enhance soft collaboration. An innovative modular cloud sofa that presents a new universe of comfortable working solutions for every office, workplace, home, hotel, or hybrid space.

The Savina collection is characterized by being a soft sofa, so the behavior of the fabric significantly influences its visual appearance depending on the selection of one fabric or another, with finer fabrics tending to generate more wrinkles than thicker fabrics. The appearance of these wrinkles is part of the original design intention. Over time and with use, wrinkles may appear on fabric, leather, or faux leather upholstered products.

NOTE: A sketch must be included with your order to avoid any sort of misunderstanding. Remember that "right" and "left" are understood from the perspective of the person looking at the object from the front. The more information you include with your order, the lower the possibility of error.

Solid wood frame with steel spring frame, non-deformable expanded polyurethane of different densities with viscoelastic layer, recycled PET fiber paneling and padded chamber filled with anti-mite feathers
Non-removable fabric or leather upholstery.
Height adjustable legs or hidden casters.

[For the production of this sofa Viccarbe is using wood from certified sustainable forestry sources]

The tolerance in the measurements of the upholstered elements can be of +/- 3 cm.

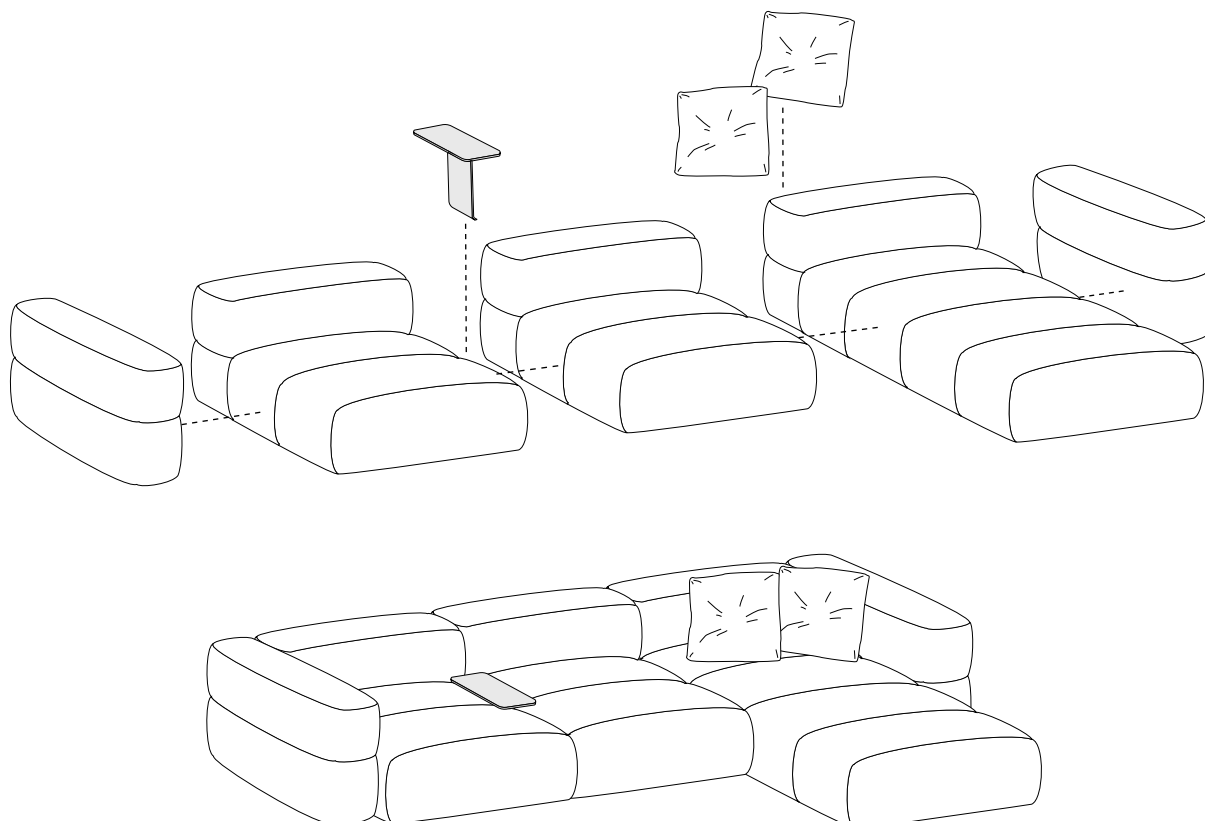
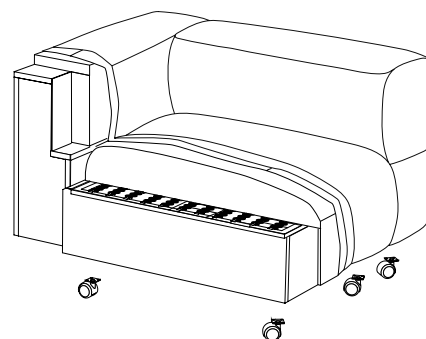
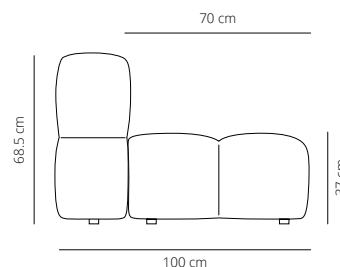

LOUNGE CHAIR SUGGESTIONS

Composition 1

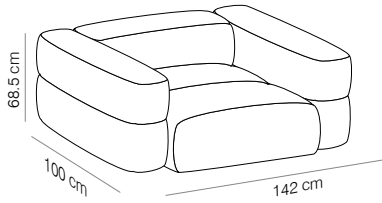

CODE	FINISHES	PUBLIC PRICE
COMPOSITION 1	G1 (T/C)	18.586 DKK
	G2	20.594 DKK
	G3	24.281 DKK
	G4	28.120 DKK
	G5	32.129 DKK

Components: 1 x SAVIM
2 x SAVIBRHT

SOFA SUGGESTIONS

Composition 2

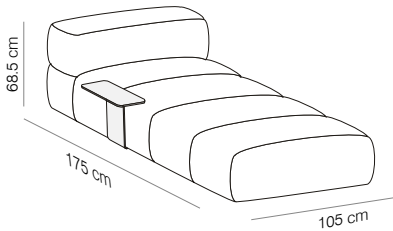

CODE	FINISHES	PUBLIC PRICE
COMPOSITION 2	G1 (T/C)	18.187 DKK
	G2	19.916 DKK
	G3	22.806 DKK
	G4	25.849 DKK
	G5	29.010 DKK

Components: 1 x SAVICH
1 x SAVIME

Composition 3

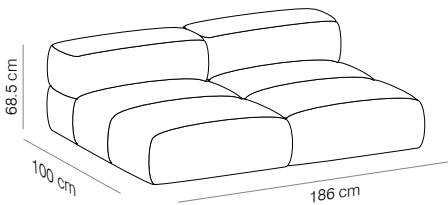

CODE	FINISHES	PUBLIC PRICE
COMPOSITION 3	G1 (T/C)	21.950 DKK
	G2	24.205 DKK
	G3	28.290 DKK
	G4	32.544 DKK
	G5	37.002 DKK

Components: 2 x SAVIM

SOFAS

Composition 4

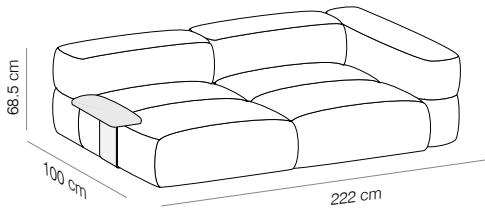

CODE	FINISHES	PUBLIC PRICE
COMPOSITION 4	G1 (T/C)	28.578 DKK
	G2	31.442 DKK
	G3	36.612 DKK
	G4	42.019 DKK
	G5	47.672 DKK

Components: 2 x SAVIM
1 x SAVIBRHT
1x SAVIBRRO

Composition 5

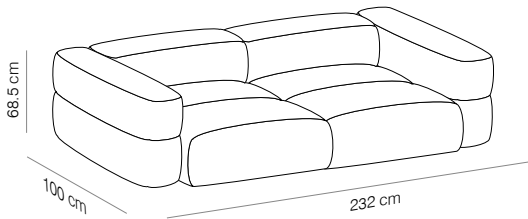

CODE	FINISHES	PUBLIC PRICE
COMPOSITION 5	G1 (T/C)	29.561 DKK
	G2	32.697 DKK
	G3	38.426 DKK
	G4	44.392 DKK
	G5	50.630 DKK

Components: 2 x SAVIM
2 x SAVIBRHT

Composition 6

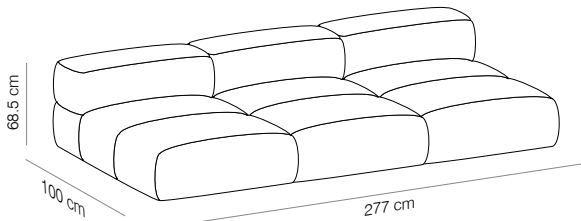

CODE	FINISHES	PUBLIC PRICE
COMPOSITION 6	G1 (T/C)	32.925 DKK
	G2	36.307 DKK
	G3	42.434 DKK
	G4	48.816 DKK
	G5	55.503 DKK

Components: 3 x SAVIM

Savina

2021, BY VICTOR CARRASCO

SOFAS

Composition 7

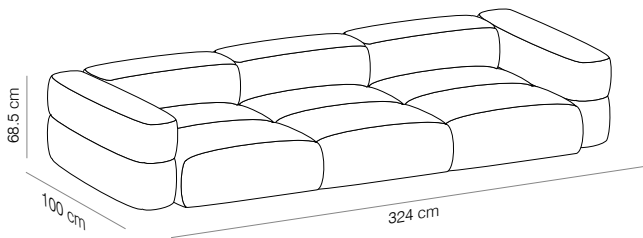

CODE	FINISHES	PUBLIC PRICE
COMPOSITION 7	G1 (T/C)	40.536 DKK
	G2	44.799 DKK
	G3	52.570 DKK
	G4	60.664 DKK
	G5	69.131 DKK

Components: 3 x SAVIM
2 x SAVIBRHT

Composition 8

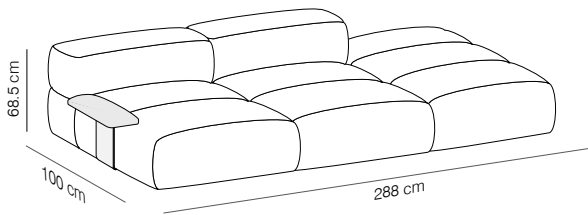

CODE	FINISHES	PUBLIC PRICE
COMPOSITION 8	G1 (T/C)	32.688 DKK
	G2	36.036 DKK
	G3	41.985 DKK
	G4	48.214 DKK
	G5	54.723 DKK

Components: 2 x SAVIM
1 x SAVISR
1 x SAVIBRRO

Composition 9

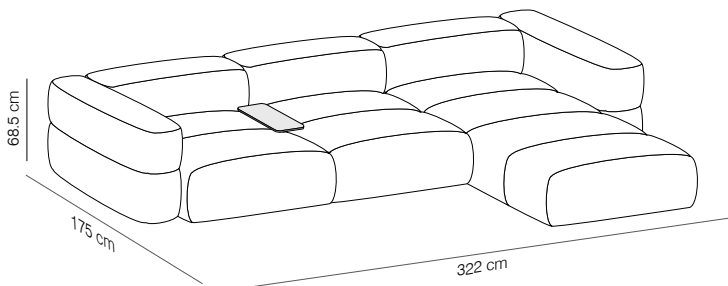

CODE	FINISHES	PUBLIC PRICE
COMPOSITION 9	G1 (T/C)	47.748 DKK
	G2	52.613 DKK
	G3	61.232 DKK
	G4	70.241 DKK
	G5	79.640 DKK

Components: 2 x SAVIM
1 x SAVICH
2 x SAVIBRHT
1 x SAVIME

SOFAS

Composition 10

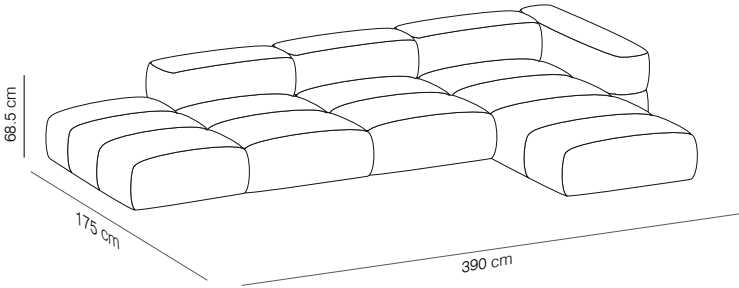

CODE	FINISHES	PUBLIC PRICE
COMPOSITION 10	G1 (T/C)	49.341 DKK
	G2	54.689 DKK
	G3	64.088 DKK
	G4	73.919 DKK
	G5	84.174 DKK

Components: 2 x SAVIM
 1 x SAVISR
 1 x SAVICH
 1 x SAVIBRHT

Composition 11

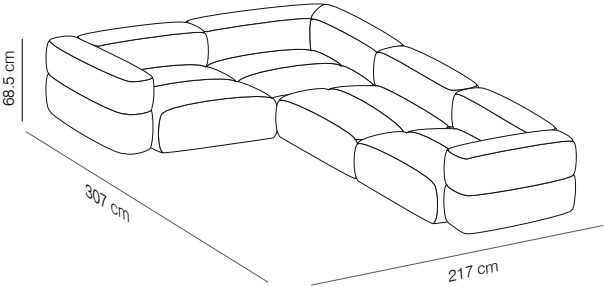

CODE	FINISHES	PUBLIC PRICE
COMPOSITION 11	G1 (T/C)	54.376 DKK
	G2	59.918 DKK
	G3	69.800 DKK
	G4	80.089 DKK
	G5	90.979 DKK

Components: 3 x SAVIM
 1 x SAVIRI
 2 x SAVIBRHT

Composition 12

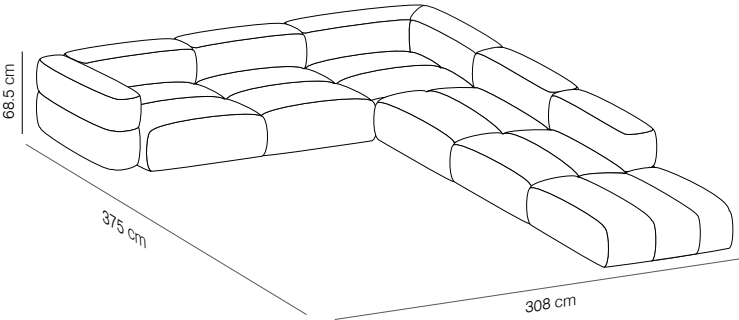

CODE	FINISHES	PUBLIC PRICE
COMPOSITION 12	G1 (T/C)	69.461 DKK
	G2	76.614 DKK
	G3	89.318 DKK
	G4	102.556 DKK
	G5	116.531 DKK

Components: 4 x SAVIM
 1 x SAVIRI
 1 x SAVISR
 1 x SAVIBRHT

Composition 13

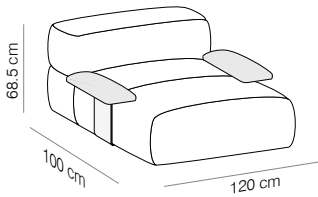

CODE	FINISHES	PUBLIC PRICE
COMPOSITION 13	G1 (T/C)	16.619 DKK
	G2	18.086 DKK
	G3	20.654 DKK
	G4	23.374 DKK
	G5	26.213 DKK

Components: 1 x SAVIM
2 x SAVIBRRO

Composition 14

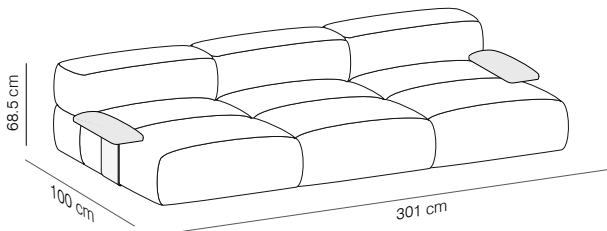

CODE	FINISHES	PUBLIC PRICE
COMPOSITION 14	G1 (T/C)	38.570 DKK
	G2	42.290 DKK
	G3	48.943 DKK
	G4	55.918 DKK
	G5	63.215 DKK

Components: 3 x SAVIM
2 x SAVIBRRO

Composition 15

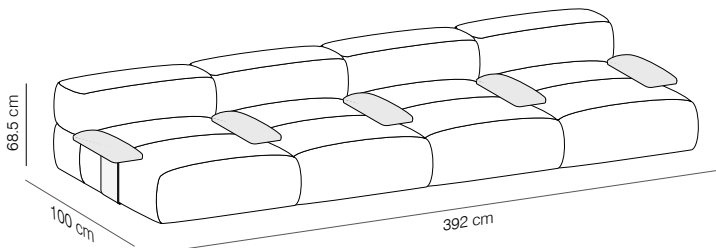

CODE	FINISHES	PUBLIC PRICE
COMPOSITION 15	G1 (T/C)	58.011 DKK
	G2	63.368 DKK
	G3	72.851 DKK
	G4	82.843 DKK
	G5	93.284 DKK

Components: 4 x SAVIM
5 x SAVIBRRO

SOFAS

Composition 16

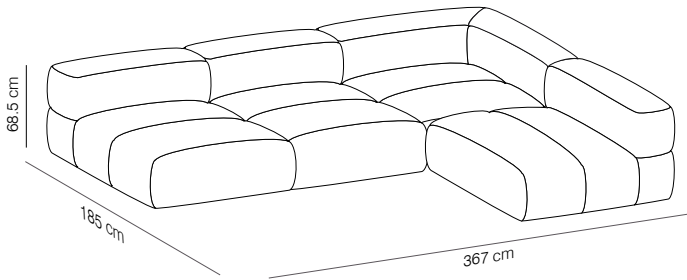

CODE	FINISHES	PUBLIC PRICE
COMPOSITION 16	G1 (T/C)	46.765 DKK
	G2	51.426 DKK
	G3	59.664 DKK
	G4	68.241 DKK
	G5	77.351 DKK

Components: 3 x SAVIM
1 x SAVIRI

Composition 17

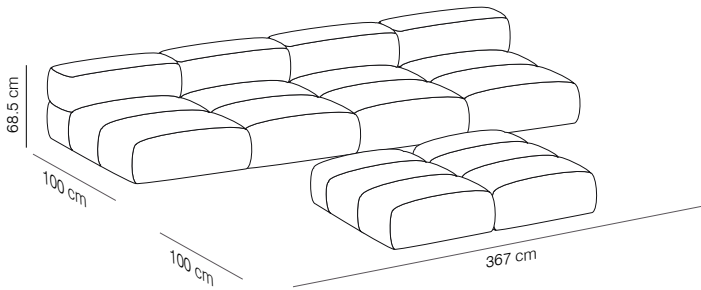

CODE	FINISHES	PUBLIC PRICE
COMPOSITION 17	G1 (T/C)	59.732 DKK
	G2	66.088 DKK
	G3	77.461 DKK
	G4	89.326 DKK
	G5	101.734 DKK

Components: 4 x SAVIM
2 x SAVIRI

Composition 18

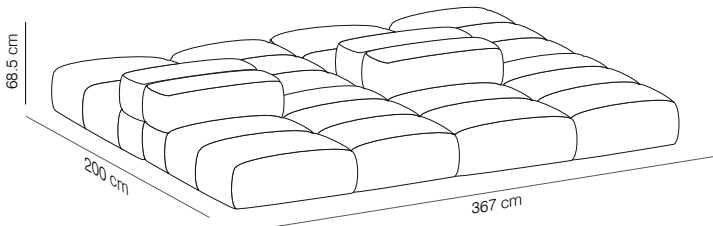

CODE	FINISHES	PUBLIC PRICE
COMPOSITION 18	G1 (T/C)	75.563 DKK
	G2	83.767 DKK
	G3	98.344 DKK
	G4	113.565 DKK
	G5	129.464 DKK

Components: 4 x SAVIM
4 x SAVIRI

SUGGESTIONS FOR SOFA WITH MODULE 140 ^{NEW}

Available as of 5 June 2023

Composition 19

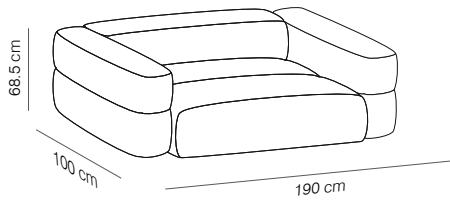

CODE	FINISHES	PUBLIC PRICE
COMPOSITION 19	G1 (T/C)	21.891 DKK
	G2	24.213 DKK
	G3	28.510 DKK
	G4	32.985 DKK
	G5	37.663 DKK

Components: 1 x SAVIMA
2 x SAVIBRHT

Composición 20

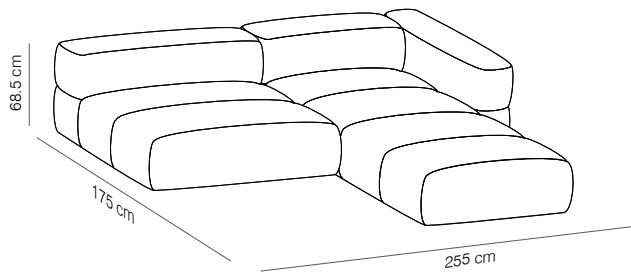

CODE	FINISHES	PUBLIC PRICE
COMPOSITION 20	G1 (T/C)	33.756 DKK
	G2	37.366 DKK
	G3	43.731 DKK
	G4	50.392 DKK
	G5	57.342 DKK

Componentes: 1 x SAVIMA
1 x SAVICH
1 x SAVIBRHT

Composición 21

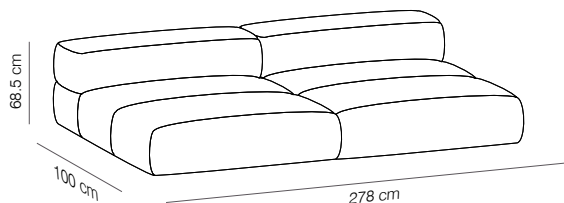

CODE	FINISHES	PUBLIC PRICE
COMPOSITION 21	G1 (T/C)	28.561 DKK
	G2	31.442 DKK
	G3	36.748 DKK
	G4	42.273 DKK
	G5	48.070 DKK

Componentes: 2 x SAVIMA

SOFAS

Composition 22

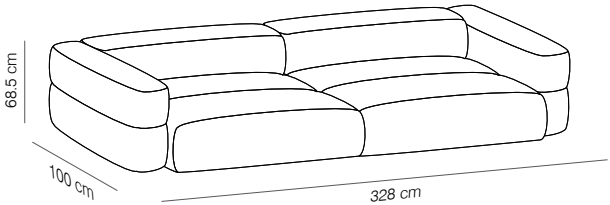

CODE	FINISHES	PUBLIC PRICE
COMPOSITION 22	G1 (T/C)	36.171 DKK
	G2	39.934 DKK
	G3	46.884 DKK
	G4	54.121 DKK
	G5	61.698 DKK

Components: 2 x SAVIMA
2 x SAVIBRHT

Composition 23

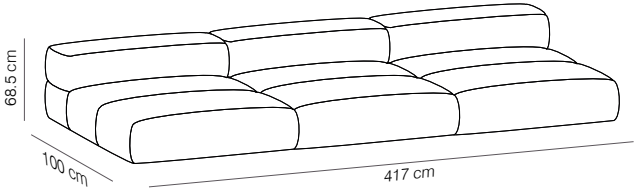

CODE	FINISHES	PUBLIC PRICE
COMPOSITION 23	G1 (T/C)	42.841 DKK
	G2	47.163 DKK
	G3	55.121 DKK
	G4	63.410 DKK
	G5	72.105 DKK

Components: 3 x SAVIMA

Composition 24

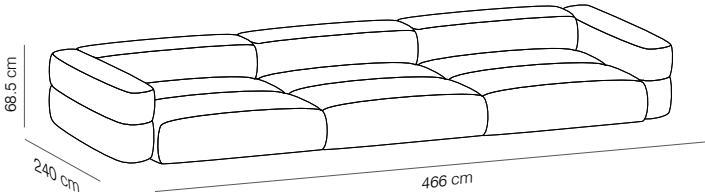

CODE	FINISHES	PUBLIC PRICE
COMPOSITION 24	G1 (T/C)	50.452 DKK
	G2	55.655 DKK
	G3	65.258 DKK
	G4	75.258 DKK
	G5	85.733 DKK

Components: 3 x SAVIMA
2 x SAVIBRHT

Savina

2021, BY VICTOR CARRASCO

SOFAS

Composition 25

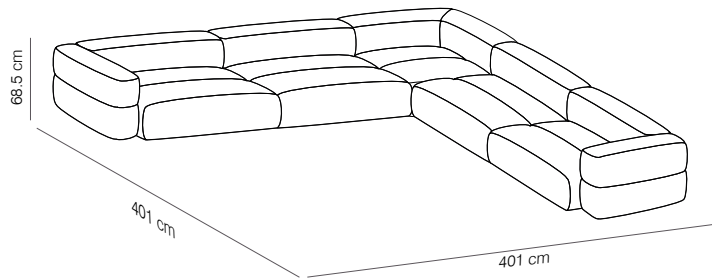

CODE	FINISHES	PUBLIC PRICE
COMPOSITION 25	G1 (T/C)	78.572 DKK
	G2	86.496 DKK
	G3	100.861 DKK
	G4	115.819 DKK
	G5	131.617 DKK

Components: 4 x SAVIMA
1 x SAVIRI
2 x SAVIBRHT

MODULE OPTIONS

Solid wood frame with steel spring frame, non-deformable expanded polyurethane of different densities with viscoelastic layer, recycled PET fiber paneling and padded chamber filled with anti-mite feathers and recycled PET fibers.

Non-removable fabric or leather upholstery.

Height adjustable legs or hidden casters.*

[For the production of this sofa Viccarbe is using wood from certified sustainable forestry sources]

Needed fabric for material
1.40 m:

Backless: 3.1 m

With backrest: 4.1 m

Backless module

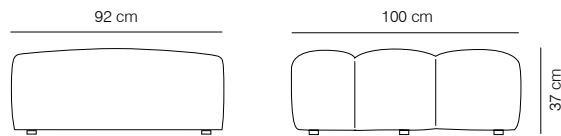

29 kg

(x1) 105x97.5x43 cm (0.44 m³)

CODE	CASTERS	FINISHES	PUBLIC PRICE
SAVISR-1	without casters	G1 (T/C)	7.916 DKK
SAVISR-2		G2	8.839 DKK
SAVISR-3		G3	10.441 DKK
SAVISR-4		G4	12.119 DKK
SAVISR-5		G5	13.865 DKK
SAVISRR-1	with casters	G1 (T/C)	8.331 DKK
SAVISRR-2		G2	9.255 DKK
SAVISRR-3		G3	10.856 DKK
SAVISRR-4		G4	12.535 DKK
SAVISRR-5		G5	14.280 DKK

Backrest module

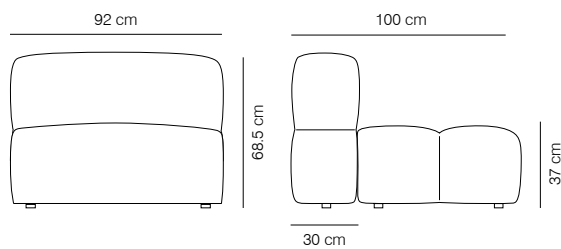

48 kg

(x1) 97x105x78 cm (0.79 m³)

CODE	CASTERS	FINISHES	PUBLIC PRICE
SAVIM-1	without casters	G1 (T/C)	10.975 DKK
SAVIM-2		G2	12.102 DKK
SAVIM-3		G3	14.145 DKK
SAVIM-4		G4	16.272 DKK
SAVIM-5		G5	18.501 DKK
SAVIMR-1	with casters	G1 (T/C)	11.416 DKK
SAVIMR-2		G2	12.551 DKK
SAVIMR-3		G3	14.594 DKK
SAVIMR-4		G4	16.713 DKK
SAVIMR-5		G5	18.942 DKK

Needed fabric for material
1.40 m:
Module 140: 4.9 m
Chaise: 5.10 m
Chaise with protection: 4.15 m
Protection: 1.95 m

Double module 140 NEW

Available from 5 June 2023

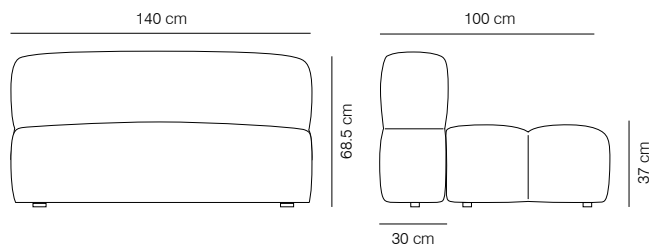

65.5 kg
(x1) 145x105x78 cm (1.2 m³)

CODE		CASTERS	FINISHES	PUBLIC PRICE
-	SAVIMA-1	without casters	G1 (T/C)	14.280 DKK
	SAVIMA-2		G2	15.721 DKK
	SAVIMA-3		G3	18.374 DKK
	SAVIMA-4		G4	21.137 DKK
	SAVIMA-5		G5	24.035 DKK
-	SAVIMAR-1	with casters	G1 (T/C)	14.662 DKK
	SAVIMAR-2		G2	16.102 DKK
	SAVIMAR-3		G3	18.755 DKK
	SAVIMAR-4		G4	21.518 DKK
	SAVIMAR-5		G5	24.416 DKK

Chaise

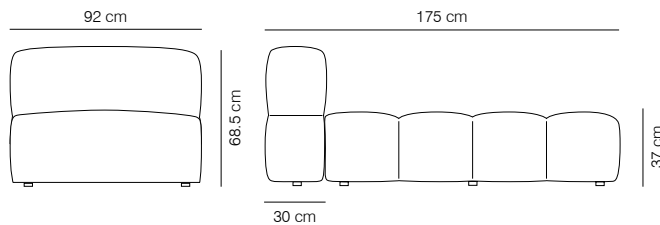

68 kg
(x1) 127x122x72 cm (1.12 m³)

CODE	CASTERS	FINISHES	PUBLIC PRICE
SAVICH-1	without casters	G1 (T/C)	15.670 DKK
SAVICH-2		G2	17.399 DKK
SAVICH-3		G3	20.289 DKK
SAVICH-4		G4	23.332 DKK
SAVICH-5		G5	26.493 DKK
SAVICHR-1	with casters	G1 (T/C)	16.111 DKK
SAVICHR-2		G2	17.840 DKK
SAVICHR-3		G3	20.738 DKK
SAVICHR-4		G4	23.772 DKK
SAVICHR-5		G5	26.934 DKK

Chaise with protection

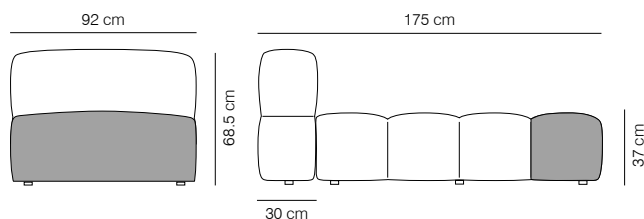

68 kg
(x1) 127x122x72 cm (1.12 m³)

CODE	CASTERS	FINISHES	PUBLIC PRICE
SAVICHP-1	without casters	G1 (T/C)	16.018 DKK
SAVICHP-2		G2	17.747 DKK
SAVICHP-3		G3	20.637 DKK
SAVICHP-4		G4	23.679 DKK
SAVICHP-5		G5	26.840 DKK
SAVICHPR-1	with casters	G1 (T/C)	16.458 DKK
SAVICHPR-2		G2	18.187 DKK
SAVICHPR-3		G3	21.086 DKK
SAVICHPR-4		G4	24.120 DKK
SAVICHPR-5		G5	27.281 DKK

Chaise in technical fabric to protect it from shoes when lying.
The technical fabric is available in light gray or dark gray.

Needed fabric for material
1.40 m:
Corner: 4.8 m

Corner

Chaise in technical fabric to protect it from shoes when lying.
The technical fabric is available in light gray or dark gray.

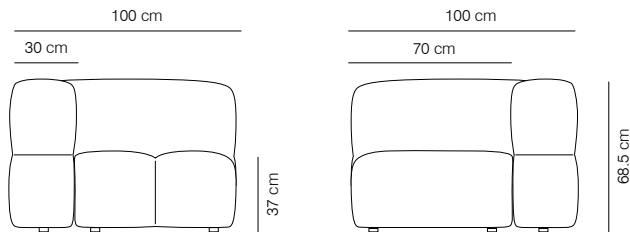

▲ 65 kg
📦 (x1) 97x105x78 cm (0.8 m³)

CODE	CASTERS	FINISHES	PUBLIC PRICE
SAVIRI-1	without casters	G1 (T/C)	13.840 DKK
SAVIRI-2		G2	15.119 DKK
SAVIRI-3		G3	17.230 DKK
SAVIRI-4		G4	19.425 DKK
SAVIRI-5		G5	21.849 DKK
SAVIRIR-1	with casters	G1 (T/C)	14.289 DKK
SAVIRIR-2		G2	15.569 DKK
SAVIRIR-3		G3	17.670 DKK
SAVIRIR-4		G4	19.874 DKK
SAVIRIR-5		G5	22.289 DKK

POUF ^{NEW}

Needed fabric for material
1.40 m:
Pouf: 3,10 m

Complementary seat without backrest, always independent of the sofa configuration.

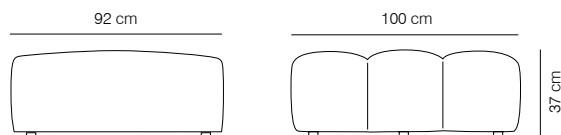

▲ 29 kg
📦 (x1) 105x97.5x43 cm (0.44 m³)

CODE	CASTERS	FINISHES	PUBLIC PRICE
-	without casters	G1 (T/C)	7.916 DKK
		G2	8.839 DKK
		G3	10.441 DKK
		G4	12.119 DKK
		G5	13.865 DKK
-	with casters	G1 (T/C)	8.331 DKK
		G2	9.255 DKK
		G3	10.856 DKK
		G4	12.535 DKK
		G5	14.280 DKK

ARMREST OPTIONS

Needed fabric for material
1.40 m:
High armrest: 2.2 m

Upholstered high armrest

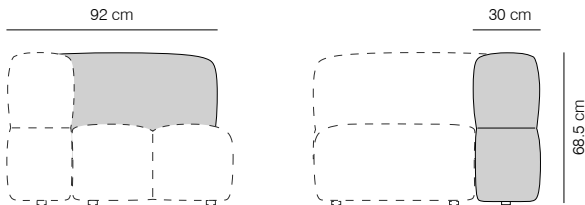

18 kg
Installed and included in the package

CODE		FINISHES	PUBLIC PRICE
RIGHT	LEFT		
SAVIBRHTD-1	SAVIBRHTI-1	G1 (T/C)	3.805 DKK
SAVIBRHTD-2	SAVIBRHTI-2	G2	4.246 DKK
SAVIBRHTD-3	SAVIBRHTI-3	G3	5.068 DKK
SAVIBRHTD-4	SAVIBRHTI-4	G4	5.924 DKK
SAVIBRHTD-5	SAVIBRHTI-5	G5	6.814 DKK

Solid wood frame, non-deformable expanded polyurethane of different densities, recycled PET fiber paneling and padded chamber filled with anti-mite feathers and recycled PET fibers.

Non-removable upholstery in fabric or leather.

[For the production of this sofa Viccarbe is using wood from certified sustainable forestry sources]

Upholstered sidearm

Needed fabric for material
1.40 m:
Sidearm: 0.5 m

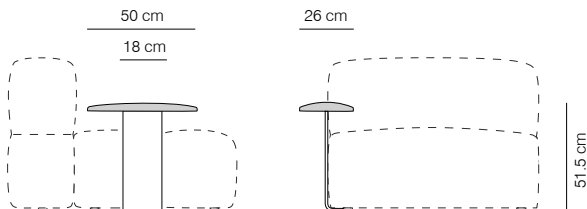

5 kg
Installed and included in the package

CODE		FINISHES		PUBLIC PRICE
RIGHT	LEFT	ARM	UPHOLSTERY	
SAVIBRROD-1	SAVIBRROI-1	matt oak, cognac, ash, bleached oak or walnut	G1 (T/C)	2.822 DKK
SAVIBRROD-2	SAVIBRROI-2		G2	2.992 DKK
SAVIBRROD-3	SAVIBRROI-3		G3	3.254 DKK
SAVIBRROD-4	SAVIBRROI-4		G4	3.551 DKK
SAVIBRROD-5	SAVIBRROI-5		G5	3.856 DKK
SAVIBRROTD-1	SAVIBRROTI-1	upholstered	G1 (T/C)	3.314 DKK
SAVIBRROTD-2	SAVIBRROTI-2		G2	3.585 DKK
SAVIBRROTD-3	SAVIBRROTI-3		G3	4.068 DKK
SAVIBRROTD-4	SAVIBRROTI-4		G4	4.543 DKK
SAVIBRROTD-5	SAVIBRROTI-5		G5	5.119 DKK

Sidearm in bent plywood and MDF board covered with non-deformable expanded polyurethane upholstered with fabrics from our collection.

ACCESSORIES

Sidetable

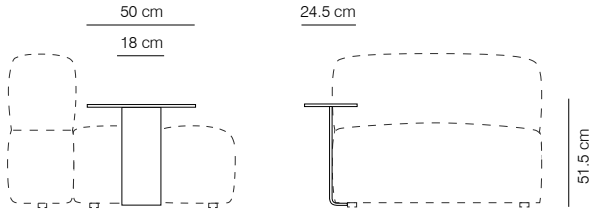

- 5 kg
- Installed and included in the package

CODE		FINISHES	PUBLIC PRICE
RIGHT	LEFT		
SAVIMED	SAVIMEI	matt oak, cognac, ash, bleached oak or walnut	2.517 DKK

Side table made of bent plywood and plywood board.

CUSHIONS

Cushions made of 100% siliconized high performance microfiber with anti-dust mite treatment.

Needed fabric for material
1.40 m wide:
Cushion 60x30: 0.35 m
Cushion 50x50: 0.55 m

Cushion 60x30

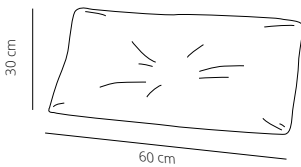

- 1.2 kg
- (x1) 60x42x16 cm (0.04 m³)

CODE	FINISHES	PUBLIC PRICE
SAVIAL30-1	G1 (T/C)	415 DKK
SAVIAL30-2	G2	525 DKK
SAVIAL30-3	G3	729 DKK
SAVIAL30-4	G4	1.195 DKK
SAVIAL30-5	G5	1.458 DKK

Cushion 50x50

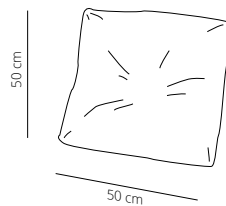

- 2 kg
- (x1) 53x53x21 cm (0.06 m³)

CODE	FINISHES	PUBLIC PRICE
SAVIAL50-1	G1 (T/C)	525 DKK
SAVIAL50-2	G2	670 DKK
SAVIAL50-3	G3	1.034 DKK
SAVIAL50-4	G4	1.610 DKK
SAVIAL50-5	G5	1.864 DKK

POWER OPTIONS

Under table powerbox

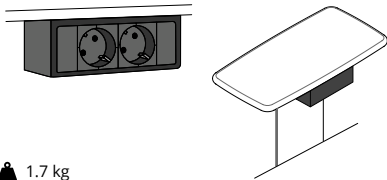

1.7 kg
 (x1) 34X18X9cm (0.05 m³)

CODE	FINISHES	PUBLIC PRICE
SAVIEL-E	black	2.814 DKK

Powerbox available with two sockets or combined with built-in multimedia devices.
Dimensions: 16.8x5.4x5.4 cm

For all available power options [see page 505](#).

The cable length is 0.3 meters with Wieland connector. The power connection cable is not included, and will have to be provided by the customer.

USB hub

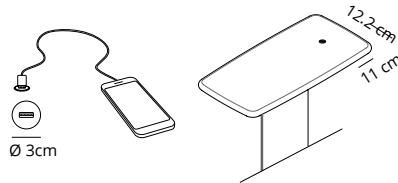

Ø 3cm

Installed and included in the package

CODE	FINISHES	PUBLIC PRICE
SAVIUSB	black or white	525 DKK

Built-in USB hub for charging electronic devices.
 Available in white or black for the sidetable in the preset positions.
 The cable length is 1.0 meter with USB connector.
Dimensions: Ø 30 mm

Seat powerbox

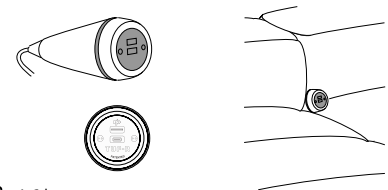

1.6 kg
 (x1) 34x18x9 cm (0.05 m³)

CODE	FINISHES	PUBLIC PRICE
SAVICON-E	black or white	1.186 DKK
SAVICON-U		2.424 DKK

Detachable free powerbox between seats.
SAVICON-E: Powerbox with one slot for socket.
SAVICON-U: Detachable free powerbox with USB - A and a USB - C.
Dimensions: Ø6.6x15 cm

For all available power options [see page 506](#).

The cable length is 0.80 m with Wieland connector. The power connection cable is not included, and will have to be provided by the customer.

Built-in SCHUKO/USB powerbox

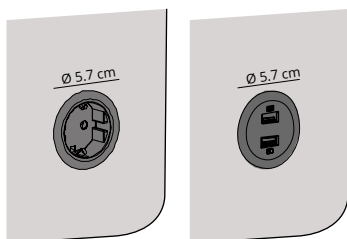

1 kg
 Included and installed in the sofa

CODE	FINISHES	PUBLIC PRICE
SAVIELE	black	831 DKK
SAVIELUA		1.144 DKK

SAVIELE: Built-in Schuko socket powerbox for device charging.
 Dimensions: Ø 5.7 cm

SAVIELUA: Built-in double USB hub for device charging.
 Dimensions: Ø 5.7 cm

The powerbox has a Wieland connector. The power connection cable is not included, and will have to be provided by the customer.

Built-in powerbox

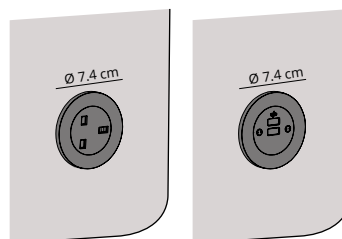

1 kg
 Included and installed in the sofa

CODE	FINISHES	PUBLIC PRICE
SAVIELO	black	1.144 DKK
SAVIELUC		2.390 DKK

SAVIELO: Built-in powerbox with multiple country socket connections available.*
 Dimensions: Ø 7.4 cm

SAVIELUC: Built-in double USB-A + USB-C hub for device charging.
 Dimensions: Ø 7.4 cm

The powerbox has a Wieland connector. The power connection cable is not included, and will have to be provided by the customer.

*For all available power options *see page 505*.

POWER OPTIONS POSITIONS

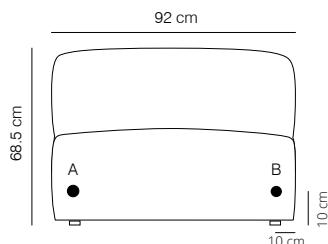

A y B are references of connection points where the electrification articles can be located, in which up to 1 article can be placed per connection point. Plug and USB options can be combined within the same piece of furniture.

As the power devices are installed inside the upholstery, a tolerance of +/-3cm respect the dimensions provided may be expected.

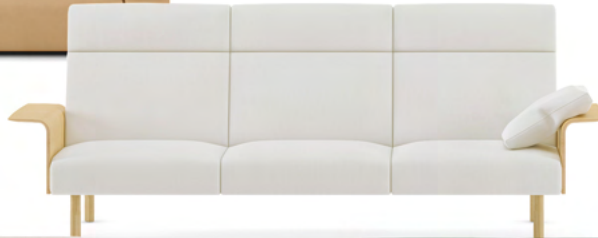

Sistema

BY LIEVORE ALTHERR MOLINA

Sistema Legs

Sistema Legs gives the possibility to choose between three different types of legs depending on the form: scissors, cylinder and flute – Offering great durability and adaptability to diverse environments.



Sistema Floor

The definitive approach to the aesthetics of a residential sofa. Perfect for an additional degree of elegance thanks to its fully upholstered modules.



Smooth Upholstery

Great durability and adaptability to diverse environments. Sistema, with its smooth upholstery, is a perfect choice for commercial spaces, offices, or airports. High traffic areas where privacy and dynamism sometimes become a sine qua non.



Soft Upholstery

A meeting point between rationalism and warmth. Soft Sistema emerges as an evolution of the Sistema sofa, presenting a more comfortable interior, as well as a more wrinkled effect in its upholstery, one that is therefore more welcoming.



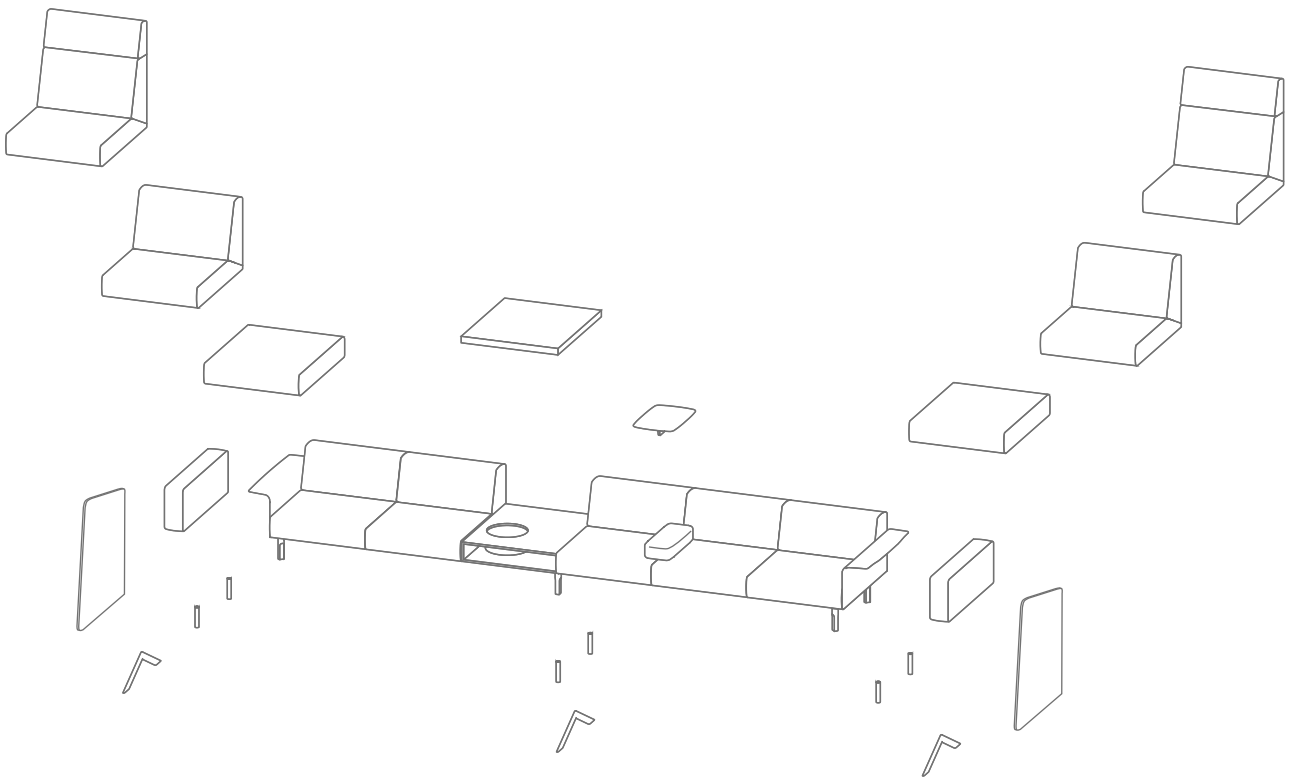



Sistema Legs

BY LIEVORE ALTHERR MOLINA

LOUNGE CHAIR SUGGESTIONS

Composition 1

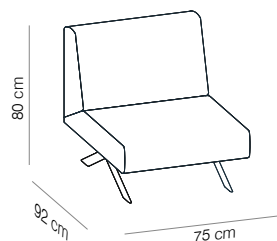

CODE	FINISHES		PUBLIC PRICE
ARMCHAIR COMPOSITION 1	smooth upholstery	G1 (T/C)	10.568 DKK
		G2	11.051 DKK
		G3	11.823 DKK
		G4	12.636 DKK
		G5	13.179 DKK
	soft upholstery	G1 (T/C)	11.628 DKK
		G2	12.111 DKK
		G3	13.111 DKK
		G4	13.984 DKK
		G5	14.899 DKK

Components: 1 x SISMBP

Composition 2

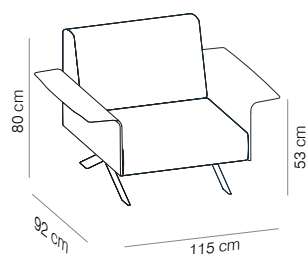

CODE	FINISHES		PUBLIC PRICE
ARMCHAIR COMPOSITION 2	smooth upholstery	G1 (T/C)	14.721 DKK
		G2	15.204 DKK
		G3	15.975 DKK
		G4	16.789 DKK
		G5	17.331 DKK
	soft upholstery	G1 (T/C)	15.780 DKK
		G2	16.264 DKK
		G3	17.264 DKK
		G4	18.136 DKK
		G5	19.052 DKK

Components: 1 x SISMBP
2 x SISBRMP

Composition 3

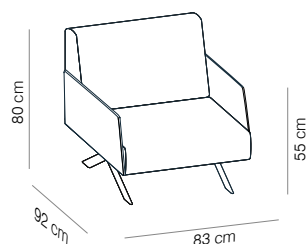

CODE	FINISHES		PUBLIC PRICE
ARMCHAIR COMPOSITION 3	smooth upholstery	G1 (T/C)	14.891 DKK
		G2	15.747 DKK
		G3	17.247 DKK
		G4	18.789 DKK
		G5	20.060 DKK
	soft upholstery	G1 (T/C)	15.950 DKK
		G2	16.806 DKK
		G3	18.535 DKK
		G4	20.137 DKK
		G5	21.781 DKK

Components: 1 x SISMBP
2 x SISBRMECP

Sistema Legs

2016, BY LIEVORE ALTHERR MOLINA

SOFAS

Composition 4

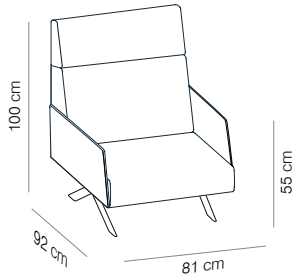

CODE	FINISHES	PUBLIC PRICE	
ARMCHAIR COMPOSITION 4	smooth upholstery	G1 (T/C)	15.272 DKK
		G2	16.187 DKK
		G3	17.992 DKK
		G4	19.798 DKK
		G5	21.628 DKK
	soft upholstery	G1 (T/C)	16.382 DKK
		G2	17.162 DKK
		G3	18.653 DKK
		G4	20.145 DKK
		G5	21.662 DKK

Components: 1 x SISABP
2 x SISBRMEP

Composition 5

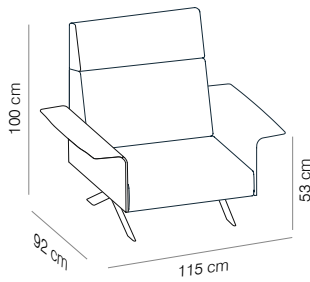

CODE	FINISHES	PUBLIC PRICE	
ARMCHAIR COMPOSITION 5	smooth upholstery	G1 (T/C)	15.441 DKK
		G2	16.153 DKK
		G3	17.569 DKK
		G4	18.984 DKK
		G5	20.408 DKK
	soft upholstery	G1 (T/C)	16.552 DKK
		G2	17.128 DKK
		G3	18.230 DKK
		G4	19.331 DKK
		G5	20.442 DKK

Components: 1 x SISABP
2 x SISBRMP

Composition 6

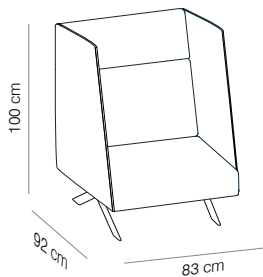

CODE	FINISHES	PUBLIC PRICE	
ARMCHAIR COMPOSITION 6	smooth upholstery	G1 (T/C)	19.086 DKK
		G2	20.713 DKK
		G3	23.281 DKK
		G4	25.849 DKK
		G5	28.527 DKK
	soft upholstery	G1 (T/C)	20.196 DKK
		G2	21.688 DKK
		G3	23.942 DKK
		G4	26.196 DKK
		G5	28.561 DKK

Components: 1 x SISABP
2 x SISBRHC

LOUNGE CHAIR CONFIGURATION ^{NEW}

- 1- Frame of calibrated steel base powder coated in thermoreinforced polyester in shadow.
- 2- Interior structure in steel, solid wood and plywood.
- 3- Woven seat and back structure.
- 4- Polyester fibre covering. Expanded polyuretane foam in different densities.
- 5- Fabric or leather.
- 6- Legs.

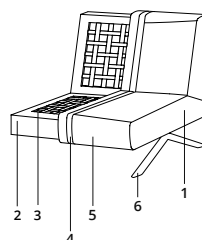

Needed fabric for material
1.40 m wide:
Medium backrest: 4.60 m
High backrest: 5.20 m

BACKREST OPTIONS

Medium backrest module with scissor legs

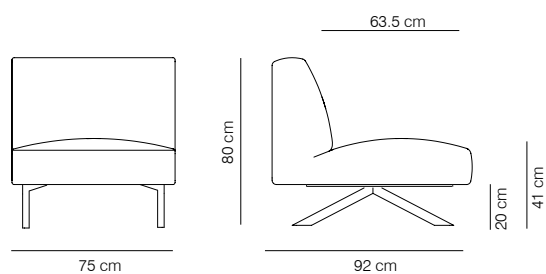

28.2 kg
7.6 kg

(x1) 66x96x80cm (0.51 m³)
(x1) 29x83x39.5cm (0.10 m³)

CODE	SCISSOR LEGS	FINISHES		PUBLIC PRICE
SISMBP-1	black or white	smooth upholstery	G1 (T/C)	10.568 DKK
SISMBP-2			G2	11.051 DKK
SISMBP-3			G3	11.823 DKK
SISMBP-4			G4	12.636 DKK
SISMBP-5			G5	13.179 DKK
SISMBPS-1		soft upholstery	G1 (T/C)	11.628 DKK
SISMBPS-2			G2	12.111 DKK
SISMBPS-3			G3	13.111 DKK
SISMBPS-4			G4	13.984 DKK
SISMBPS-5			G5	14.899 DKK

High backrest module with scissor legs

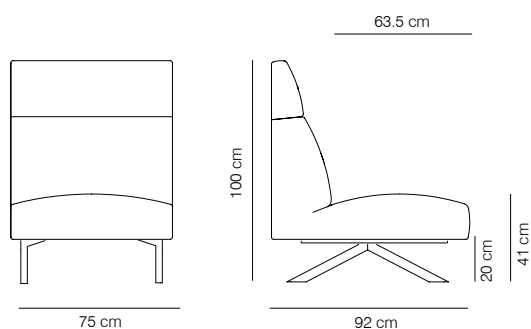

30 kg
7.6 kg

(x1) 97x80x102cm (0.51 m³)
(x1) 29x83x39.5cm (0.10 m³)

CODE	SCISSOR LEGS	FINISHES		PUBLIC PRICE
SISABP-1	black or white	smooth upholstery	G1 (T/C)	11.289 DKK
SISABP-2			G2	12.001 DKK
SISABP-3			G3	13.416 DKK
SISABP-4			G4	14.831 DKK
SISABP-5			G5	16.255 DKK
SISABPS-1		soft upholstery	G1 (T/C)	12.399 DKK
SISABPS-2			G2	12.975 DKK
SISABPS-3			G3	14.077 DKK
SISABPS-4			G4	15.179 DKK
SISABPS-5			G5	16.289 DKK

NOTA: Price includes legs

ARMREST OPTIONS

All lounge chair and sofa options may or may not have armrests. It is also possible to combine different armrests in the same composition. Please specify the armrests you have chosen in your order, choosing the corresponding code knowing that it is considered LEFT and RIGHT facing the product.

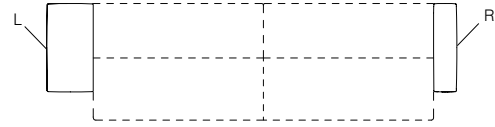

Upholstered - wooden medium armrest

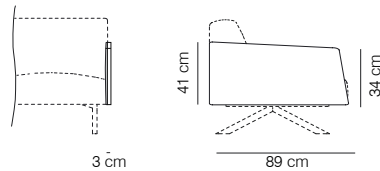

4.5 kg

Installed and included in the package

CODE		FINISHES		PUBLIC PRICE	
RIGHT	LEFT	STAINED	UPHOLSTERY		
SISBRMEPD-1	SISBRMEPI-1	matt oak, cognac, ash, bleached oak or walnut	smooth upholstery	G1 (T/C)	1.992 DKK
SISBRMEPD-2	SISBRMEPI-2			G2	2.093 DKK
SISBRMEPD-3	SISBRMEPI-3			G3	2.288 DKK
SISBRMEPD-4	SISBRMEPI-4			G4	2.483 DKK
SISBRMEPD-5	SISBRMEPI-5			G5	2.687 DKK

Needed fabric for material 1.40 m wide:
Medium wood: 0.7 m
Medium upholstered: 1.3 m

Armrest made of natural european oak plywood, stained in the finishes of our collection on the exterior, and upholstered on the interior.

Fully upholstered medium armrest

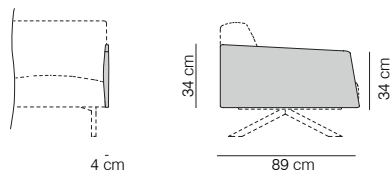

4.8 kg

Installed and included in the package

CODE		FINISHES	PUBLIC PRICE	
RIGHT	LEFT			
SISBRMECPD-1	SISBRMECPI-1	smooth upholstery	G1 (T/C)	2.161 DKK
SISBRMECPD-2	SISBRMECPI-2		G2	2.348 DKK
SISBRMECPD-3	SISBRMECPI-3		G3	2.712 DKK
SISBRMECPD-4	SISBRMECPI-4		G4	3.076 DKK
SISBRMECPD-5	SISBRMECPI-5		G5	3.441 DKK

Armrest made of natural european oak plywood upholstered on both sides.

Needed fabric for material
 1.40 m wide:
Smooth narrow armrest: 1.75 m
Soft narrow armrest: 1.45 m
Upholstered curved wood: 1.50 m

SOFAS

Upholstered narrow armrest

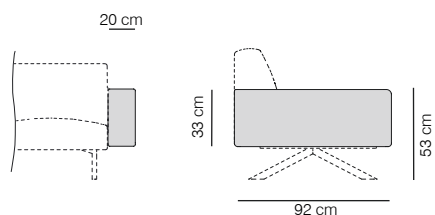

6.8 kg

Installed and included in the package

CODE		FINISHES	PUBLIC PRICE
RIGHT	LEFT		
SISBRFPD-1	SISBRFPI-1	smooth upholstery	G1 (T/C) 2.331 DKK
SISBRFPD-2	SISBRFPI-2		G2 2.856 DKK
SISBRFPD-3	SISBRFPI-3		G3 3.365 DKK
SISBRFPD-4	SISBRFPI-4		G4 3.992 DKK
SISBRFPD-5	SISBRFPI-5		G5 4.780 DKK
SISBRFPSD-1	SISBRFPSI-1	soft upholstery	G1 (T/C) 3.009 DKK
SISBRFPSD-2	SISBRFPSI-2		G2 3.475 DKK
SISBRFPSD-3	SISBRFPSI-3		G3 3.992 DKK
SISBRFPSD-4	SISBRFPSI-4		G4 4.678 DKK
SISBRFPSD-5	SISBRFPSI-5		G5 5.399 DKK

Wood structure covered with polyester fibre and non-deformable, expanded polyurethane foam of varying densities.

Curved wood or upholstered armrest

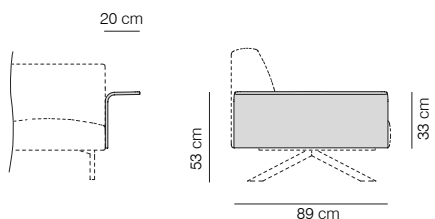

7.8 kg

Installed and included in the package

CODE		FINISHES	PUBLIC PRICE
RIGHT	LEFT		
SISBRMPD	SISBRMPI	stained matt oak, cognac, ash, bleached oak or walnut	2.076 DKK
SISBRTPD-1	SISBRTPI-1	smooth upholstery	G1 (T/C) 3.737 DKK
SISBRTPD-2	SISBRTPI-2		G2 4.153 DKK
SISBRTPD-3	SISBRTPI-3		G3 4.721 DKK
SISBRTPD-4	SISBRTPI-4		G4 5.238 DKK
SISBRTPD-5	SISBRTPI-5		G5 5.856 DKK

Curved oak plywood arm, stained with the finishes of our collection or upholstered.

NOTE: Due to the fact that the wood used is natural, the finish may vary.

Sistema Legs

2016, BY LIEVORE ALTHERR MOLINA

SOFAS

Needed fabric for material
1.40 m wide:
Upholstered-wooden: 1.50 m
Fully upholstered: 2.60 m

Upholstered-wooden high armrest

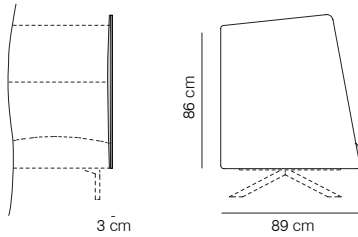

13 kg

Installed and included in the package

CODE		FINISHES		PUBLIC PRICE	
RIGHT	LEFT	STAINED	UPHOLSTERY		
SISBRHD-1	SISBRHI-1	matt oak, cognac, ash, bleached oak or walnut	smooth upholstery	G1 (T/C)	4.102 DKK
SISBRHD-2	SISBRHI-2			G2	4.610 DKK
SISBRHD-3	SISBRHI-3			G3	5.187 DKK
SISBRHD-4	SISBRHI-4			G4	5.763 DKK
SISBRHD-5	SISBRHI-5			G5	6.483 DKK

Armrest made of natural european oak plywood, stained in the finishes of our collection on the exterior, and upholstered on the interior. Only compatible with high backrest modules.

NOTE: Due to the fact that the wood used is natural, the finish may vary.

Fully upholstered high armrest

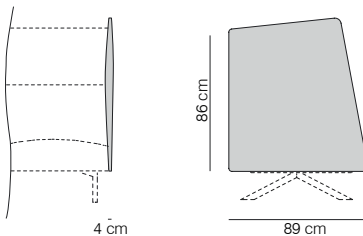

13 kg

Installed and included in the package

CODE		FINISHES		PUBLIC PRICE
RIGHT	LEFT			
SISBRHCD-1	SISBRHCI-1	smooth upholstery	G1 (T/C)	3.898 DKK
SISBRHCD-2	SISBRHCI-2		G2	4.356 DKK
SISBRHCD-3	SISBRHCI-3		G3	4.932 DKK
SISBRHCD-4	SISBRHCI-4		G4	5.509 DKK
SISBRHCD-5	SISBRHCI-5		G5	6.136 DKK

Armrest made of natural european oak plywood upholstered on both sides. Only compatible with high backrest modules.

ACCESSORIES

Needed fabric for material
1.40 m wide:
Headrest: 0.7 m

Headrest

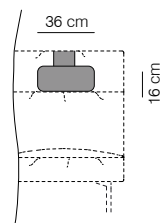

- 0.8 kg
- Installed and included in the box

CODE	FINISHES		PUBLIC PRICE
SISRE-1	upholstered	G1 (T/C)	1.034 DKK
SISRE-2		G2	1.093 DKK
SISRE-3		G3	1.398 DKK
SISRE-4		G4	1.653 DKK
SISRE-5		G5	1.924 DKK

Accessorie that adapts perfectly to the shape of the backrest, enhancing comfort in situations when prolonged rest is needed. It requires no installation and is available in all the fabrics of our collection. Only available for modules with high backrest.

CUSHIONS

Cushions made of 100% siliconized high performance microfiber with anti-dust mite treatment.

Needed fabric for material
1.40 m wide:
Cushion 60x30: 0.45 m
Cushion 50x50: 0.70 m

Cushion 60x30

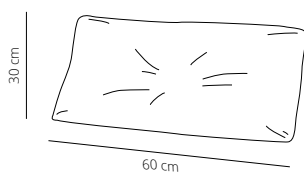

- 1.2 kg
- (x1) 60x42x16 cm (0.04 m³)

CODE	FINISHES		PUBLIC PRICE
SISAL30-1	upholstered	G1 (T/C)	415 DKK
SISAL30-2		G2	525 DKK
SISAL30-3		G3	729 DKK
SISAL30-4		G4	1.195 DKK
SISAL30-5		G5	1.458 DKK

Cushion 50x50

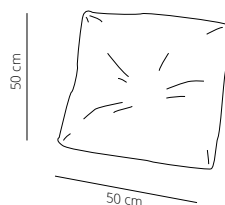

- 2 kg
- (x1) 53x53x21 cm (0.06 m³)

CODE	FINISHES		PUBLIC PRICE
SISAL50-1	upholstered	G1 (T/C)	525 DKK
SISAL50-2		G2	670 DKK
SISAL50-3		G3	1.034 DKK
SISAL50-4		G4	1.610 DKK
SISAL50-5		G5	1.864 DKK

POWER OPTIONS

Under seat powerbox

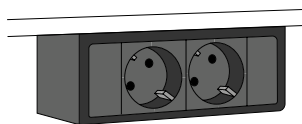

 1.7 kg

 (x1) 34X18X9cm (0.05 m³)

CODE	FINISHES	PUBLIC PRICE
SISEL-E	black	2.814 DKK

Powerbox available with two sockets or combined with built-in multimedia devices.

Dimensions: 16.8x5.4x5.4 cm

For all available power options *see page 505*.

The cable length is 0.3 meters with Wieland connector. The power connection cable is not included, and will have to be provided by the customer.

SOFA SUGGESTIONS

Composition 1

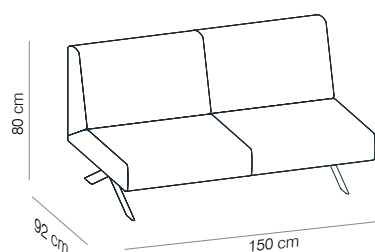

CODE	FINISHES	PUBLIC PRICE	
SOFA COMPOSITION 1	smooth upholstery	G1 (T/C)	19.086 DKK
		G2	20.137 DKK
		G3	21.798 DKK
		G4	23.560 DKK
		G5	25.222 DKK
	soft upholstery	G1 (T/C)	21.374 DKK
		G2	22.425 DKK
		G3	24.577 DKK
		G4	26.459 DKK
		G5	28.442 DKK

Components: 2 x SISMP
2 x SISPTI

Composition 1.1

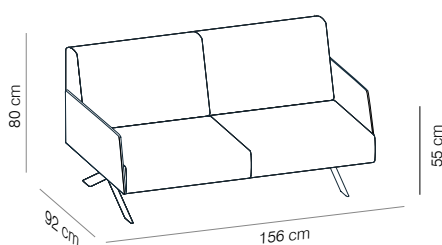

CODE	FINISHES	PUBLIC PRICE	
SOFA COMPOSITION 1.1	smooth upholstery	G1 (T/C)	23.069 DKK
		G2	24.323 DKK
		G3	26.374 DKK
		G4	28.527 DKK
		G5	30.595 DKK
	soft upholstery	G1 (T/C)	25.357 DKK
		G2	26.612 DKK
		G3	29.154 DKK
		G4	31.425 DKK
		G5	33.815 DKK

Components: 2 x SISMP
2 x SISPTI
2 x SISBRMEP

Composition 2

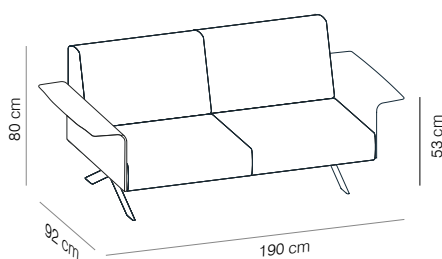

CODE	FINISHES	PUBLIC PRICE	
SOFA COMPOSITION 2	smooth upholstery	G1 (T/C)	23.238 DKK
		G2	24.289 DKK
		G3	25.950 DKK
		G4	27.713 DKK
		G5	29.374 DKK
	soft upholstery	G1 (T/C)	25.527 DKK
		G2	26.578 DKK
		G3	28.730 DKK
		G4	30.612 DKK
		G5	32.595 DKK

Components: 2 x SISMP
2 x SISPTI
2 x SISBRMP

Sistema Legs

2016, BY LIEVORE ALTHERR MOLINA

SOFAS

Composition 3

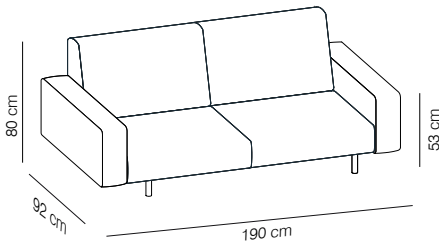

CODE	FINISHES	PUBLIC PRICE	
SOFA COMPOSITION 3	smooth upholstery	G1 (T/C)	22.086 DKK
		G2	24.188 DKK
		G3	26.866 DKK
		G4	29.883 DKK
		G5	33.120 DKK
	soft upholstery	G1 (T/C)	25.730 DKK
		G2	27.713 DKK
		G3	30.900 DKK
		G4	34.154 DKK
		G5	37.578 DKK

Components: 2 x SISMP
2 x SISPMET
2 x SISBRFP

Composition 4

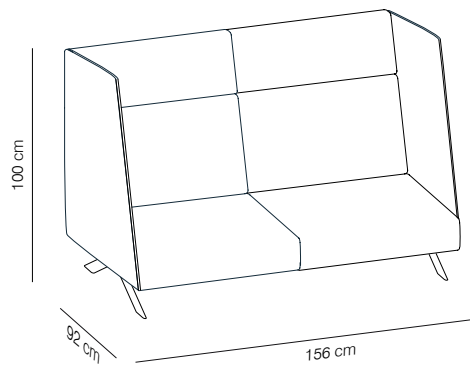

CODE	FINISHES	PUBLIC PRICE	
SOFA COMPOSITION 4	smooth upholstery	G1 (T/C)	28.849 DKK
		G2	30.798 DKK
		G3	34.137 DKK
		G4	37.256 DKK
		G5	40.765 DKK
	soft upholstery	G1 (T/C)	31.239 DKK
		G2	33.510 DKK
		G3	37.036 DKK
		G4	40.578 DKK
		G5	44.409 DKK

Components: 2 x SISAP
2 x SISPTI
2 x SISBRH

Composition 5

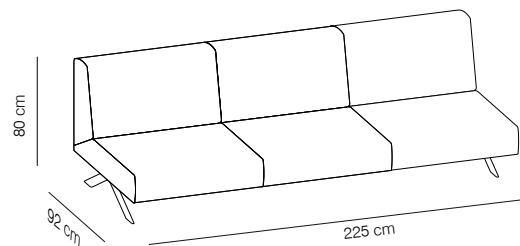

CODE	FINISHES	PUBLIC PRICE	
SOFA COMPOSITION 5	smooth upholstery	G1 (T/C)	26.764 DKK
		G2	28.340 DKK
		G3	30.832 DKK
		G4	33.476 DKK
		G5	35.968 DKK
	soft upholstery	G1 (T/C)	30.196 DKK
		G2	31.773 DKK
		G3	35.002 DKK
		G4	37.824 DKK
		G5	40.799 DKK

Components: 3 x SISMP
2 x SISPTI

SOFAS

Composition 5.1

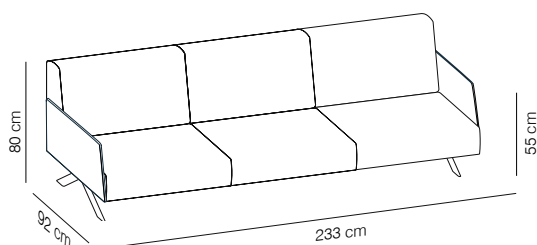

CODE	FINISHES	PUBLIC PRICE	
SOFA COMPOSITION 5.1	smooth upholstery	G1 (T/C)	31.086 DKK
		G2	33.036 DKK
		G3	36.256 DKK
		G4	39.629 DKK
		G5	42.850 DKK
	soft upholstery	G1 (T/C)	34.519 DKK
		G2	36.468 DKK
		G3	40.426 DKK
		G4	43.977 DKK
		G5	47.680 DKK

Components: 3 x SISMP
2 x SISPTI
2 x SISBRMECP

Composition 6

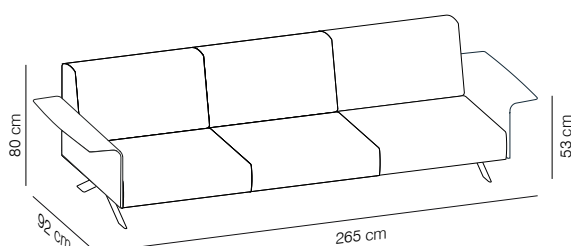

CODE	FINISHES	PUBLIC PRICE	
SOFA COMPOSITION 6	smooth upholstery	G1 (T/C)	30.917 DKK
		G2	32.493 DKK
		G3	34.985 DKK
		G4	37.629 DKK
		G5	40.121 DKK
	soft upholstery	G1 (T/C)	34.349 DKK
		G2	35.926 DKK
		G3	39.154 DKK
		G4	41.977 DKK
		G5	44.951 DKK

Components: 3 x SISMP
2 x SISPTI
2 x SISBRMP

Composition 7

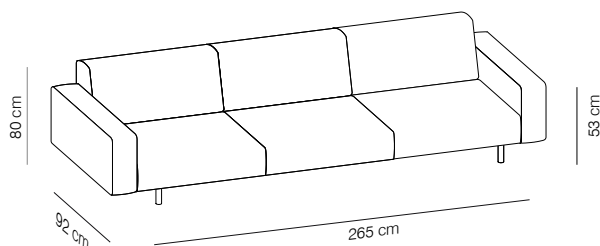

CODE	FINISHES	PUBLIC PRICE	
SOFA COMPOSITION 7	smooth upholstery	G1 (T/C)	29.764 DKK
		G2	32.391 DKK
		G3	35.900 DKK
		G4	39.799 DKK
		G5	43.867 DKK
	soft upholstery	G1 (T/C)	34.553 DKK
		G2	37.061 DKK
		G3	41.324 DKK
		G4	45.519 DKK
		G5	49.935 DKK

Components: 3 x SISMP
2 x SISPMET
2 x SISBRFP

Sistema Legs

2016, BY LIEVORE ALTHERR MOLINA

SOFAS

Composition 8

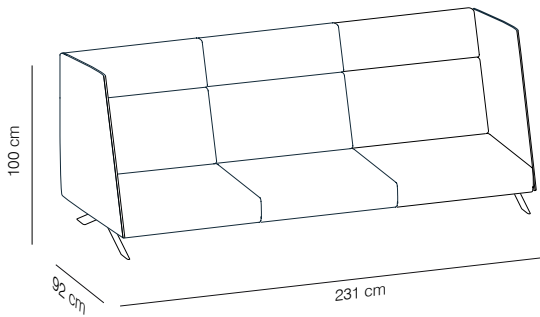

CODE	FINISHES	PUBLIC PRICE	
SOFA COMPOSITION 8	smooth upholstery	G1 (T/C)	37.307 DKK
		G2	39.722 DKK
		G3	44.155 DKK
		G4	48.257 DKK
		G5	52.799 DKK
	soft upholstery	G1 (T/C)	40.892 DKK
		G2	43.790 DKK
		G3	48.502 DKK
		G4	53.240 DKK
		G5	58.266 DKK

Components: 3 x SISAP
2 x SISPTI
2 x SISBRH

Composition 9

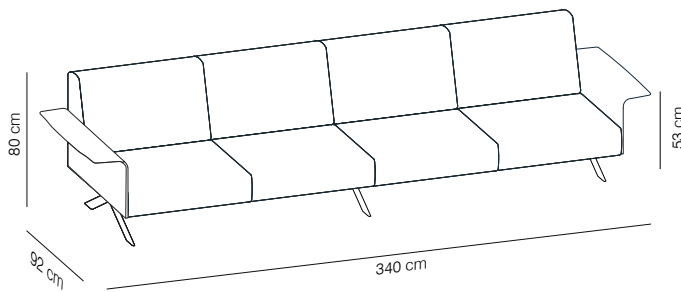

CODE	FINISHES	PUBLIC PRICE	
SOFA COMPOSITION 9	smooth upholstery	G1 (T/C)	40.460 DKK
		G2	42.561 DKK
		G3	45.884 DKK
		G4	49.409 DKK
		G5	52.731 DKK
	soft upholstery	G1 (T/C)	45.036 DKK
		G2	47.138 DKK
		G3	51.443 DKK
		G4	55.206 DKK
		G5	59.172 DKK

Components: 4 x SISPM
3 x SISPTI
2 x SISBRMP

Composition 10

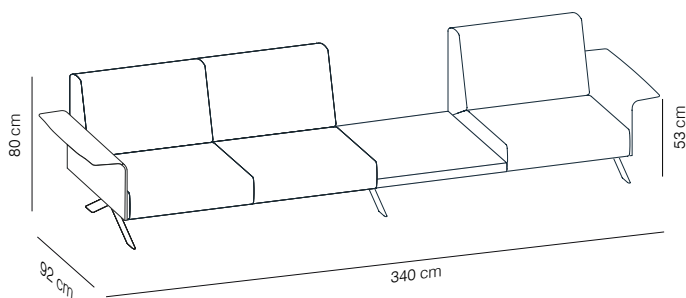

CODE	FINISHES	PUBLIC PRICE	
SOFA COMPOSITION 10	smooth upholstery	G1 (T/C)	35.951 DKK
		G2	37.527 DKK
		G3	40.019 DKK
		G4	42.663 DKK
		G5	45.155 DKK
	soft upholstery	G1 (T/C)	39.383 DKK
		G2	40.960 DKK
		G3	44.189 DKK
		G4	47.011 DKK
		G5	49.986 DKK

Components: 3 x SISMP
3 x SISPTI
1 x SISMBTX
2 x SISBRMP

NOTE: The price of the tables showed in the compositions belong to colour group 1 (Lacquered in white or black)

SOFAS

Composition 11

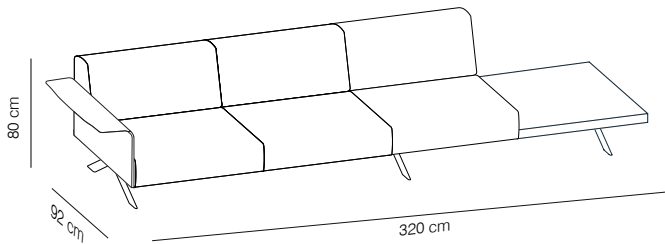

CODE	FINISHES	PUBLIC PRICE	
SOFA COMPOSITION 11	smooth upholstery	G1 (T/C)	33.875 DKK
		G2	35.451 DKK
		G3	37.943 DKK
		G4	40.587 DKK
		G5	43.078 DKK
	soft upholstery	G1 (T/C)	37.307 DKK
		G2	38.883 DKK
		G3	42.112 DKK
		G4	44.934 DKK
		G5	47.909 DKK

Components: 3 x SISMP
1 x SISBRMP
3 x SISPTI
1 x SISMBTX

Composition 12

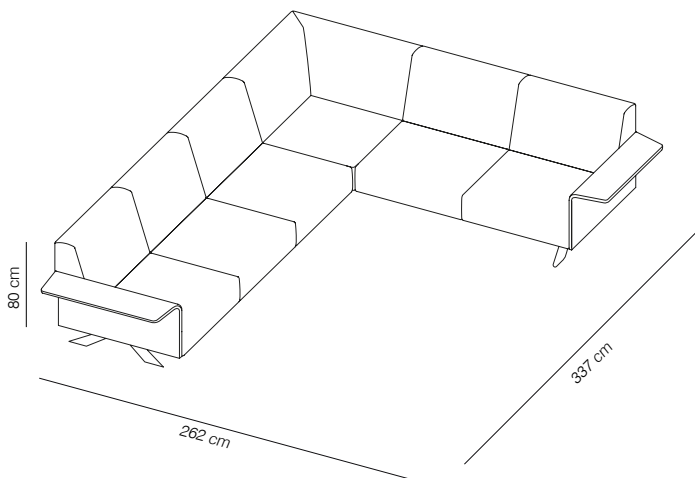

CODE	FINISHES	PUBLIC PRICE	
SOFA COMPOSITION 12	smooth upholstery	G1 (T/C)	61.325 DKK
		G2	64.664 DKK
		G3	70.275 DKK
		G4	75.978 DKK
		G5	81.538 DKK
	soft upholstery	G1 (T/C)	68.749 DKK
		G2	72.207 DKK
		G3	79.199 DKK
		G4	85.504 DKK
		G5	92.030 DKK

Components: 5 x SISMP
1 x SISRIP
4 x SISPTI
2 x SISBRTP

Nota: Los precios de las mesas en las composiciones que se muestran pertenecen al grupo de colores 1 (lacado en blanco o negro).

Sistema Legs

2016, BY LIEVORE ALTHERR MOLINA

SOFAS

Composition 13

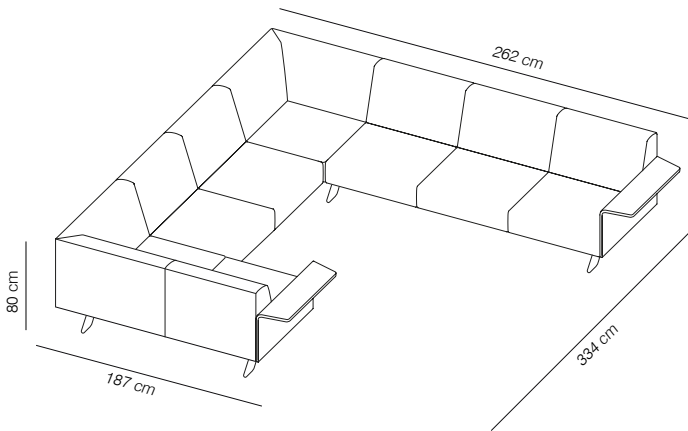

CODE	FINISHES	PUBLIC PRICE	
SOFA COMPOSITION 13	smooth upholstery	G1 (T/C)	84.055 DKK
		G2	88.632 DKK
		G3	96.530 DKK
		G4	104.412 DKK
		G5	112.209 DKK
	soft upholstery	G1 (T/C)	94.327 DKK
		G2	99.141 DKK
		G3	108.819 DKK
		G4	117.667 DKK
		G5	126.752 DKK

Components: 6 x SISMP
2 x SISRIP
6 x SISPTI
2 x SISBRTP

Composition 14

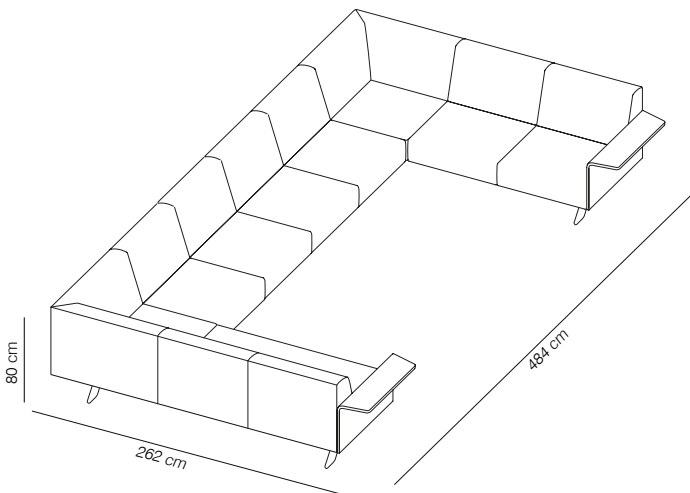

CODE	FINISHES	PUBLIC PRICE	
SOFA COMPOSITION 14	smooth upholstery	G1 (T/C)	101.276 DKK
		G2	106.904 DKK
		G3	116.463 DKK
		G4	126.108 DKK
		G5	135.566 DKK
	soft upholstery	G1 (T/C)	113.836 DKK
		G2	119.701 DKK
		G3	131.532 DKK
		G4	142.261 DKK
		G5	153.330 DKK

Components: 8 x SISMP
2 x SISRIP
7 x SISPTI
2 x SISBRTP

SOFA CONFIGURATION

Test certificates: ANSI/BIFMA X5.4-2012 y UNE EN 16139:2013

- 1- Frame of calibrated steel base powder coated in thermoreinforced polyester in shadow.
- 2- Interior structure in steel, solid wood and plywood.
- 3- Woven seat and back structure.
- 4- Polyester fibre covering. Expanded polyuretane foam in different densities.
- 5- Fabric or leather.
- 6- Legs.

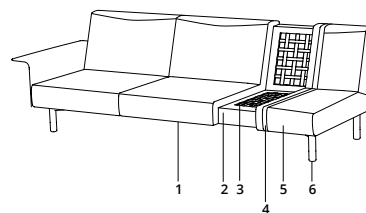

Needed fabric for material 1.40 m wide:
Smooth backless: 2.90 m
Soft backless: 2.90 m
Medium backrest: 3.1 m

BACKREST OPTIONS

Backless module

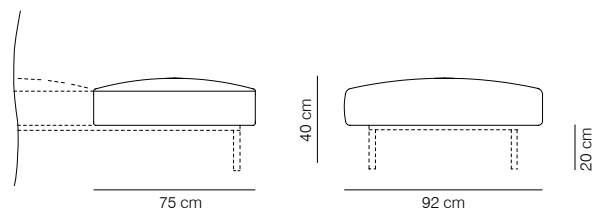

To calculate the volume and number of boxes, please contact the sales department.

CODE	FINISHES	PUBLIC PRICE
SISSRP-1	smooth upholstery	G1 (T/C) 5.399 DKK
SISSRP-2		G2 5.560 DKK
SISSRP-3		G3 5.966 DKK
SISSRP-4		G4 6.390 DKK
SISSRP-5		G5 6.797 DKK
SISSRPS-1	soft upholstery	G1 (T/C) 6.178 DKK
SISSRPS-2		G2 6.433 DKK
SISSRPS-3		G3 6.899 DKK
SISSRPS-4		G4 7.314 DKK
SISSRPS-5		G5 7.789 DKK

Medium backrest module

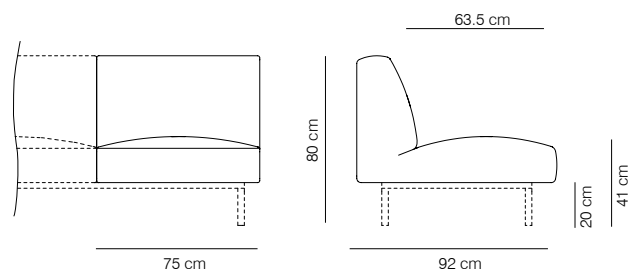

To calculate the volume and number of boxes, please contact the sales department.

CODE	FINISHES	PUBLIC PRICE
SISMP-1	smooth upholstery	G1 (T/C) 7.678 DKK
SISMP-2		G2 8.204 DKK
SISMP-3		G3 9.034 DKK
SISMP-4		G4 9.916 DKK
SISMP-5		G5 10.746 DKK
SISMPS-1	soft upholstery	G1 (T/C) 8.822 DKK
SISMPS-2		G2 9.348 DKK
SISMPS-3		G3 10.424 DKK
SISMPS-4		G4 11.365 DKK
SISMPS-5		G5 12.357 DKK

NOTE 1: There is no possibility to combine smooth upholstery modules and soft upholstery modules.

NOTE 2: The sofas with legs must be composed with a minimum of two modules.

NOTE 3: Legs not included in the package or the price.

Sistema Legs

2016, BY LIEVORE ALTHERR MOLINA

SOFAS

Needed fabric for material
1.40 m wide:
Smooth high backrest: 3 m
Soft high backrest: 3.70 m
Corner: 4.20 m

High backrest module

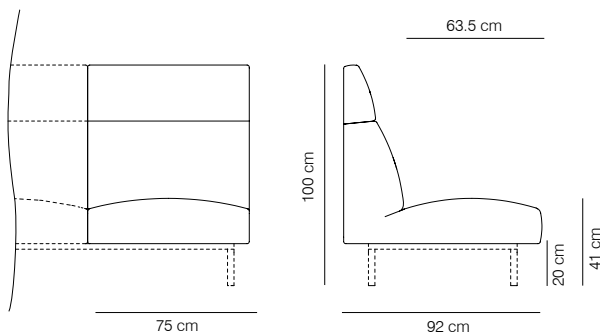

 To calculate the volume and number of boxes, please contact the sales department.

CODE	FINISHES	PUBLIC PRICE
SISAP-1	smooth upholstery	G1 (T/C) 8.458 DKK
SISAP-2		G2 8.924 DKK
SISAP-3		G3 10.017 DKK
SISAP-4		G4 11.001 DKK
SISAP-5		G5 12.034 DKK
SISAPS-1	soft upholstery	G1 (T/C) 9.653 DKK
SISAPS-2		G2 10.280 DKK
SISAPS-3		G3 11.467 DKK
SISAPS-4		G4 12.662 DKK
SISAPS-5		G5 13.857 DKK

Corner module

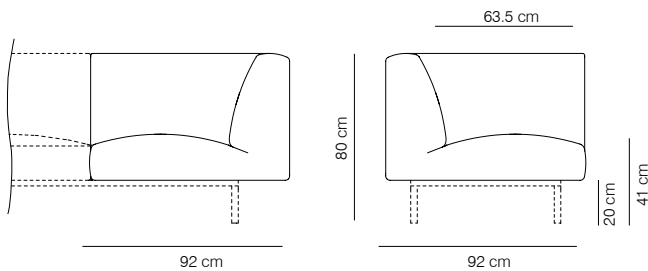

 To calculate the volume and number of boxes, please contact the sales department.

CODE	FINISHES	PUBLIC PRICE
SISRIP-1	smooth upholstery	G1 (T/C) 11.323 DKK
SISRIP-2		G2 12.034 DKK
SISRIP-3		G3 13.492 DKK
SISRIP-4		G4 14.789 DKK
SISRIP-5		G5 16.196 DKK
SISRIPS-1	soft upholstery	G1 (T/C) 13.026 DKK
SISRIPS-2		G2 13.857 DKK
SISRIPS-3		G3 15.467 DKK
SISRIPS-4		G4 17.069 DKK
SISRIPS-5		G5 18.637 DKK

NOTE 1: There is no possibility to combine smooth upholstery modules and soft upholstery modules.

NOTE 2: The sofas with legs must be composed with a minimum of two modules.

NOTE 3: Legs not included in the package or the price.

ARMREST OPTIONS

Needed fabric for material
1.40 m wide:
Medium wood: 0.7 m
Medium upholstered: 1.3 m

Upholstered - wooden medium armrest

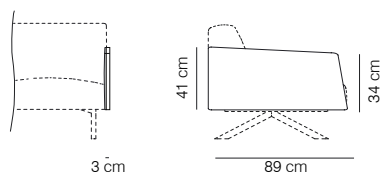

4.5 kg

Installed and included in the package

CODE		FINISHES		PUBLIC PRICE	
RIGHT	LEFT	STAINED	UPHOLSTERY		
SISBRMEPD-1	SISBRMEPI-1	matt oak, cognac, ash, bleached oak or walnut	smooth upholstery	G1 (T/C)	1.992 DKK
SISBRMEPD-2	SISBRMEPI-2			G2	2.093 DKK
SISBRMEPD-3	SISBRMEPI-3			G3	2.288 DKK
SISBRMEPD-4	SISBRMEPI-4			G4	2.483 DKK
SISBRMEPD-5	SISBRMEPI-5			G5	2.687 DKK

Armrest made of natural european oak plywood, stained in the finishes of our collection on the exterior, and upholstered on the interior.

Fully upholstered medium armrest

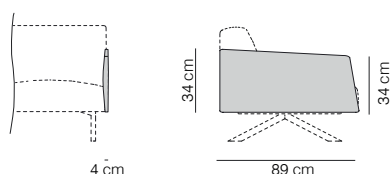

4.8 kg

Installed and included in the package

CODE		FINISHES	PUBLIC PRICE	
RIGHT	LEFT			
SISBRMECPD-1	SISBRMECPI-1	smooth upholstery	G1 (T/C)	2.161 DKK
SISBRMECPD-2	SISBRMECPI-2		G2	2.348 DKK
SISBRMECPD-3	SISBRMECPI-3		G3	2.712 DKK
SISBRMECPD-4	SISBRMECPI-4		G4	3.076 DKK
SISBRMECPD-5	SISBRMECPI-5		G5	3.441 DKK

Armrest made of natural european oak plywood upholstered on both sides.

Sistema Legs

2016, BY LIEVORE ALTHERR MOLINA

SOFAS

Upholstered narrow armrest

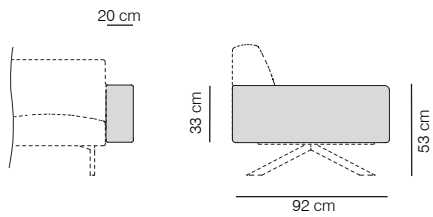

6.8 kg

Installed and included in the package

CODE		FINISHES	PUBLIC PRICE
RIGHT	LEFT		
SISBRFPD-1	SISBRFPI-1	smooth upholstery	G1 (T/C) 2.331 DKK
SISBRFPD-2	SISBRFPI-2		G2 2.856 DKK
SISBRFPD-3	SISBRFPI-3		G3 3.365 DKK
SISBRFPD-4	SISBRFPI-4		G4 3.992 DKK
SISBRFPD-5	SISBRFPI-5		G5 4.780 DKK
SISBRFPSD-1	SISBRFPSI-1	soft upholstery	G1 (T/C) 3.009 DKK
SISBRFPSD-2	SISBRFPSI-2		G2 3.475 DKK
SISBRFPSD-3	SISBRFPSI-3		G3 3.992 DKK
SISBRFPSD-4	SISBRFPSI-4		G4 4.678 DKK
SISBRFPSD-5	SISBRFPSI-5		G5 5.399 DKK

Needed fabric for material 1.40 m wide:
Narrow armrest: 2.20 m
Upholstered curved wood: 1.50 m

Wood structure covered with polyester fibre and non-deformable, expanded polyurethane foam of varying densities.

Curved wood or upholstered armrest

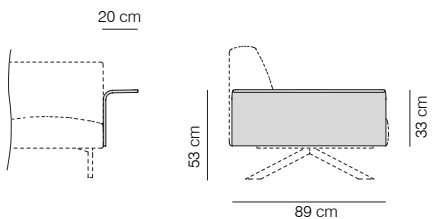

7.8 kg

Installed and included in the package

CODE		FINISHES	PUBLIC PRICE
RIGHT	LEFT		
SISBRMPD	SISBRMPI	stained matt oak, cognac, ash, bleached oak or walnut	2.076 DKK
SISBRTPD-1	SISBRTPI-1	smooth upholstery	G1 (T/C) 3.737 DKK
SISBRTPD-2	SISBRTPI-2		G2 4.153 DKK
SISBRTPD-3	SISBRTPI-3		G3 4.721 DKK
SISBRTPD-4	SISBRTPI-4		G4 5.238 DKK
SISBRTPD-5	SISBRTPI-5		G5 5.856 DKK

Curved oak plywood arm, stained with the finishes of our collection or upholstered.

NOTE: Due to the fact that the wood used is natural, the finish may vary.

Needed fabric for material
1.40 m wide:
Upholstered-wooden: 1.50 m
Fully upholstered: 2.60 m

Upholstered - wooden high armrest

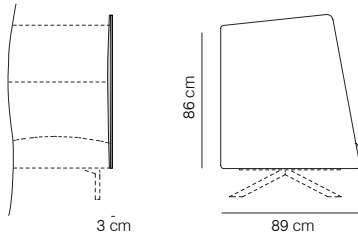

13 kg
Instalado en el sofa e incluido en la caja

CODE		FINISHES		PUBLIC PRICE	
RIGHT	LEFT	STAINED	UPHOLSTERY		
SISBRHD-1	SISBRHI-1	matt oak, cognac, ash, bleached oak or walnut	smooth upholstery	G1 (T/C)	4.102 DKK
SISBRHD-2	SISBRHI-2			G2	4.610 DKK
SISBRHD-3	SISBRHI-3			G3	5.187 DKK
SISBRHD-4	SISBRHI-4			G4	5.763 DKK
SISBRHD-5	SISBRHI-5			G5	6.483 DKK

Armrest made of natural european oak plywood, stained in the finishes of our collection on the exterior, and upholstered on the interior. Only compatible with high backrest modules.

NOTE: Due to the fact that the wood used is natural, the finish may vary.

Fully upholstered high armrest

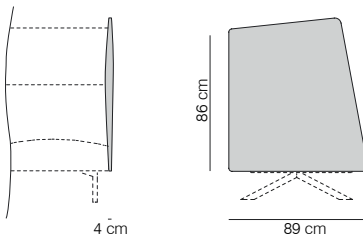

13 kg
Instalado en el sofa e incluido en la caja

CODE		FINISHES		PUBLIC PRICE	
RIGHT	LEFT	STAINED	UPHOLSTERY		
SISBRHCD-1	SISBRHCI-1	smooth upholstery	smooth upholstery	G1 (T/C)	3.898 DKK
SISBRHCD-2	SISBRHCI-2			G2	4.356 DKK
SISBRHCD-3	SISBRHCI-3			G3	4.932 DKK
SISBRHCD-4	SISBRHCI-4			G4	5.509 DKK
SISBRHCD-5	SISBRHCI-5			G5	6.136 DKK

Armrest made of natural european oak plywood upholstered on both sides. Only compatible with high backrest modules.

LEGS OPTIONS

Scissor leg

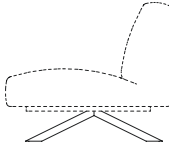

6.6 kg

(x1) 29x83x39.5cm (0.10 m³)

NOTE: Price per unit

CODE	FINISHES	PUBLIC PRICE
SISPTI	black or white	1.864 DKK

Calibrated steel tube powder coated with tempered polyester, in the finishes from our collection.

Cylinder leg

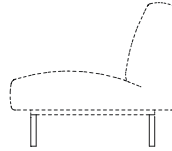

0.6 kg

(x1) 22x6x10.5cm (0.001 m³)*

NOTE: The package contains 2 units.

CODE	FINISHES	PUBLIC PRICE
SISPMET	black or white	1.034 DKK

Calibrated steel tube powder coated with tempered polyester, in the finishes from our collection.*

Flute leg

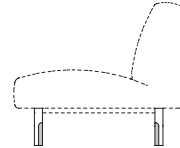

0.4 kg

(x1) 22x6x10.5cm (0.001 m³)*

NOTE: The package contains 2 units.

CODE	FINISHES	PUBLIC PRICE
SISPFLL	stained matt oak, cognac, ash, bleached oak or walnut	1.653 DKK

Wooden solid oak legs*, with carvings on the sides, stained in the finishes from our collection.**

Upholstered scissor leg

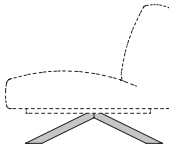

6.6 kg

(x1) 29x83x39.5cm (0.10 m³)

NOTE: Price per unit

CODE	FINISHES	PUBLIC PRICE
SISPTITP	ecoleather	2.746 DKK
SISPTITL	leather	2.907 DKK

Calibrated steel tube powder coated with tempered polyester, upholstered with leather or ecoleather.

Upholstered cylinder leg

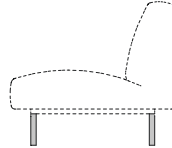

0.6 kg

(x1) 22x6x10.5cm (0.001 m³)*

NOTE: The package contains 2 units.

CODE	FINISHES	PUBLIC PRICE
SISPMETTP	ecoleather	1.500 DKK
SISPMETTL	leather	1.653 DKK

Calibrated steel tube powder coated with tempered polyester, upholstered with leather or ecoleather.*



+ 4€  *The price is per each pair of legs
**Felt glides available with an upcharge of 4€.
If not indicated, the chair will be produced with plastic glides.
NOTE: Due to the fact that the wood used is natural, the finish may vary.

TABLE OPTIONS

Low table

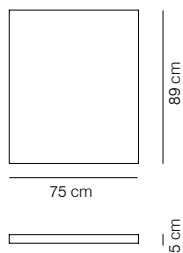

 To calculate the volume and number of boxes, please contact the sales department.

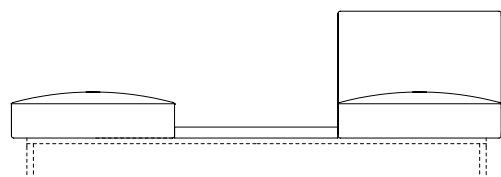

CODE	FINISHES		PUBLIC PRICE
SISMBRO	stained (oak plywood)	matt oak, cognac, ash, bleached oak or walnut	4.204 DKK
SISMBTX	lacquered (MDF)	black or white	3.170 DKK
		taupe, brick, ochre, olive green, dusty pink or dusty green	3.365 DKK

Table in lacquered microtexturized MDF or stained oak plywood with the finishes from our collection.

Wooden box table

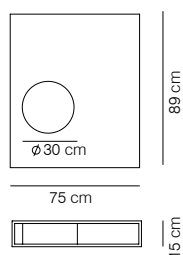

 To calculate the volume and number of boxes, please contact the sales department.

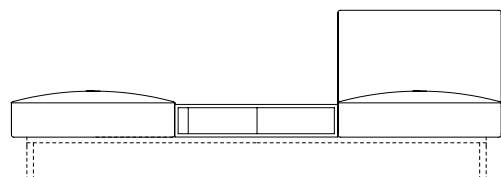

CODE	FINISHES			PUBLIC PRICE
	CYLINDER	EXTERIOR		
SISMPRO	black, white, taupe, brick, ochre, olive green, dusty pink, dusty green or bronze	stained	matt oak	9.916 DKK
			cognac or ash	11.365 DKK
SISMPCTX	lacquered	black or white	taupe, brick, ochre, olive green, dusty pink or dusty green	6.543 DKK
			taupe, brick, ochre, olive green, dusty pink or dusty green	7.060 DKK

Table with a stained European oak plywood or lacquered microtexturized MDF tabletop in the finishes from our collection. Interior plywood cylinder lacquered with the finishes from our collection.

Sistema Legs

2016, BY LIEVORE ALTHERR MOLINA

SOFAS

POUFS

- 1- Interior structure in solid wood covered with expanded polyuretane foam in different densities.
- 2- Polyester fibre covering.
- 3- Fabric or leather.
- 4- Height equalising legs.

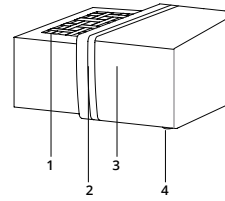

Needed fabric for material
1.40 m wide:
Smooth round pouf: 3.05 m
Soft round pouf: 3.75 m
Smooth squared pouf: 2.60 m
Soft squared pouf: 2.95 m

Round pouf

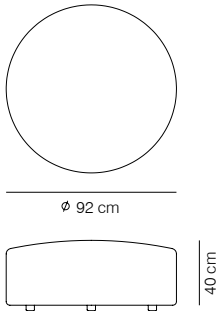

- 📦 20.9 kg
- 📦 (x1) 43x96x96cm (0.40 m³)

CODE		FINISHES	PUBLIC PRICE	
SOFT	SMOOTH		SOFT	SMOOTH
SISPORS-1	SISPOR-1	G1 (T/C)	6.644 DKK	5.755 DKK
SISPORS-2	SISPOR-2	G2	7.212 DKK	6.382 DKK
SISPORS-3	SISPOR-3	G3	7.831 DKK	7.000 DKK
SISPORS-4	SISPOR-4	G4	8.568 DKK	7.678 DKK
SISPORS-5	SISPOR-5	G5	9.289 DKK	8.458 DKK

Squared pouf

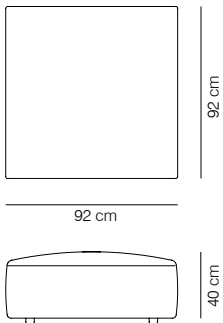

- 📦 31 kg
- 📦 (x1) 43x96x96cm (0.40 m³)

CODE		FINISHES	PUBLIC PRICE	
SOFT	SMOOTH		SOFT	SMOOTH
SISPOCS-1	SISPOC-1	G1 (T/C)	6.433 DKK	5.560 DKK
SISPOCS-2	SISPOC-2	G2	6.958 DKK	6.068 DKK
SISPOCS-3	SISPOC-3	G3	7.526 DKK	6.687 DKK
SISPOCS-4	SISPOC-4	G4	8.255 DKK	7.365 DKK
SISPOCS-5	SISPOC-5	G5	8.975 DKK	8.144 DKK

Upholstered modules that allow angular or straight compositions.

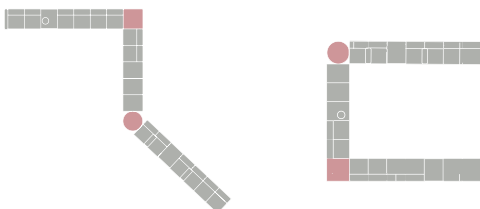

NOTE: There is no possibility to combine smooth upholstery modules with soft upholstery modules

ACCESSORIES

Needed fabric for material

1.40 m wide:

Free arm: 0.85 m

Headrest: 0.7 m

Free table

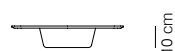
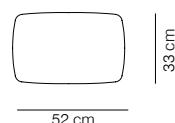

2.8 kg

(x1) 16x60x41 cm (0.04m³)

CODE	FINISHES		PUBLIC PRICE
SISMARO	stained	matt oak, cognac, ash, bleached oak or walnut	1.559 DKK
SISMATX	lacquered	black or white	1.559 DKK
		taupe, brick, ochre, olive green, dusty pink or dusty green	1.712 DKK
		bronze	1.864 DKK

Table with a stained European oak plywood or lacquered microtexturized MDF tabletop in the finishes from our collection.

NOTE: Due to the fact that the wood used is natural, the finish may vary.

Free armrest

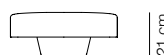
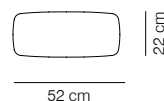

2.6 kg

(x1) 23x60x41 cm (0.06m³)

CODE	FINISHES	0	PUBLIC PRICE
SISBRA-1	upholstered	G1 (T/C)	0 DKK 4.509 DKK
SISBRA-2		G2	0 DKK 4.619 DKK
SISBRA-3		G3	0 DKK 4.822 DKK
SISBRA-4		G4	0 DKK 5.085 DKK
SISBRA-5		G5	0 DKK 5.288 DKK

Upholstered armrest with MDF structure, lacquered in black with expanded nondeformable polyurethane foam, of different densities and polyester fibre.

Fixed sidetable

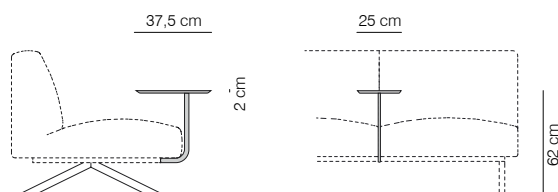

4 kg

(x1) 53x53x25 cm (0.07m³)

CODE	FINISHES		PUBLIC PRICE
	STRUCTURE	TABLE	
SISMAF	black or white	stained	1.780 DKK
		cognac or ash	1.949 DKK

MDF with european oak veneer tabletop, polished in the finishes of our collection. Arm in calibrated steel tube, lacquered in white or black. The arm is always the same color as the structure of the sofa.

Headrest

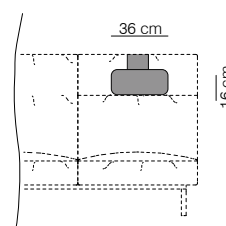

0.9 kg

(x1) 25x33x11.5 cm (0.009 m³)

CODE	FINISHES	PUBLIC PRICE
SISRE-1	upholstered	G1 (T/C) 1.034 DKK
SISRE-2		G2 1.093 DKK
SISRE-3		G3 1.398 DKK
SISRE-4		G4 1.653 DKK
SISRE-5		G5 1.924 DKK

Accessorie that adapts perfectly to the shape of the backrest, enhancing comfort in situations when prolonged rest is needed.

It requires no installation and is available in all the fabrics of our collection. Only available for modules with high backrest.

Sistema Legs

2016, BY LIEVORE ALTHERR MOLINA

SOFAS

CUSHIONS

Cushions made of 100% siliconized high performance microfiber with anti-dust mite treatment.

Cushion 60x30

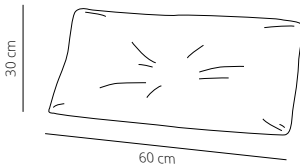

1.2 kg
 (x1) 60x42x16 cm (0.04 m³)

CODE	FINISHES		PUBLIC PRICE
SISAL30-1	upholstered	G1 (T/C)	415 DKK
SISAL30-2		G2	525 DKK
SISAL30-3		G3	729 DKK
SISAL30-4		G4	1.195 DKK
SISAL30-5		G5	1.458 DKK

Cushion 50x50

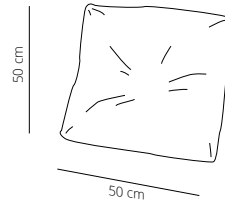

2 kg
 (x1) 53x53x21 cm (0.06 m³)

CODE	FINISHES		PUBLIC PRICE
SISAL50-1	upholstered	G1 (T/C)	525 DKK
SISAL50-2		G2	670 DKK
SISAL50-3		G3	1.034 DKK
SISAL50-4		G4	1.610 DKK
SISAL50-5		G5	1.864 DKK

Needed fabric for material
 1.40 m wide:
Cushion 60x30: 0.45 m
Cushion 50x50: 0.70 m

POWER OPTIONS

Under seat powerbox

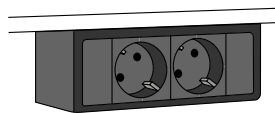

1.7 kg
(x1) 34x18x9cm (0.05 m³)

CODE	FINISHES	PUBLIC PRICE
SISEL-E	black	2.814 DKK

Powerbox available with two sockets or combined with built-in multimedia devices.

Dimensions: 16.8x5.4x5.4 cm

For all available power options *see page 505*.

The cable length is 0.3 meters with Wieland connector. The power connection cable is not included, and will have to be provided by the customer.

USB hub

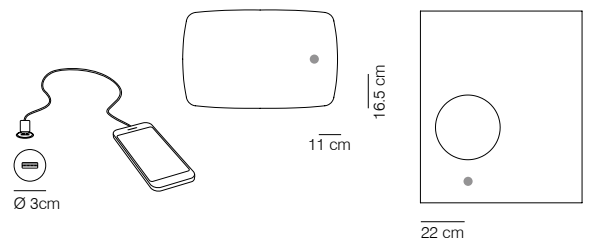

Instalado e incluido en la caja

CODE	FINISHES	PUBLIC PRICE
SISUSB	black or white	525 DKK

Built-in USB hub for charging electronic devices.

Available in white or black for the free table and the wooden box table in the preset positions.

Dimensions: Ø 30 mm

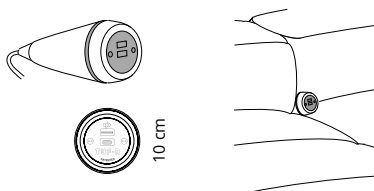
Seat powerbox **NEW**

1.6 kg
(x1) 34x18x9 cm (0.05 m³)

CODE	FINISHES	PUBLIC PRICE
SISCON-E	black or white	1.186 DKK
SISCON-U		2.424 DKK

Detachable free powerbox between seats.

SISCON-E: Powerbox with one slot for socket.

SISCON-U: Detachable free powerbox with USB - A and a USB - C.

Dimensions: Ø6.6x15 cm

For all available power options *see page 506*.

The cable length is 0.80 m with Wieland connector. The power connection cable is not included, and will have to be provided by the customer.



Sistema Floor

BY LIEVORE ALTHERR MOLINA

LOUNGE CHAIR SUGGESTIONS

Composition 1

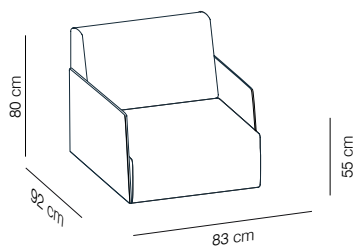

CODE	FINISHES	PUBLIC PRICE	
ARMCHAIR COMPOSITION 1	smooth upholstery	G1 (T/C)	11.890 DKK
		G2	12.865 DKK
		G3	14.857 DKK
		G4	16.492 DKK
		G5	18.399 DKK
	soft upholstery	G1 (T/C)	13.035 DKK
		G2	14.060 DKK
		G3	16.204 DKK
		G4	17.950 DKK
		G5	19.959 DKK

Components: 1 x SISM
2 x SISBRMEC

Composition 2

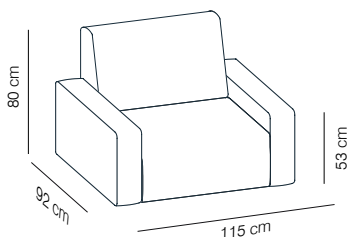

CODE	FINISHES	PUBLIC PRICE	
ARMCHAIR COMPOSITION 2	smooth upholstery	G1 (T/C)	12.145 DKK
		G2	13.713 DKK
		G3	15.823 DKK
		G4	17.798 DKK
		G5	20.348 DKK
	soft upholstery	G1 (T/C)	14.645 DKK
		G2	16.145 DKK
		G3	18.425 DKK
		G4	20.628 DKK
		G5	23.145 DKK

Components: 1 x SISM
2 x SISBRF

Composition 3

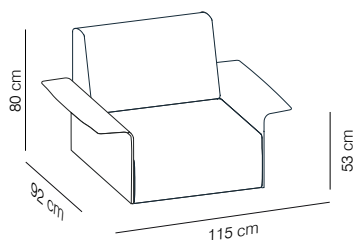

CODE	FINISHES	PUBLIC PRICE	
ARMCHAIR COMPOSITION 3	smooth upholstery	G1 (T/C)	13.280 DKK
		G2	13.797 DKK
		G3	14.891 DKK
		G4	15.611 DKK
		G5	16.603 DKK
	soft upholstery	G1 (T/C)	14.424 DKK
		G2	14.992 DKK
		G3	16.238 DKK
		G4	17.069 DKK
		G5	18.162 DKK

Components: 1 x SISM
2 x SISBRM

Sistema Floor

2016, BY LIEVORE ALTHERR MOLINA

SOFAS

Composition 4

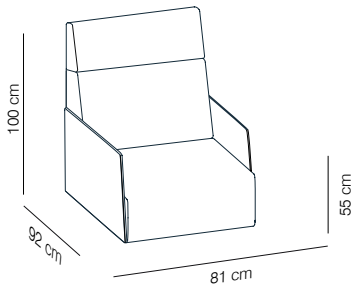

CODE	FINISHES		PUBLIC PRICE
ARMCHAIR COMPOSITION 4	smooth upholstery	G1 (T/C)	12.297 DKK
		G2	13.119 DKK
		G3	14.772 DKK
		G4	16.425 DKK
		G5	18.111 DKK
	soft upholstery	G1 (T/C)	13.492 DKK
		G2	14.374 DKK
		G3	16.221 DKK
		G4	18.035 DKK
		G5	19.874 DKK

Components: 1 x SISA
2 x SISBRME

Composition 5

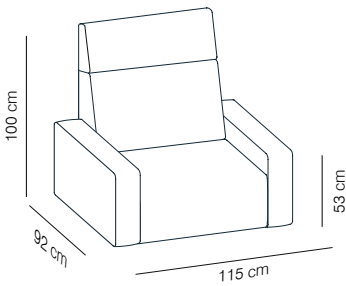

CODE	FINISHES		PUBLIC PRICE
ARMCHAIR COMPOSITION 5	smooth upholstery	G1 (T/C)	12.975 DKK
		G2	14.594 DKK
		G3	16.755 DKK
		G4	19.153 DKK
		G5	21.908 DKK
	soft upholstery	G1 (T/C)	15.526 DKK
		G2	17.086 DKK
		G3	19.459 DKK
		G4	22.137 DKK
		G5	24.908 DKK

Components: 1 x SISA
2 x SISBRF

Composition 6

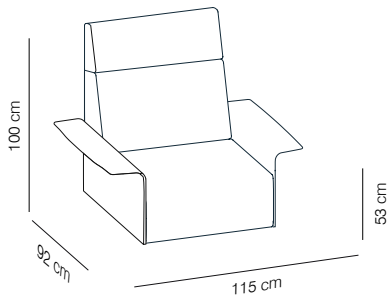

CODE	FINISHES		PUBLIC PRICE
ARMCHAIR COMPOSITION 6	smooth upholstery	G1 (T/C)	14.840 DKK
		G2	16.255 DKK
		G3	18.433 DKK
		G4	20.713 DKK
		G5	23.145 DKK
	soft upholstery	G1 (T/C)	16.035 DKK
		G2	17.509 DKK
		G3	19.882 DKK
		G4	22.323 DKK
		G5	24.908 DKK

Components: 1 x SISA
2 x SISBRT

SUGGESTIONS

Composition 1

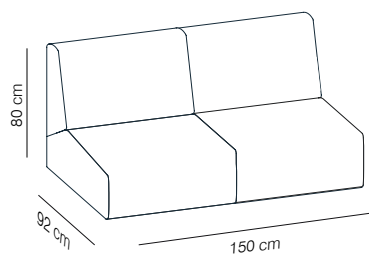

CODE	FINISHES	PUBLIC PRICE	
SOFA COMPOSITION 1	smooth upholstery	G1 (T/C)	14.119 DKK
		G2	15.153 DKK
		G3	17.340 DKK
		G4	18.781 DKK
		G5	20.764 DKK
	soft upholstery	G1 (T/C)	16.408 DKK
		G2	17.543 DKK
		G3	20.035 DKK
		G4	21.696 DKK
		G5	23.883 DKK

Components: 2 x SISM

Composition 2

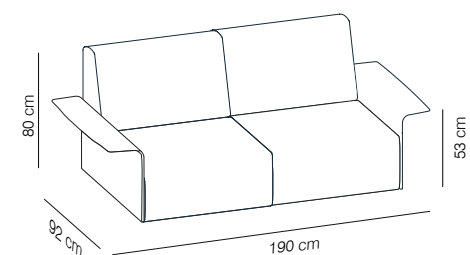

CODE	FINISHES	PUBLIC PRICE	
SOFA COMPOSITION 2	smooth upholstery	G1 (T/C)	20.340 DKK
		G2	21.374 DKK
		G3	23.560 DKK
		G4	25.001 DKK
		G5	26.984 DKK
	soft upholstery	G1 (T/C)	22.628 DKK
		G2	23.764 DKK
		G3	26.256 DKK
		G4	27.917 DKK
		G5	30.103 DKK

Components: 2 x SISM
2 x SISBRM

Composition 3

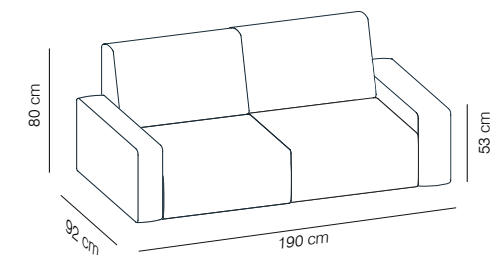

CODE	FINISHES	PUBLIC PRICE	
SOFA COMPOSITION 3	smooth upholstery	G1 (T/C)	19.204 DKK
		G2	21.289 DKK
		G3	24.493 DKK
		G4	27.188 DKK
		G5	30.730 DKK
	soft upholstery	G1 (T/C)	22.849 DKK
		G2	24.916 DKK
		G3	28.442 DKK
		G4	31.476 DKK
		G5	35.086 DKK

Components: 2 x SISM
2 x SISBRF

Sistema Floor

2016, BY LIEVORE ALTHERR MOLINA

SOFAS

Composition 4

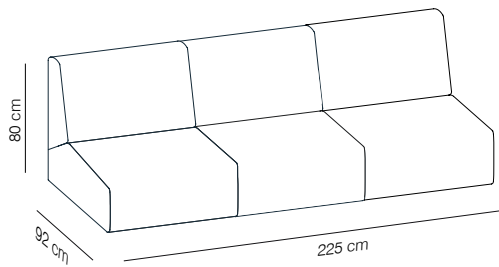

CODE	FINISHES	PUBLIC PRICE	
SOFA COMPOSITION 4	smooth upholstery	G1 (T/C)	21.179 DKK
		G2	22.730 DKK
		G3	26.010 DKK
		G4	28.171 DKK
		G5	31.146 DKK
	soft upholstery	G1 (T/C)	24.611 DKK
		G2	26.315 DKK
		G3	30.052 DKK
		G4	32.544 DKK
		G5	35.824 DKK

Components: 3 x SISM

Composition 5

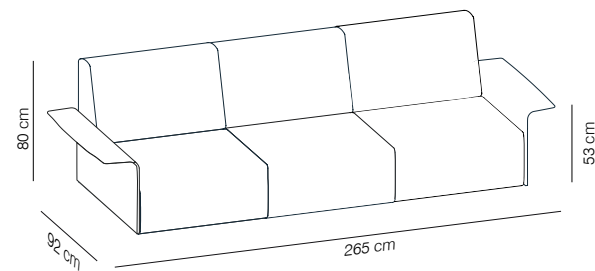

CODE	FINISHES	PUBLIC PRICE	
SOFA COMPOSITION 5	smooth upholstery	G1 (T/C)	27.400 DKK
		G2	28.951 DKK
		G3	32.230 DKK
		G4	34.392 DKK
		G5	37.366 DKK
	soft upholstery	G1 (T/C)	30.832 DKK
		G2	32.536 DKK
		G3	36.273 DKK
		G4	38.765 DKK
		G5	42.044 DKK

Components: 3 x SISM
2 x SISBRM

Composition 6

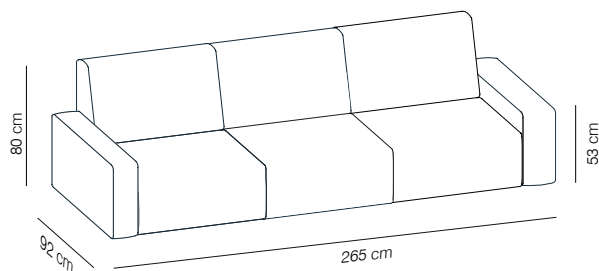

CODE	FINISHES	PUBLIC PRICE	
SOFA COMPOSITION 6	smooth upholstery	G1 (T/C)	26.264 DKK
		G2	28.866 DKK
		G3	33.163 DKK
		G4	36.578 DKK
		G5	41.112 DKK
	soft upholstery	G1 (T/C)	31.052 DKK
		G2	33.688 DKK
		G3	38.460 DKK
		G4	42.324 DKK
		G5	47.028 DKK

Components: 3 x SISM
2 x SISBRF

SOFAS

Test certificates: ANSI/BIFMA X5.4-2012 and UNE EN 16139:2013

- 1- Interior structure in steel, solid wood and plywood covered with expanded polyuretane foam in different densities.
- 2- Polyester fibre covering.
- 3- Fabric or leather.
- 4- Height equalising legs.

Needed fabric for material
1.40 m wide:
Smooth backless module: 2 m
Soft backless module: 2.1 m
Medium backrest: 3.60 m

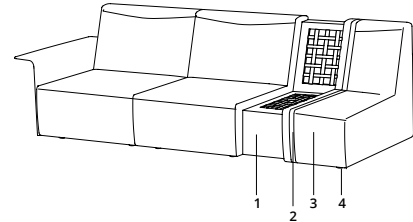

BACKREST OPTIONS

Backless module

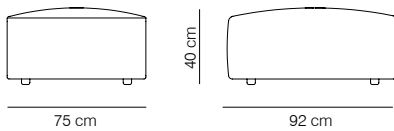

- 👤 27.8 kg
- 📦 (x1) 45x98x79cm (0.35 m³)

CODE	FINISHES	PUBLIC PRICE
SISSR-1	smooth upholstery	G1 (T/C) 4.822 DKK
SISSR-2		G2 5.034 DKK
SISSR-3		G3 5.449 DKK
SISSR-4		G4 5.856 DKK
SISSR-5		G5 6.331 DKK
SISSRS-1	soft upholstery	G1 (T/C) 5.509 DKK
SISSRS-2		G2 5.763 DKK
SISSRS-3		G3 6.331 DKK
SISSRS-4		G4 6.797 DKK
SISSRS-5		G5 7.314 DKK

Medium backrest module

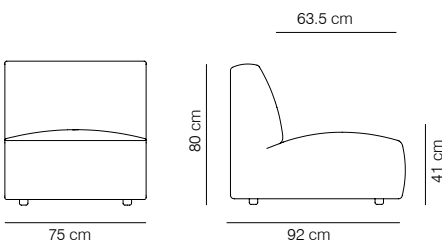

- 👤 36.4 kg
- 📦 (x1) 85x96x81cm (0.66 m³)

CODE	FINISHES	PUBLIC PRICE
SISM-1	smooth upholstery	G1 (T/C) 7.060 DKK
SISM-2		G2 7.577 DKK
SISM-3		G3 8.670 DKK
SISM-4		G4 9.390 DKK
SISM-5		G5 10.382 DKK
SISMS-1	soft upholstery	G1 (T/C) 8.204 DKK
SISMS-2		G2 8.772 DKK
SISMS-3		G3 10.017 DKK
SISMS-4		G4 10.848 DKK
SISMS-5		G5 11.941 DKK

NOTE 1: There is no possibility to combine smooth upholstery modules and soft upholstery modules.

Sistema Floor

2016, BY LIEVORE ALTHERR MOLINA

SOFAS

Needed fabric for material
1.40 m wide:
Smooth high backrest: 4.25 m
Soft high backrest: 4.30 m

High backrest module

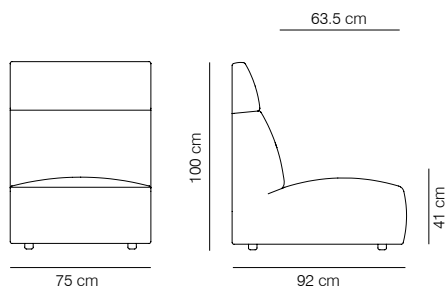

40 kg

(x1) 108x97x80cm (0.79 m³)

CODE	FINISHES	PUBLIC PRICE
SISA-1	smooth upholstery	G1 (T/C) 7.890 DKK
SISA-2		G2 8.458 DKK
SISA-3		G3 9.602 DKK
SISA-4		G4 10.746 DKK
SISA-5		G5 11.941 DKK
SISAS-1	soft upholstery	G1 (T/C) 9.085 DKK
SISAS-2		G2 9.712 DKK
SISAS-3		G3 11.051 DKK
SISAS-4		G4 12.357 DKK
SISAS-5		G5 13.704 DKK

NOTE 1: There is no possibility to combine smooth upholstery modules and soft upholstery modules.

ARMREST OPTIONS

Needed fabric for material
1.40 m wide:
Medium wood: 0.9 m
Medium upholstered: 1.6 m

Upholstered - wooden medium armrest

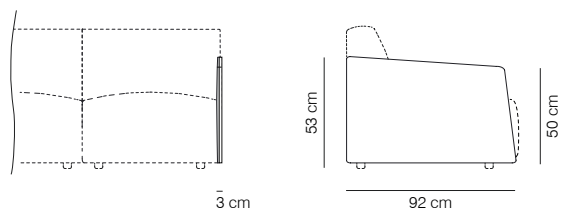

8.6 kg
Installed and included in the box

CODE		FINISHES		PUBLIC PRICE	
RIGHT	RIGHT	STAIN	UPHOLSTERY		
SISBRMED-1	SISBRMEI-1	matt oak, cognac, ash, bleached oak or walnut	smooth upholstery	G1 (T/C)	2.203 DKK
SISBRMED-2	SISBRMEI-2			G2	2.331 DKK
SISBRMED-3	SISBRMEI-3			G3	2.585 DKK
SISBRMED-4	SISBRMEI-4			G4	2.839 DKK
SISBRMED-5	SISBRMEI-5			G5	3.085 DKK

Armrest made of natural european oak plywood, stained in the finishes of our collection on the exterior, and upholstered on the interior.

Fully upholstered medium armrest

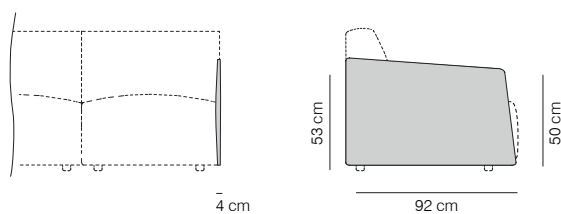

8.9 kg
Installed and included in the box

CODE		FINISHES		PUBLIC PRICE
RIGHT	RIGHT	UPHOLSTERY		
SISBRMECD-1	SISBRMECI-1	smooth upholstery	G1 (T/C)	2.415 DKK
SISBRMECD-2	SISBRMECI-2		G2	2.644 DKK
SISBRMECD-3	SISBRMECI-3		G3	3.093 DKK
SISBRMECD-4	SISBRMECI-4		G4	3.551 DKK
SISBRMECD-5	SISBRMECI-5		G5	4.009 DKK

Armrest made of natural european oak plywood upholstered on both sides.

ARMREST OPTIONS

Needed fabric for material 1.40 m wide:
Smooth narrow armrest: 1.75 m
Soft narrow armrest: 1.45 m
Curved armrest: 2.30 m

Upholstered narrow armrest

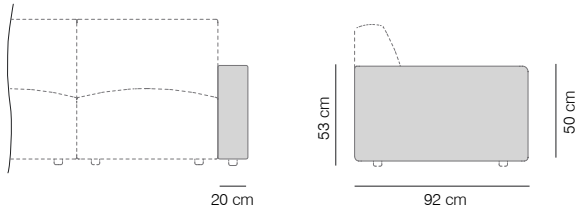

13 kg

Instalado en el sofa e incluido en la caja

CODE		FINISHES		PUBLIC PRICE
RIGHT	RIGHT	UPHOLSTERY		
SISBRFD-1	SISBRFI-1	smooth upholstery	G1 (T/C)	2.542 DKK
SISBRFD-2	SISBRFI-2		G2	3.068 DKK
SISBRFD-3	SISBRFI-3		G3	3.576 DKK
SISBRFD-4	SISBRFI-4		G4	4.204 DKK
SISBRFD-5	SISBRFI-5		G5	4.983 DKK
SISBRFSD-1	SISBRFSI-1	soft upholstery	G1 (T/C)	3.220 DKK
SISBRFSD-2	SISBRFSI-2		G2	3.687 DKK
SISBRFSD-3	SISBRFSI-3		G3	4.204 DKK
SISBRFSD-4	SISBRFSI-4		G4	4.890 DKK
SISBRFSD-5	SISBRFSI-5		G5	5.602 DKK

Wood structure covered with polyester fibre and non-deformable, expanded polyurethane foam of varying densities. With height equalising legs.

Curved wood or upholstered armrest

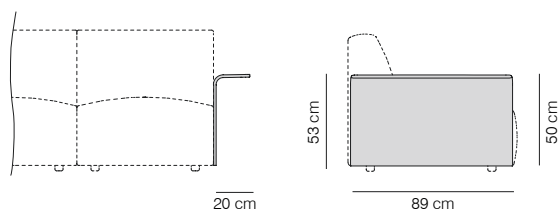

9 kg

Instalado en el sofa e incluido en la caja

CODE		FINISHES		PUBLIC PRICE
RIGHT	LEFT			
SISBRMD	SISBRMI	stained	matt oak, cognac, ash, bleached oak or walnut	3.110 DKK
SISBRTD-1	SISBRTI-1	smooth upholstery	G1 (T/C)	3.475 DKK
SISBRTD-2	SISBRTI-2		G2	3.898 DKK
SISBRTD-3	SISBRTI-3		G3	4.415 DKK
SISBRTD-4	SISBRTI-4		G4	4.983 DKK
SISBRTD-5	SISBRTI-5		G5	5.602 DKK

Curved oak plywood arm, stained with the finishes of our collection or upholstered.

NOTE: Due to the fact that the wood used is natural, the finish may vary.

Needed fabric for material
1.40 m wide:
Wide smooth armrest: 2.30 m
Wide soft armrest: 1.80 m

Upholstered wide armrest

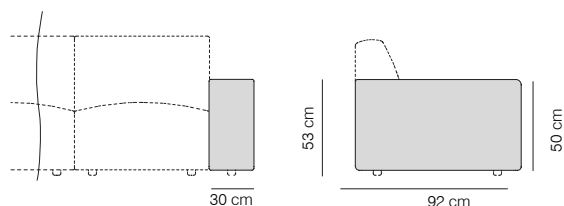

16.6 kg

Instalado en el sofa e incluido en la caja

CODE		FINISHES		PUBLIC PRICE
RIGHT	RIGHT	UPHOLSTERY		
SISBRGD-1	SISBRGI-1	smooth upholstery	G1 (T/C)	3.170 DKK
SISBRGD-2	SISBRGI-2		G2	3.636 DKK
SISBRGD-3	SISBRGI-3		G3	4.153 DKK
SISBRGD-4	SISBRGI-4		G4	4.822 DKK
SISBRGD-5	SISBRGI-5		G5	5.509 DKK
SISBRGSD-1	SISBRGSI-1	soft upholstery	G1 (T/C)	3.788 DKK
SISBRGSD-2	SISBRGSI-2		G2	4.254 DKK
SISBRGSD-3	SISBRGSI-3		G3	4.822 DKK
SISBRGSD-4	SISBRGSI-4		G4	5.449 DKK
SISBRGSD-5	SISBRGSI-5		G5	6.136 DKK

Wood structure covered with polyester fibre and non-deformable, expanded polyurethane foam of varying densities. With height equalising legs.

TABLE OPTIONS

Wooden box table

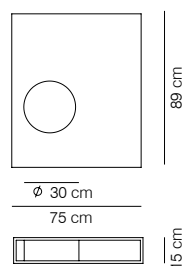

29 kg

97x80x28 cm (0.22m³)

CODE	FINISHES		PUBLIC PRICE	
	CYLINDER	EXTERIOR		
SISMCR0	white, black, taupe, brick, ochre, olive green, dusty pink and dusty green or bronze	stained	matt oak	9.916 DKK
		lacquered	cognac, ash, bleached oak or walnut	11.365 DKK
SISMCTX	lacquered		white or black*	6.543 DKK
		taupe, brick, ochre, olive green, dusty pink or dusty green	7.060 DKK	

Table with a stained European oak plywood or lacquered microtexturized MDF tabletop in the finishes from our collection. Interior plywood cylinder lacquered with the finishes from our collection.

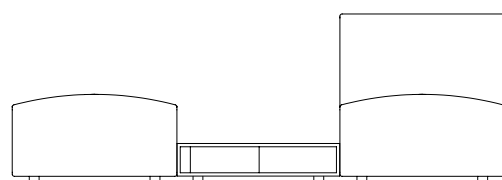

*Example of the table position.

NOTE: Due to the fact that the wood used is natural, the finish may vary.

POUFS

- 1- Interior structure in solid wood covered with expanded polyuretane foam in different densities.
- 2- Polyester fibre covering.
- 3- Fabric or leather.
- 4- Height equalising legs.

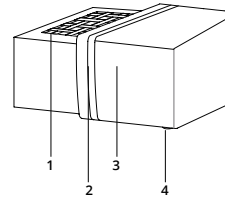

Needed fabric for material
1.40 m wide:
Smooth round pouf: 3.05 m
Soft round pouf: 3.75 m
Smooth squared pouf: 2.60 m
Soft squared pouf: 2.95 m

Round pouf

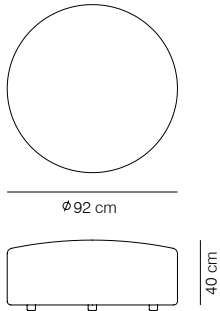

20.9 kg
(x1) 43x96x96cm (0.40 m³)

CODE		FINISHES	PUBLIC PRICE	
SOFT	SMOOTH		SOFT	SMOOTH
SISPORS-1	SISPOR-1	G1 (T/C)	6.644 DKK	5.755 DKK
SISPORS-2	SISPOR-2	G2	7.212 DKK	6.382 DKK
SISPORS-3	SISPOR-3	G3	7.831 DKK	7.000 DKK
SISPORS-4	SISPOR-4	G4	8.568 DKK	7.678 DKK
SISPORS-5	SISPOR-5	G5	9.289 DKK	8.458 DKK

Squared pouf

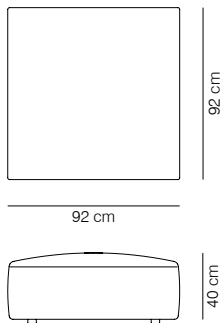

31 kg
(x1) 43x96x96cm (0.40 m³)

CODE		FINISHES	PUBLIC PRICE	
SOFT	SMOOTH		SOFT	SMOOTH
SISPOCS-1	SISPOC-1	G1 (T/C)	6.433 DKK	5.560 DKK
SISPOCS-2	SISPOC-2	G2	6.958 DKK	6.068 DKK
SISPOCS-3	SISPOC-3	G3	7.526 DKK	6.687 DKK
SISPOCS-4	SISPOC-4	G4	8.255 DKK	7.365 DKK
SISPOCS-5	SISPOC-5	G5	8.975 DKK	8.144 DKK

Upholstered modules that allow angular or straight compositions.

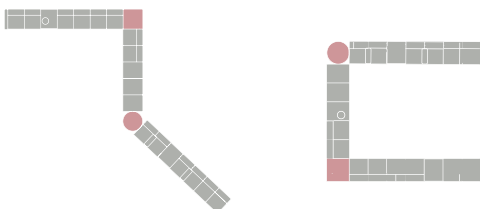

NOTE: There is no possibility to combine smooth upholstery modules with soft upholstery modules

Needed fabric for material

1.40 m wide:

Free arm: 0.85 m

Headrest: 0.7 m

ACCESSORIES

Free table

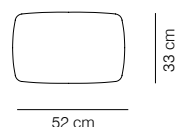

2.8 kg
(x1) 16x60x41 cm (0.04m³)

CODE	FINISHES		PUBLIC PRICE
SISMARO	stained	matt oak, cognac, ash, bleached oak or walnut	1.559 DKK
SISMATX	lacquered	black or white	1.559 DKK
		taupe, brick, ochre, olive green, dusty pink or dusty green	1.712 DKK
		bronze	1.864 DKK

Table with a stained European oak plywood or lacquered microtexturized MDF tabletop in the finishes from our collection.

NOTE: Due to the fact that the wood used is natural, the finish may vary.

Free arm

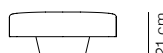
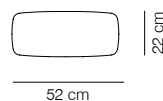

2.6 kg
(x1) 23x60x41 cm (0.06m³)

CODE	FINISHES	0	PUBLIC PRICE
SISBRA-1	upholstered	G1 (T/C)	0 DKK 4.509 DKK
SISBRA-2		G2	0 DKK 4.619 DKK
SISBRA-3		G3	0 DKK 4.822 DKK
SISBRA-4		G4	0 DKK 5.085 DKK
SISBRA-5		G5	0 DKK 5.288 DKK

Upholstered armrest with MDF structure, lacquered in black with expanded nondeformable polyurethane foam, of different densities and polyester fibre.

Headrest

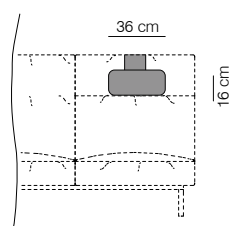

0.9 kg
(x1) 25x33x11.5 cm (0.009 m³)

CODE	FINISHES	PUBLIC PRICE	
SISRE-1	G1 (T/C)	1.034 DKK	
SISRE-2	G2	1.093 DKK	
SISRE-3	upholstered	G3	1.398 DKK
SISRE-4		G4	1.653 DKK
SISRE-5		G5	1.924 DKK

Accessorie that adapts perfectly to the shape of the backrest, enhancing comfort in situations when prolonged rest is needed. It requires no installation and is available in all the fabrics of our collection. Only available for modules with high backrest.

CUSHIONS

Cushions made of 100% siliconized high performance microfiber with anti-dust mite treatment.

Cushion 60x30

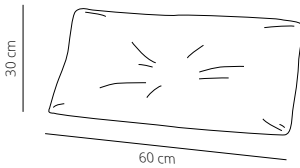

1.2 kg
 (x1) 60x42x16 cm (0.04 m³)

CODE	FINISHES		PUBLIC PRICE
SISAL30-1	upholstered	G1 (T/C)	415 DKK
SISAL30-2		G2	525 DKK
SISAL30-3		G3	729 DKK
SISAL30-4		G4	1.195 DKK
SISAL30-5		G5	1.458 DKK

Cushion 50x50

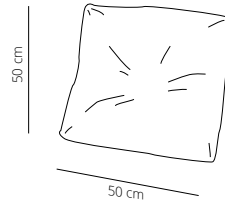

2 kg
 (x1) 53x53x21 cm (0.06 m³)

CODE	FINISHES		PUBLIC PRICE
SISAL50-1	upholstered	G1 (T/C)	525 DKK
SISAL50-2		G2	670 DKK
SISAL50-3		G3	1.034 DKK
SISAL50-4		G4	1.610 DKK
SISAL50-5		G5	1.864 DKK

Needed fabric for material
 1.40 m wide:
 Cushion 60x30: 0.45 m
 Cushion 50x50: 0.70 m

POWER OPTIONS

USB hub

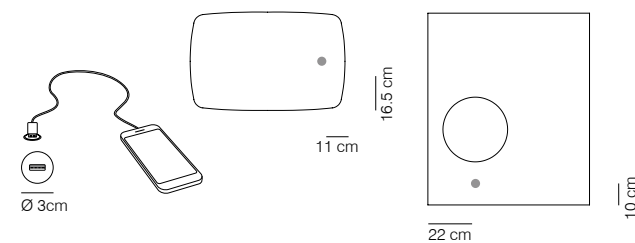

Instalado e incluido en la caja

CODE	FINISHES	PUBLIC PRICE
SAVIUSB	black or white	525 DKK

Built-in USB hub for charging electronic devices.
 Available in white or black for the free table and the wooden box table
 in the preset positions.
 Dimensions: Ø 30 mm

Seat powerbox *NEW*

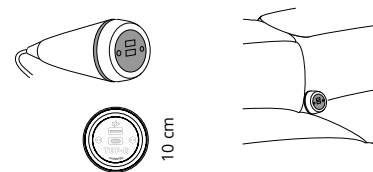

1.6 kg
 (x1) 34x18x9 cm (0.05 m³)

CODE	FINISHES	PUBLIC PRICE
SISCON-E	black or white	1.186 DKK
SISCON-U		2.424 DKK

Detachable free powerbox between seats.
SISCON-E: Powerbox with one slot for socket.
SISCON-U: Detachable free powerbox with USB - A and a USB - C.
Dimensions: Ø6.6x15 cm

For all available power options *see page 506.*

The cable length is 0.80 m with Wieland connector. The power connection cable is not included, and will have to be provided by the customer.



Season Sofa

BY PIERO LISSONI

Test certificates: ANSI/BIFMA X5.4-2012 and UNE EN 16139:2013

SEASON SOFA is a simple and elegant upholstered modular sofa. The collection is composed by different modules, which makes it very easy to create different compositions for waiting areas and living rooms, in a very intuitive way.

The fixed upholstery is available in fabric and leather, to choose from a variety of colors that can be combined with other items of the collection. The base of the SEASON sofa has a grey protection of washable technical fabric.

Perfect for offices, restaurants, receptions, etc.

The tolerance in the measurements of the upholstered elements can be of +/- 3 cm.

NOTE: A sketch must be included with your order to avoid any sort of misunderstanding. Remember that "right" and "left" are understood to be from the perspective of a person looking at the object from the front. The more information you include with your order, the lower the possibility of error.

- 1- Interior structure in solid wood and perforated top of microparticles low in formaldehyde. For the production of this pieces Viccarbe is using wood from certified sustainable forestry sources.
- 2- Expanded polyurethane foam in different densities.
- 3- Fabric or leather.
- 4- Upholstery protection (technical fabric).
- 5- Height equalising legs.

**Check all the technical fabric colours available on [page 22](#).*

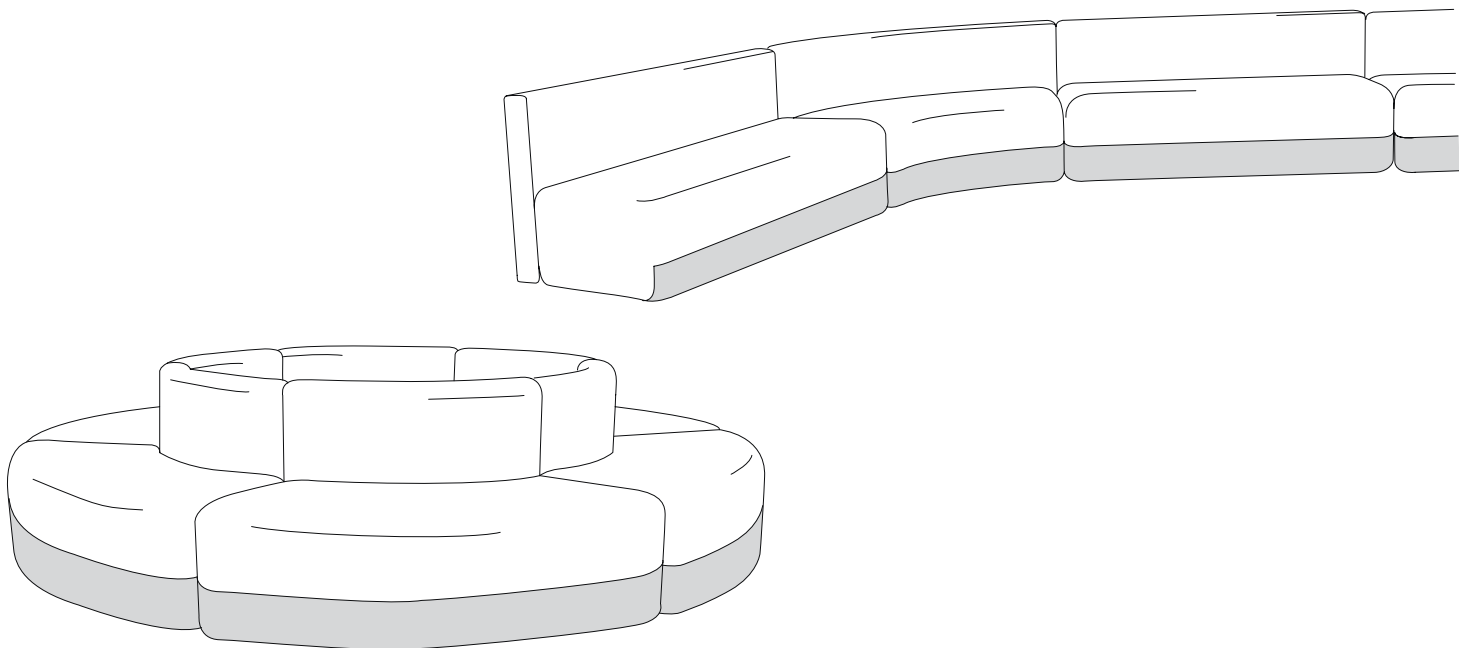
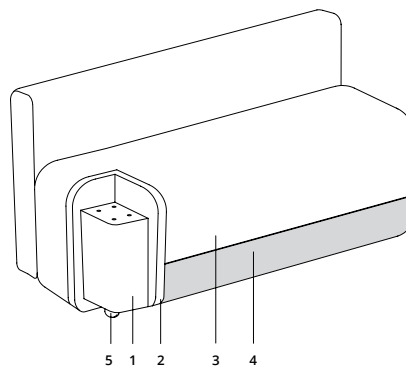
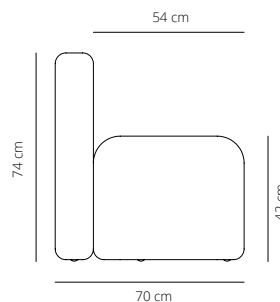

Season Sofa

2017, BY PIERO LISSONI

SOFAS

Needed fabric for material
1.40 m wide:
Module A: 5.55 m
Module B: 5.70 m
Module C: 5.40 m

MODULES

Module A straight

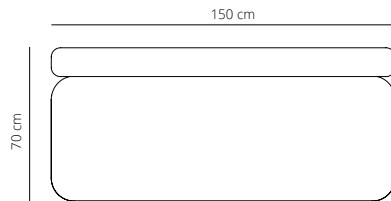

49.6 kg
(x1) 153x76x77cm (0.9 m³)

CODE	FINISHES		PUBLIC PRICE
	UPHOLSTERY PROTECTION	UPHOLSTERY	
SESA-1	light or dark grey technical fabric	G1 (COM/COL)	10.594 DKK
SESA-2		G2	12.501 DKK
SESA-3		G3	14.738 DKK
SESA-4		G4	17.433 DKK
SESA-5		G5	20.552 DKK

Module B closed

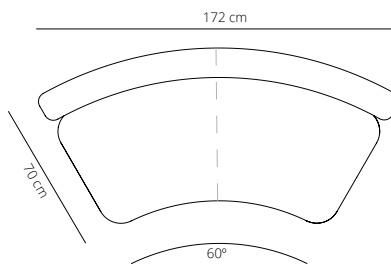

50.2 kg
(x1) 173x85x79cm (1.16 m³)

CODE	FINISHES		PUBLIC PRICE
	UPHOLSTERY PROTECTION	UPHOLSTERY	
SESB-1	light or dark grey technical fabric	G1 (COM/COL)	12.712 DKK
SESB-2		G2	14.992 DKK
SESB-3		G3	17.755 DKK
SESB-4		G4	20.916 DKK
SESB-5		G5	24.705 DKK

Module C open

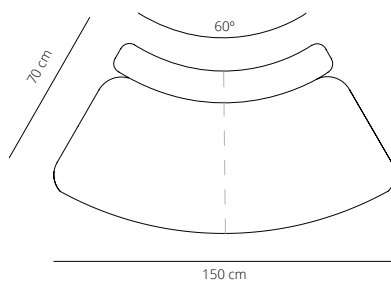

42 kg
(x1) 154x85x79cm (1.03 m³)

CODE	FINISHES		PUBLIC PRICE
	UPHOLSTERY PROTECTION	UPHOLSTERY	
SESC-1	light or dark grey technical fabric	G1 (COM/COL)	12.204 DKK
SESC-2		G2	14.374 DKK
SESC-3		G3	17.026 DKK
SESC-4		G4	20.035 DKK
SESC-5		G5	23.611 DKK

SUGGESTIONS

Composition 1

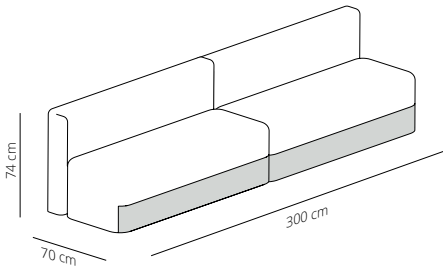

CODE	FINISHES	PUBLIC PRICE
COMPOSITION 1	G1 (COM/COL)	21.187 DKK
	G2	25.001 DKK
	G3	29.476 DKK
	G4	34.866 DKK
	G5	41.104 DKK

Components: 2 x SESA

Composition 2

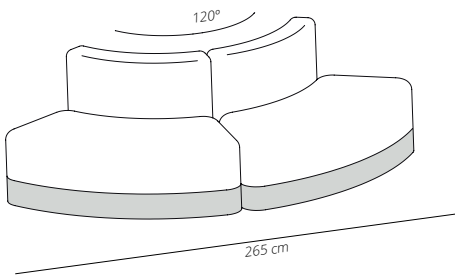

CODE	FINISHES	PUBLIC PRICE
COMPOSITION 2	G1 (COM/COL)	24.408 DKK
	G2	28.747 DKK
	G3	34.053 DKK
	G4	40.070 DKK
	G5	47.223 DKK

Components: 2 x SESC

Composition 3

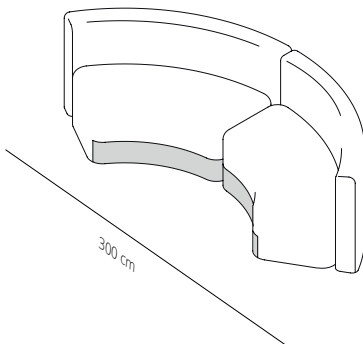

CODE	FINISHES	PUBLIC PRICE
COMPOSITION 3	G1 (COM/COL)	25.425 DKK
	G2	29.985 DKK
	G3	35.510 DKK
	G4	41.833 DKK
	G5	49.409 DKK

Components: 2 x SESB

Season Sofa

2017, BY PIERO LISSONI

SOFAS

Composition 4

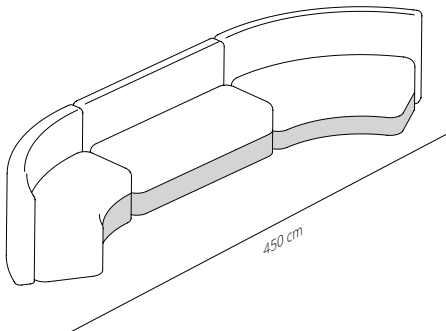

CODE	FINISHES	PUBLIC PRICE
COMPOSITION 4	G1 (COM/COL)	36.019 DKK
	G2	42.485 DKK
	G3	50.248 DKK
	G4	59.266 DKK
	G5	69.961 DKK

Components: 1 x SESA
2 x SESB

Composition 5

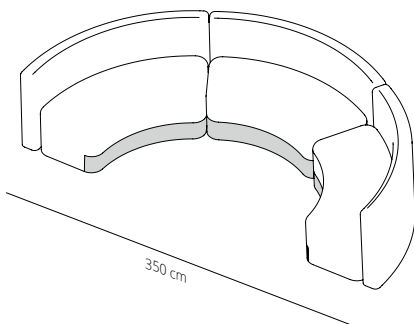

CODE	FINISHES	PUBLIC PRICE
COMPOSITION 5	G1 (COM/COL)	38.137 DKK
	G2	44.977 DKK
	G3	53.265 DKK
	G4	62.749 DKK
	G5	74.114 DKK

Components: 3 x SESB

Composition 6

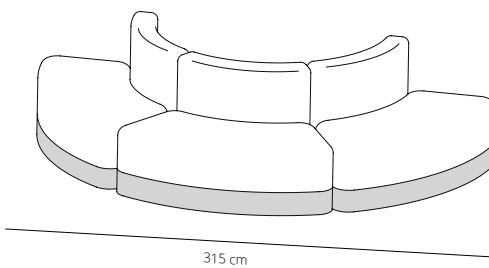

CODE	FINISHES	PUBLIC PRICE
COMPOSITION 6	G1 (COM/COL)	36.612 DKK
	G2	43.121 DKK
	G3	51.079 DKK
	G4	60.105 DKK
	G5	70.834 DKK

Components: 3 x SESC

Composition 7

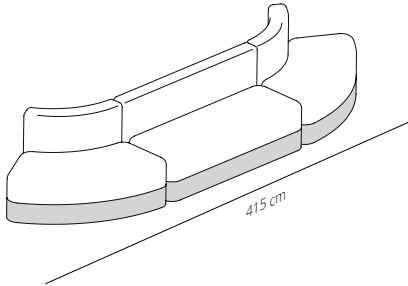

CODE	FINISHES	PUBLIC PRICE
COMPOSITION 7	G1 (COM/COL)	35.002 DKK
	G2	41.248 DKK
	G3	48.791 DKK
	G4	57.503 DKK
	G5	67.775 DKK

Components: 1 x SESA
2 x SESC

Composition 8

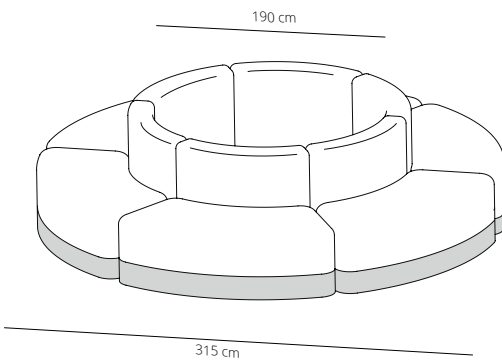

CODE	FINISHES	PUBLIC PRICE
COMPOSITION 8	G1 (COM/COL)	73.224 DKK
	G2	86.242 DKK
	G3	102.158 DKK
	G4	120.209 DKK
	G5	141.668 DKK

Components: 6 x SESC

CUSHIONS

Cushions made of 100% siliconized high performance microfiber with anti-dust mite treatment.

Cushion 60x30

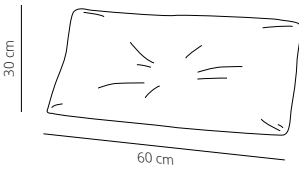

1.2 kg
 (x1) 60x42x16 cm (0.04 m³)

CODE	FINISHES	PUBLIC PRICE
SESAL30-1	G1 (COM/COL)	415 DKK
SESAL30-2	G2	525 DKK
SESAL30-3	G3	729 DKK
SESAL30-4	G4	1.195 DKK
SESAL30-5	G5	1.458 DKK

Cushion 50x50

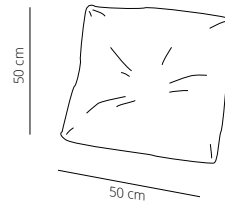

2 kg
 (x1) 53x53x21 cm (0.06 m³)

Needed fabric for material
 1.40 m wide:
 Cushion 60x30: 0.35 m
 Cushion 50x50: 0.55 m

CODE	FINISHES	PUBLIC PRICE
SESAL50-1	G1 (COM/COL)	525 DKK
SESAL50-2	G2	670 DKK
SESAL50-3	G3	1.034 DKK
SESAL50-4	G4	1.610 DKK
SESAL50-5	G5	1.864 DKK

POWER OPTIONS

Built-in SCHUKO/USB powerbox

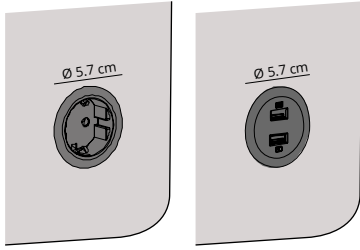

1 kg

Included and installed in the sofa

CODE	FINISHES	PUBLIC PRICE
SESELE	black	831 DKK
SESELUA		1.144 DKK

SESELE: Built-in Schuko socket powerbox for device charging.
Dimensions: Ø 5.7 cm

SESELUA: Built-in double USB hub for device charging.
Dimensions: Ø 5.7 cm

The powerbox has a Wieland connector. The power connection cable is not included, and will have to be provided by the customer.

Built-in powerbox

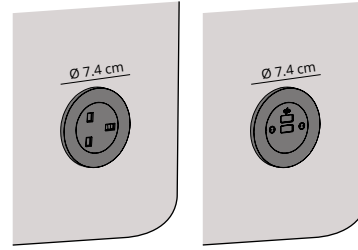

1 kg

Included and installed in the sofa

CODE	FINISHES	PUBLIC PRICE
SESELO	black	1.144 DKK
SESELUC		2.390 DKK

SESELO*: Built-in powerbox with multiple country socket connections available.

Dimensions: Ø 7.4 cm

SESELUC: Built-in double USB-A + USB-C hub for device charging.
Dimensions: Ø 7.4 cm

The powerbox has a Wieland connector. The power connection cable is not included, and will have to be provided by the customer.

*For all available power options [see page 505](#).

POWER POSITION OPTIONS

Module A

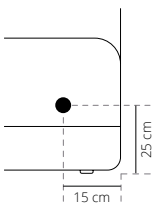
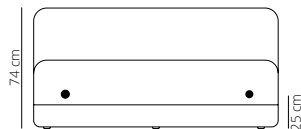
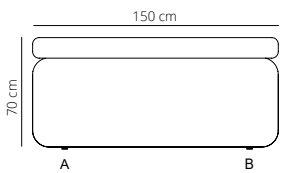

Module B

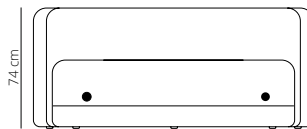
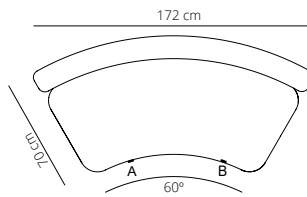

Module C

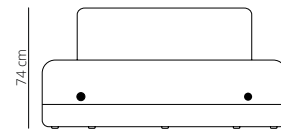
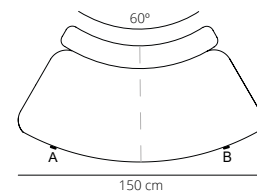

NOTE 1: A and B are references of connection points where the electrification articles can be located, in which up to 1 article can be placed per connection point. Plug and USB options can be combined within the same piece of furniture.

NOTE 2: As the power devices are installed inside the upholstery, a tolerance of 3cm respect the dimensions provided may be expected.



Step

BY VINCENT VAN DUYSSEN

SOFAS

Test certificates: ANSI/BIFMA X5.4-2012 and UNE EN 16139:2013

Step is a collection of seating and benches that allows a wide variety of compositions by combining elements of different dimensions.

Despite its precise and formal geometric design, it is surprisingly comfortable, which makes it perfect for the residential use.

The tolerance of the different elements can be +/- 3 cm.
Cushions made of soft virgin fibre with anti-acarus treatment.

NOTE: A sketch must be included with your order to avoid any sort of misunderstanding. Remember that "right" and "left" are understood from the perspective of the person looking at the object from the front. The more information you include with your order, the lower the possibility of error.

- 1- Interior structure of the arms, back and seat in solid wood.
For the production of this pieces Viccarbe is using wood from certified sustainable forestry sources.
- 2- Woven seat and back structure.
- 3- Expanded polyurethane foam in different densities.
- 4- Polyester fibre covering.
- 5- Fabric.
- 6- Adjustable legs in height.

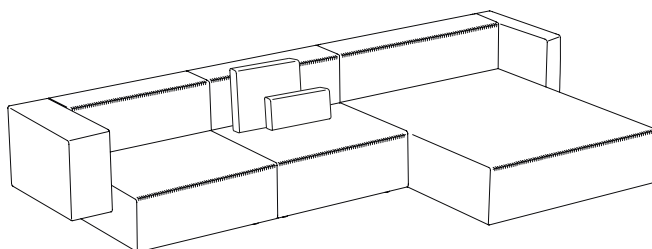
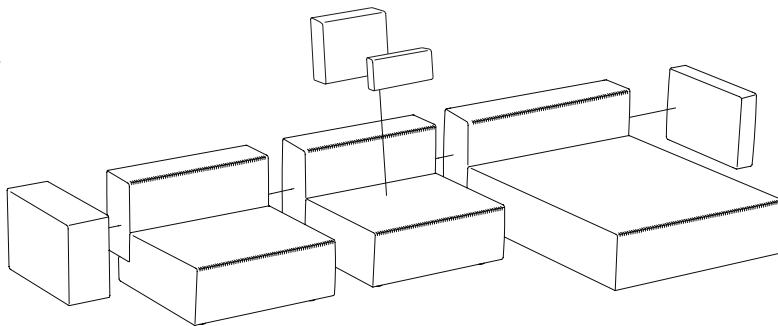
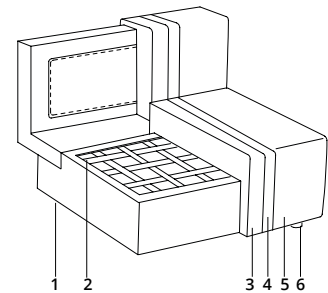
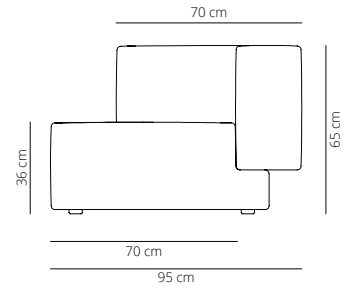

HANDMADE



Seam* colours available: white, black, red, sky blue, light grey, dark grey, green, cream, deep blue, caramel and wine.

**Decorative seams are handmade*

LOUNGE CHAIR SUGGESTIONS

Composition 1

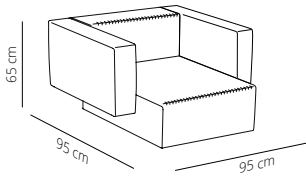

CODE	FINISHES	PUBLIC PRICE	
		WITH SEAM	WITHOUT SEAM
ARMCHAIR COMPOSITION 1	G1 (COM/COL)	12.407 DKK	11.585 DKK
	G2	13.229 DKK	12.458 DKK
	G3	15.221 DKK	14.289 DKK
	G4	18.594 DKK	17.458 DKK
	G5	22.171 DKK	20.815 DKK

Components: 1 x ST70
2 x STWA

Composition 2

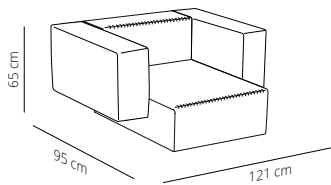

CODE	FINISHES	PUBLIC PRICE	
		WITH SEAM	WITHOUT SEAM
ARMCHAIR COMPOSITION 2	G1 (COM/COL)	12.933 DKK	12.111 DKK
	G2	13.348 DKK	12.577 DKK
	G3	15.509 DKK	14.577 DKK
	G4	18.899 DKK	17.764 DKK
	G5	22.476 DKK	21.120 DKK

Components: 1 x ST70
2 x STTA

Composition 3

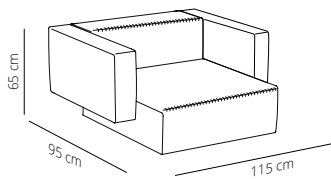

CODE	FINISHES	PUBLIC PRICE	
		WITH SEAM	WITHOUT SEAM
ARMCHAIR COMPOSITION 3	G1 (COM/COL)	14.018 DKK	13.094 DKK
	G2	15.001 DKK	14.009 DKK
	G3	17.196 DKK	16.102 DKK
	G4	21.035 DKK	19.738 DKK
	G5	25.179 DKK	23.518 DKK

Components: 1 x ST90
2 x STWA

Composition 4

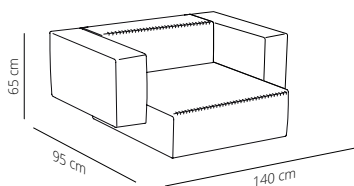

CODE	FINISHES	PUBLIC PRICE	
		WITH SEAM	WITHOUT SEAM
ARMCHAIR COMPOSITION 4	G1 (COM/COL)	14.543 DKK	13.619 DKK
	G2	15.119 DKK	14.128 DKK
	G3	17.484 DKK	16.391 DKK
	G4	21.340 DKK	20.043 DKK
	G5	25.484 DKK	23.823 DKK

Components: 1 x ST90
2 x STTA

SOFA SUGGESTIONS

All of the options may or may not have armrests and it is also possible to combine Wide and Narrow armrest in the same composition.
Please specify the armrests you have chosen in your order.

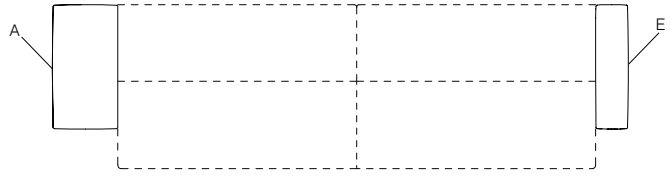

Composition 1

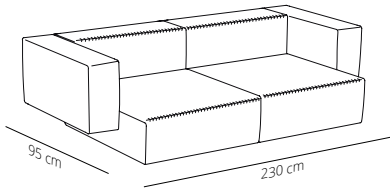

CODE	FINISHES	PUBLIC PRICE	
		WITH SEAM	WITHOUT SEAM
SOFA COMPOSITION 1	G1 (COM/COL)	24.713 DKK	22.866 DKK
	G2	25.866 DKK	23.883 DKK
	G3	29.476 DKK	27.289 DKK
	G4	36.239 DKK	33.646 DKK
	G5	43.595 DKK	40.273 DKK

Components: 2 x STTA
2 x ST90

Composition 2

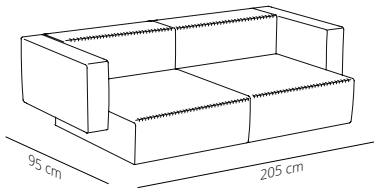

CODE	FINISHES	PUBLIC PRICE	
		WITH SEAM	WITHOUT SEAM
SOFA COMPOSITION 2	G1 (COM/COL)	24.188 DKK	22.340 DKK
	G2	25.747 DKK	23.764 DKK
	G3	29.188 DKK	27.001 DKK
	G4	35.934 DKK	33.341 DKK
	G5	43.290 DKK	39.968 DKK

Components: 2 x STWA
2 x ST90

Composition 3

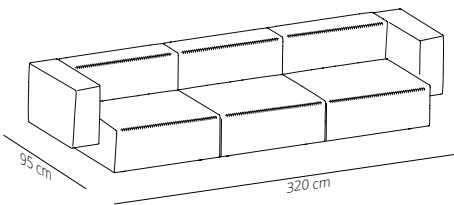

CODE	FINISHES	PUBLIC PRICE	
		WITH SEAM	WITHOUT SEAM
SOFA COMPOSITION 3	G1 (COM/COL)	34.883 DKK	32.112 DKK
	G2	36.612 DKK	33.637 DKK
	G3	41.468 DKK	38.188 DKK
	G4	51.138 DKK	47.248 DKK
	G5	61.706 DKK	56.723 DKK

Components: 2 x STTA
3 x ST90

Composition 4

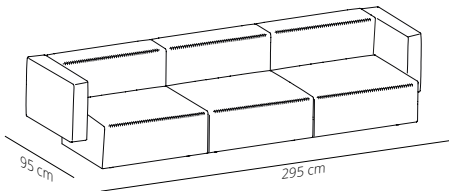

CODE	FINISHES	PUBLIC PRICE	
		WITH SEAM	WITHOUT SEAM
SOFA COMPOSITION 4	G1 (COM/COL)	34.358 DKK	31.586 DKK
	G2	36.493 DKK	33.519 DKK
	G3	41.180 DKK	37.900 DKK
	G4	50.833 DKK	46.943 DKK
	G5	61.401 DKK	56.418 DKK

Components: 2 x STWA
3 x ST90

Composition 5

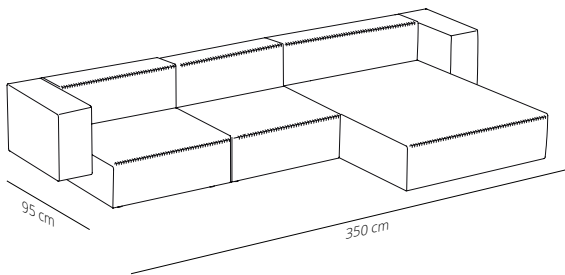

CODE	FINISHES	PUBLIC PRICE	
		WITH SEAM	WITHOUT SEAM
SOFA COMPOSITION 5	G1 (COM/COL)	40.070 DKK	36.824 DKK
	G2	42.163 DKK	38.671 DKK
	G3	47.646 DKK	43.799 DKK
	G4	58.918 DKK	54.248 DKK
	G5	71.004 DKK	65.190 DKK

Components: 1 x STCH
2 x STTA
2 x ST90

Composition 6

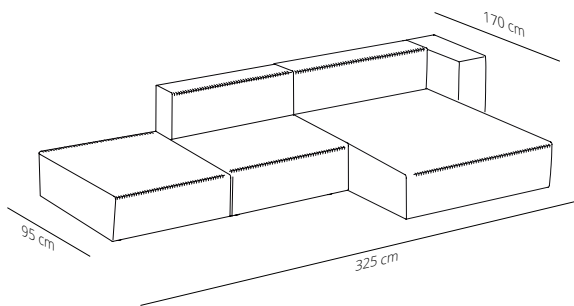

CODE	FINISHES	PUBLIC PRICE	
		WITH SEAM	WITHOUT SEAM
SOFA COMPOSITION 6	G1 (COM/COL)	33.637 DKK	30.790 DKK
	G2	35.561 DKK	32.442 DKK
	G3	39.917 DKK	36.544 DKK
	G4	49.570 DKK	45.358 DKK
	G5	59.800 DKK	54.655 DKK

Components: 1 x STTA
1 x STCH
1 x ST90
1 x STPO

Composition 7

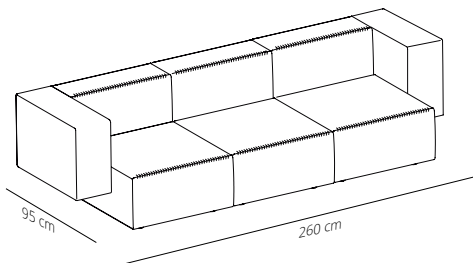

CODE	FINISHES	PUBLIC PRICE	
		WITH SEAM	WITHOUT SEAM
SOFA COMPOSITION 7	G1 (COM/COL)	30.052 DKK	27.586 DKK
	G2	31.298 DKK	28.984 DKK
	G3	35.544 DKK	32.747 DKK
	G4	43.816 DKK	40.409 DKK
	G5	52.681 DKK	48.613 DKK

Components: 2 x STTA
3 x ST70

SOFAS

Composition 8

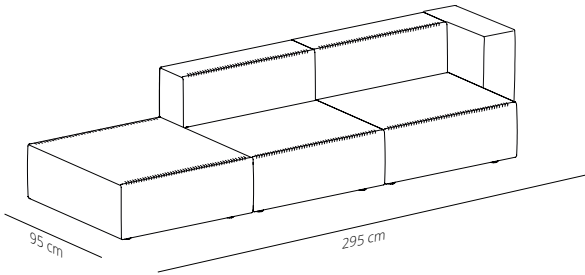

CODE	FINISHES	PUBLIC PRICE	
		WITH SEAM	WITHOUT SEAM
SOFA COMPOSITION 8	G1 (COM/COL)	28.451 DKK	26.078 DKK
	G2	30.010 DKK	27.408 DKK
	G3	33.739 DKK	30.934 DKK
	G4	41.790 DKK	38.358 DKK
	G5	50.503 DKK	46.189 DKK

Components: 1 x STTA
2 x ST90
1 x STPO

Composition 9

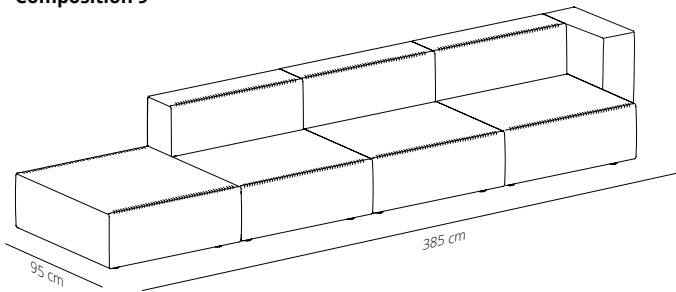

CODE	FINISHES	PUBLIC PRICE	
		WITH SEAM	WITHOUT SEAM
SOFA COMPOSITION 9	G1 (COM/COL)	38.621 DKK	35.324 DKK
	G2	40.756 DKK	37.163 DKK
	G3	45.731 DKK	41.833 DKK
	G4	56.689 DKK	51.960 DKK
	G5	68.614 DKK	62.639 DKK

Components: 1 x STTA
3 x ST90
1 x STPO

Composition 10

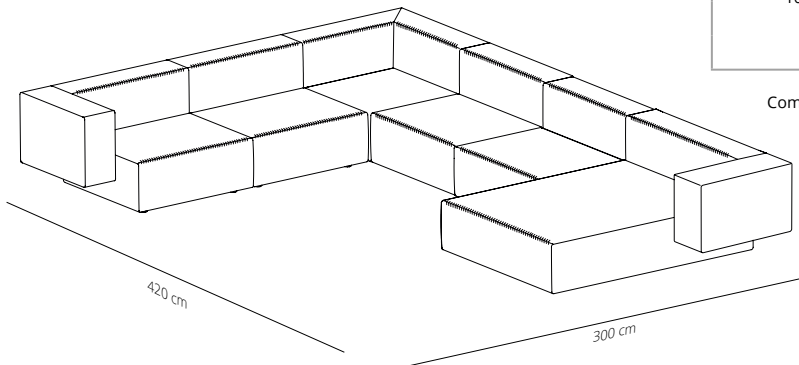

CODE	FINISHES	PUBLIC PRICE	
		WITH SEAM	WITHOUT SEAM
SOFA COMPOSITION 10	G1 (COM/COL)	74.012 DKK	67.673 DKK
	G2	77.978 DKK	71.207 DKK
	G3	87.564 DKK	80.080 DKK
	G4	108.599 DKK	99.513 DKK
	G5	131.303 DKK	119.938 DKK

Components: 1 x STCH
4 x ST90
1 x STRI
2 x STTA

Step

2013, BY VINCENT VAN DUYSSEN

SOFAS

Needed fabric for material
1.40 m wide:
Module 70: 3.4 m
Module 90: 3.4 m

Module 70

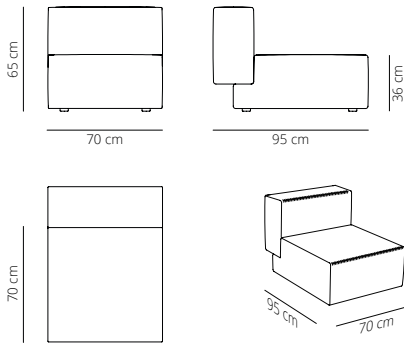

26.7 kg
(x1) 99x74x69cm (0.5 m³)

CODE	FINISHES	PUBLIC PRICE	
		WITH SEAM	WITHOUT SEAM
ST70-1	G1 (COM/COL)	8.560 DKK	7.738 DKK
ST70-2	G2	8.975 DKK	8.204 DKK
ST70-3	G3	10.017 DKK	9.085 DKK
ST70-4	G4	12.458 DKK	11.323 DKK
ST70-5	G5	15.102 DKK	13.746 DKK

Module 90

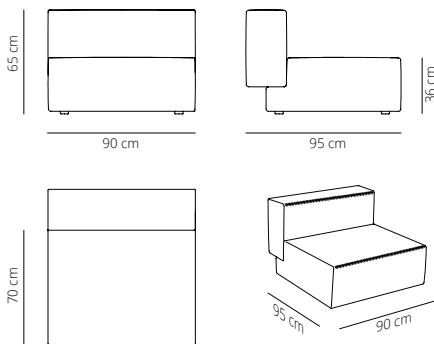

36.5 kg
(x1) 106x95x79cm (0.8 m³)

CODE	FINISHES	PUBLIC PRICE	
		WITH SEAM	WITHOUT SEAM
ST90-1	G1 (COM/COL)	10.170 DKK	9.246 DKK
ST90-2	G2	10.746 DKK	9.755 DKK
ST90-3	G3	11.992 DKK	10.899 DKK
ST90-4	G4	14.899 DKK	13.602 DKK
ST90-5	G5	18.111 DKK	16.450 DKK

SOFAS

Needed fabric for material
1.40 m wide:
Chaise: 5.7 m
Corner: 4.9 m

Chaise

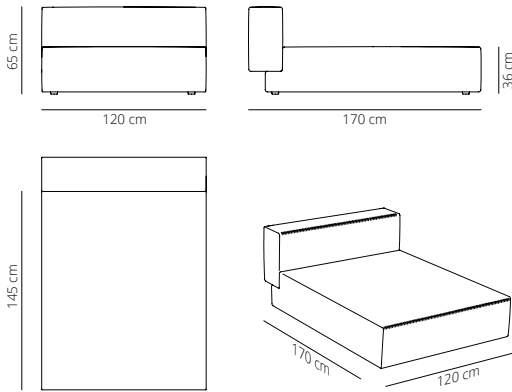

61.4 kg
(x1) 99x74x69cm (0.5 m³)

CODE	FINISHES	PUBLIC PRICE	
		WITH SEAM	WITHOUT SEAM
STCH-1	G1 (COM/COL)	15.357 DKK	13.958 DKK
STCH-2	G2	16.297 DKK	14.789 DKK
STCH-3	G3	18.170 DKK	16.509 DKK
STCH-4	G4	22.679 DKK	20.603 DKK
STCH-5	G5	27.408 DKK	24.916 DKK

Corner

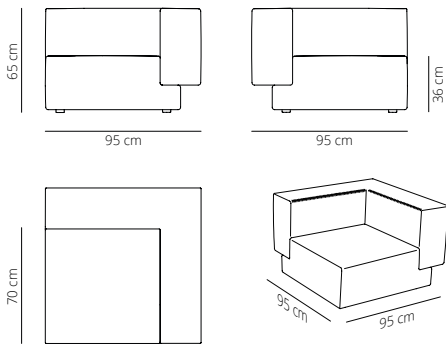

40.9 kg
(x1) 116x103x73cm (0.87 m³)

CODE	FINISHES	PUBLIC PRICE	
		WITH SEAM	WITHOUT SEAM
STRI-1	G1 (COM/COL)	13.602 DKK	12.357 DKK
STRI-2	G2	14.323 DKK	13.026 DKK
STRI-3	G3	15.933 DKK	14.484 DKK
STRI-4	G4	19.882 DKK	18.060 DKK
STRI-5	G5	24.077 DKK	21.849 DKK

Step

2013, BY VINCENT VAN DUYSSEN

SOFAS

Needed fabric for material 1.40 m wide:

Pouf: 1.95 m

Narrow armrest: 1.2 m

Wide armrest: 1.2 m

Pouf

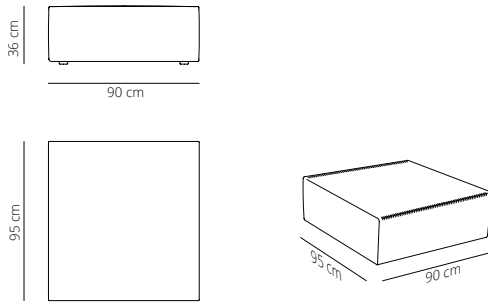

📦 27.3 kg

📦 (x1) 106x95x79cm (0.8 m³)

CODE	FINISHES	PUBLIC PRICE	
		WITH SEAM	WITHOUT SEAM
STPO-1	G1 (COM/COL)	5.924 DKK	5.399 DKK
STPO-2	G2	6.331 DKK	5.712 DKK
STPO-3	G3	7.009 DKK	6.390 DKK
STPO-4	G4	8.772 DKK	7.933 DKK
STPO-5	G5	10.594 DKK	9.602 DKK

Upholstered narrow armrest

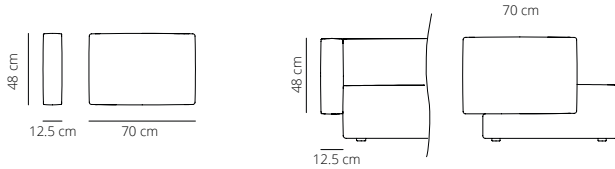

📦 5.75 kg

📦 Installed and included in the box*

*Extra volume for each unit - 0.09m³

CODE		FINISHES	PUBLIC PRICE
RIGHT	LEFT		WITHOUT SEAM
STWAD-1	STWAI-1	G1 (COM/COL)	1.924 DKK
STWAD-2	STWAI-2	G2	2.127 DKK
STWAD-3	STWAI-3	G3	2.602 DKK
STWAD-4	STWAI-4	G4	3.068 DKK
STWAD-5	STWAI-5	G5	3.534 DKK

Upholstered wide armrest

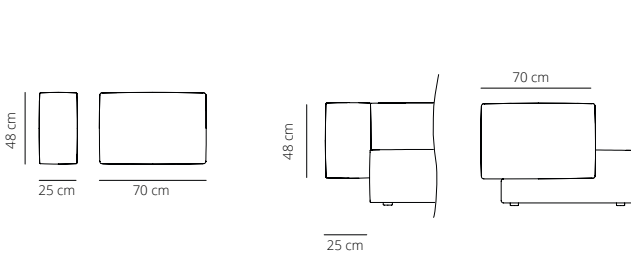

📦 11.5 kg

📦 Installed and included in the box*

*Extra volume for each unit - 0.18m³

CODE		FINISHES	PUBLIC PRICE
RIGHT	LEFT		WITHOUT SEAM
STTAD-1	STTAI-1	G1 (COM/COL)	2.187 DKK
STTAD-2	STTAI-2	G2	2.187 DKK
STTAD-3	STTAI-3	G3	2.746 DKK
STTAD-4	STTAI-4	G4	3.220 DKK
STTAD-5	STTAI-5	G5	3.687 DKK

CUSHIONS

Cushions made of 100% siliconized high performance microfiber with anti-dust mite treatment.

Cushion 60x30

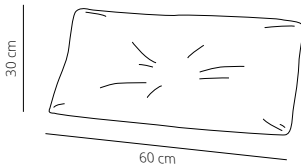

1.2 kg
 (x1) 60x42x16 cm (0.04 m³)

CODE	FINISHES	PUBLIC PRICE
STEAL30-1	G1 (COM/COL)	415 DKK
STEAL30-2	G2	525 DKK
STEAL30-3	G3	729 DKK
STEAL30-4	G4	1.195 DKK
STEAL30-5	G5	1.458 DKK

Cushion 50x50

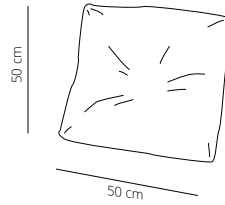

2 kg
 (x1) 53x53x21 cm (0.06 m³)

CODE	FINISHES	PUBLIC PRICE
STEAL50-1	G1 (COM/COL)	525 DKK
STEAL50-2	G2	670 DKK
STEAL50-3	G3	1.034 DKK
STEAL50-4	G4	1.610 DKK
STEAL50-5	G5	1.864 DKK

Needed fabric for material
 1.40 m wide:
 Cushion 60x30: 0.35 m
 Cushion 50x50: 0.55 m

Seat powerbox *NEW*

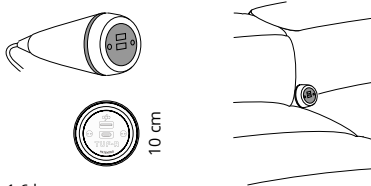

1.6 kg
 (x1) 34x18x9 cm (0.05 m³)

CODE	FINISHES	PUBLIC PRICE
STECON-E	black or white	1.186 DKK
STECON-U		2.424 DKK

Detachable free powerbox between seats.
 STECON-E: Powerbox with one slot for socket.
 STECON-U: Detachable free powerbox with USB - A and a USB - C.
 Dimensions: Ø6.6x15 cm

For all available power options *see page 506*.

The cable length is 0.80 m with Wieland connector. The power connection cable is not included, and will have to be provided by the customer.



Levitt

BY LUDOVICA + ROBERTO PALOMBA

SOFAS

Test certificates: ANSI/BIFMA X5.4-2012 and UNE EN 16139:2013

Levitt is a collection of modular sofas and lounge chairs that allow to multiply compositions and finishes.

The seat depth of the sofa is 90 cm without cushions so do not forget to order the back cushions that you need.
 The direction of the fabric in the chaise lounge and similar sizes options will be the opposite to the side unit to avoid visible sewing.
 The tolerance of the different elements can be +/- 3cm.

Indicate in the order the cushion/back that you would like.
 Cushions in washed duck and goose feather with anti-acarus treatment.
 Anti-feather scape cotton cover.

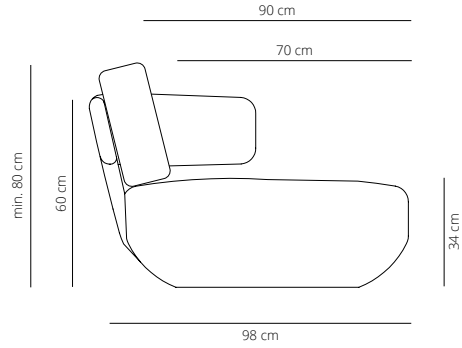

- 1- Interior structure of seat in solid wood. For the production of this pieces Viccarbe is using wood from certified sustainable forestry sources.
- 2- Woven seat structure.
- 3- Structure in plywood with curved back.
- 4- Expanded polyurethane viscoelastic foam in different densities.
- 5- Polyester fibre covering.
- 6- Fabrics or leather.
- 7- Height equalising legs.

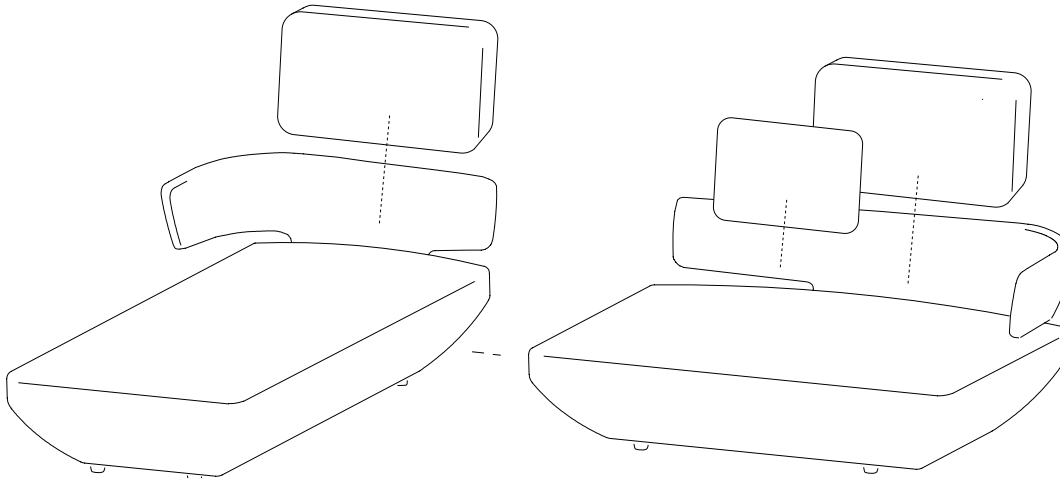
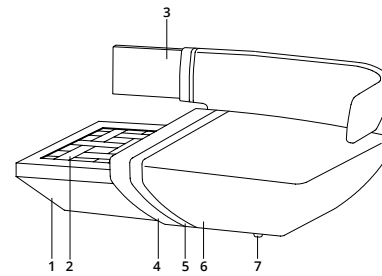

Levitt

2007, BY LUDOVICA + ROBERTO PALOMBA

SOFAS

Test certificates: ANSI/BIFMA X5.4-2012 and UNE EN 16139:2013

Needed fabric for material 1.40 m wide:

Lounge chair: 4.2 m

Sofa 152: 7.6 m

Lounge chair

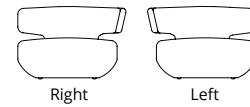
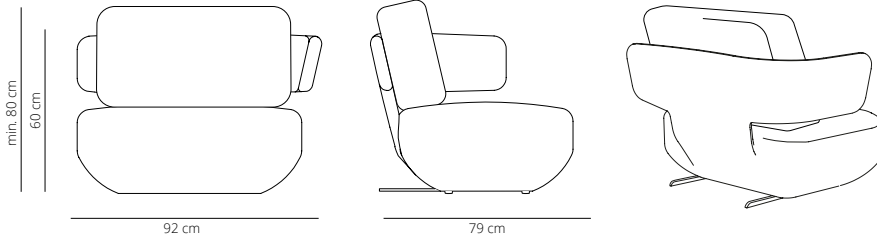

NOTE: The lounge chair will be supplied with a wide right arm (front-on-view); although it can also be made with a wide left arm (in any case it is essential that you provide us with a sketch when making the order so that no mistakes are made). The other models will be supplied with the arm in the position that is shown in each sketch.

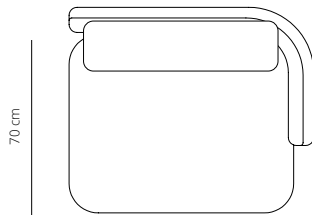

34 kg
(x1) 99x92x65cm (0.59 m³)

CODE		FINISHES	PUBLIC PRICE
ARM RIGHT	ARM LEFT		
BUTACA DCHA	BUTACA IZQD	G1 (T/C)	11.162 DKK
		G2	11.831 DKK
		G3	13.026 DKK
		G4	14.899 DKK
		G5	18.009 DKK

Includes 1 pc. backrest cushion 70x48 cm
Legs are made of calibrated steel with black microtexturized finish.

Sofa 152

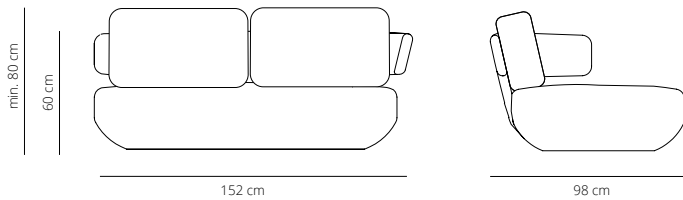

CODE	FINISHES	PUBLIC PRICE
SOFA 152	G1 (T/C)	16.238 DKK
	G2	17.136 DKK
	G3	19.001 DKK
	G4	21.959 DKK
	G5	26.620 DKK

Includes 2 pcs. backrest cushion 70x48 cm

81.2 kg
(x1) 162x98x67cm (1.06 m³)
(x1) 53x15,5x9,5cm (0.01 m³)

SOFAS

Needed fabric for material 1.40 m wide:
Sofa 184: 9.15 m
Sofa 244: 11.6 m

Sofa 184

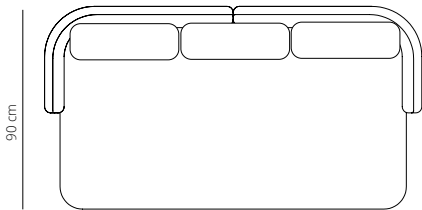
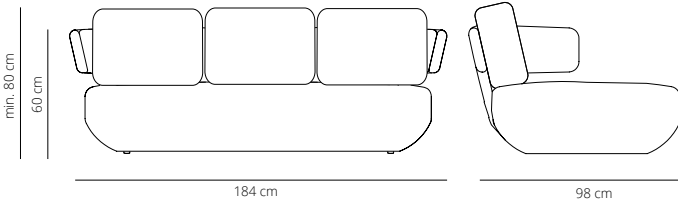

81.5 kg
 (x1) 190x98x67cm (1.24 m³)
 (x1) 53x15,5x9,5 (0.01 m³)

CODE	FINISHES	PUBLIC PRICE
SOFA 184	G1 (T/C)	21.789 DKK
	G2	22.882 DKK
	G3	25.120 DKK
	G4	33.951 DKK
	G5	39.282 DKK

Includes 3 pcs. backrest cushion 55x48 cm.

Sofa 244

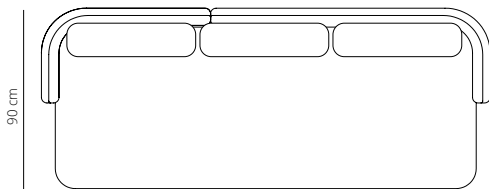
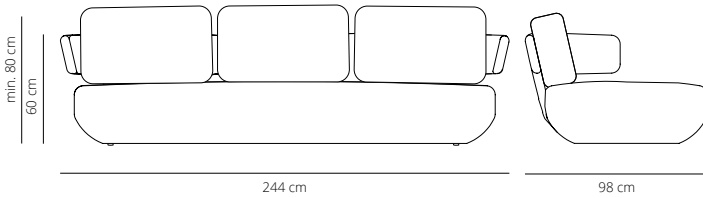

99.5 kg
 (x1) 245x98x67cm (1.61 m³)
 (x1) 53x15,5x9,5cm (0.01 m³)

CODE	FINISHES	PUBLIC PRICE
SOFA 244	G1 (T/C)	26.934 DKK
	G2	28.391 DKK
	G3	31.603 DKK
	G4	36.171 DKK
	G5	43.748 DKK

Includes 3 pcs. backrest cushion 70x48 cm

Levitt

2007, BY LUDOVICA + ROBERTO PALOMBA

SOFAS

Needed fabric for material 1.40
m wide:
Chaise: 6.1 m

Chaise

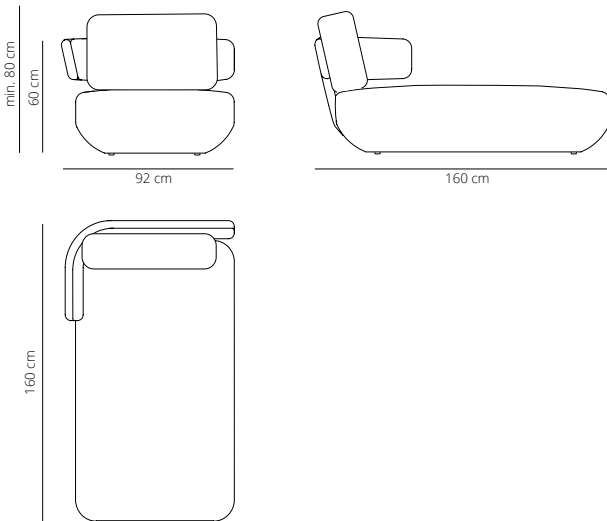

47 kg
(x1) 165x98x67 (1.08 m³)

CODE	FINISHES	PUBLIC PRICE
CHAISE	G1 (T/C)	13.602 DKK
	G2	14.323 DKK
	G3	15.823 DKK
	G4	17.959 DKK
	G5	21.637 DKK

Includes 1 pc. backrest cushion 70x48 cm

Composition L1

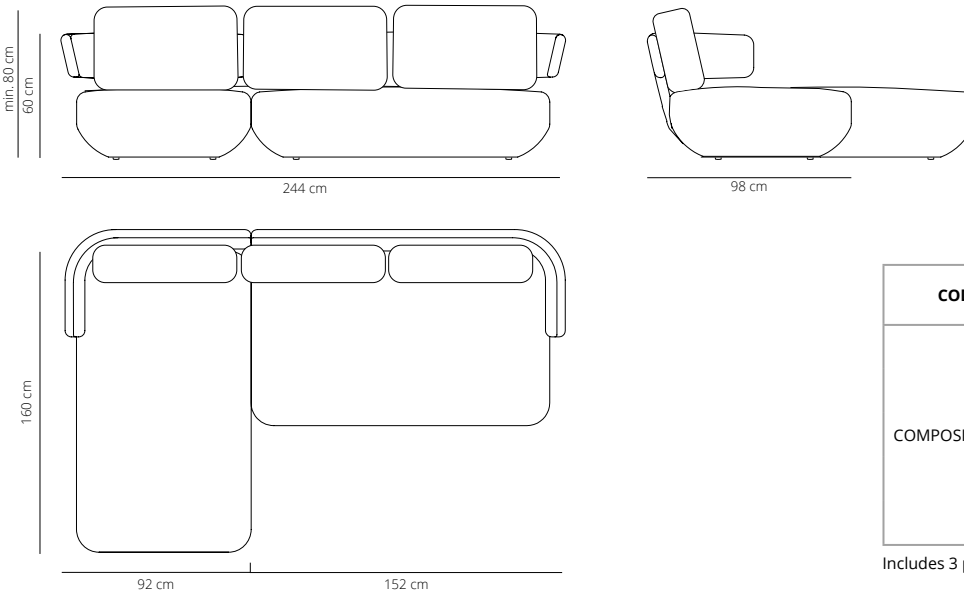

128.2 kg
(x1) 165x98x67 (1.08 m³)
(x1) 162x98x67cm (1.06 m³)
(x1) 53x15,5x9,5cm (0.01 m³)

CODE	FINISHES	PUBLIC PRICE
COMPOSITION L1	G1 (T/C)	29.840 DKK
	G2	31.459 DKK
	G3	34.824 DKK
	G4	39.917 DKK
	G5	48.257 DKK

Includes 3 pcs. backrest cushion 70x48 cm

CUSHIONS

Cushions made of 100% siliconized high performance microfiber with anti-dust mite treatment.

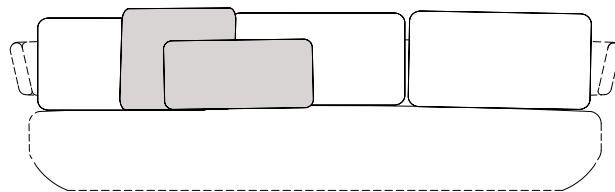

Cushion 60x30



📦 1.2 kg
 📦 (x1) 60x42x16 cm (0.04 m³)

CODE	FINISHES	PUBLIC PRICE
LEAL30-1	G1 (T/C)	415 DKK
LEAL30-2	G2	525 DKK
LEAL30-3	G3	729 DKK
LEAL30-4	G4	1.195 DKK
LEAL30-5	G5	1.458 DKK

Cushion 50x50

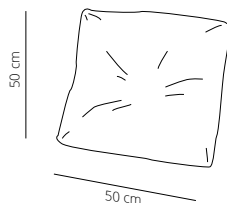

📦 2 kg
 📦 (x1) 53x53x21 cm (0.06 m³)

CODE	FINISHES	PUBLIC PRICE
LEAL50-1	G1 (T/C)	525 DKK
LEAL50-2	G2	670 DKK
LEAL50-3	G3	1.034 DKK
LEAL50-4	G4	1.610 DKK
LEAL50-5	G5	1.864 DKK

Needed fabric for material
 1.40 m wide:

Almohadón 60x30: 0.35 m
 Almohadón 50x50: 0.55 m



Season Bench

BY PIERO LISSONI

BENCHES

Test certificates: UNE EN 16139:13

- 1- Interior structure in solid wood and perforated top of microparticles low in formaldehyde. For the production of this piece Viccarbe is using wood from certified sustainable forestry sources
- 2- Expanded polyurethane foam in different densities.
- 3- Polyester fibre covering.
- 4- Fabric or leather.
- 5- Height adjustment legs.

NOTE: Leather and some technical upholstery models are manufactured with different seams.

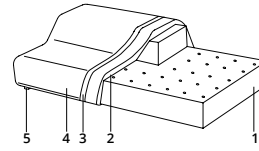

Needed fabric for material
1.40 m wide:
Bench 190: 5.4 m
Bench 250: 7.3 m

Bench 190 cm

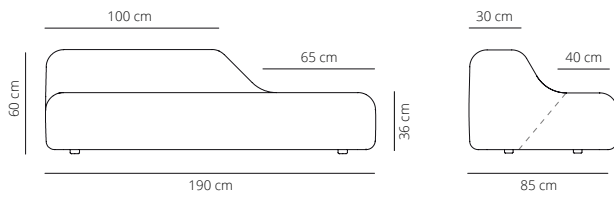

55.4 kg
 (x1) 66x98x192cm (1.24 m³)

CODE		FINISHES	PUBLIC PRICE
RIGHT	LEFT		
SE190D-1	SE190I-1	G1 (COM/COL)	16.967 DKK
SE190D-2	SE190I-2	G2	17.806 DKK
SE190D-3	SE190I-3	G3	19.560 DKK
SE190D-4	SE190I-4	G4	23.501 DKK
SE190D-5	SE190I-5	G5	25.900 DKK

Bench 250 cm

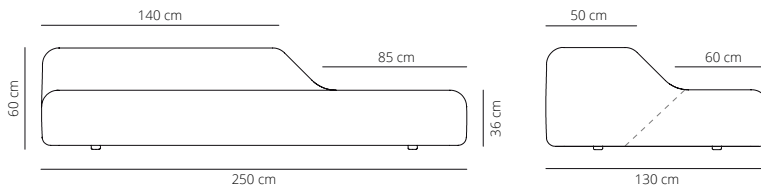

99.8 kg
 (x1) 66x135x256cm (2.28 m³)

CODE		FINISHES	PUBLIC PRICE
RIGHT	LEFT		
SE250D-1	SE250I-1	G1 (COM/COL)	21.018 DKK
SE250D-2	SE250I-2	G2	22.052 DKK
SE250D-3	SE250I-3	G3	24.289 DKK
SE250D-4	SE250I-4	G4	29.112 DKK
SE250D-5	SE250I-5	G5	32.078 DKK

The bench will be provided with the raised part on the right or on the left. Indicate the desired option in the order, remembering that left / right is understood by looking at the element from the front for manufacturing purposes.



POWER OPTIONS

Built-in SCHUKO/USB powerbox

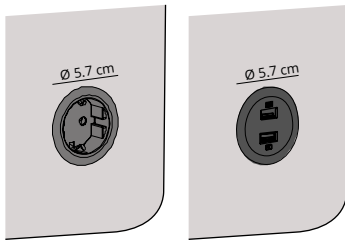

1 kg

Included and installed in the bench

CODE	FINISHES	PUBLIC PRICE
SEBELE	black	831 DKK
SEBELUA		1.144 DKK

SEBELE: Built-in Schuko socket powerbox for device charging.
Dimensions: Ø 5.7 cm

SEBELUA: Built-in double USB hub for device charging.
Dimensions: Ø 5.7 cm

The powerbox has a Wieland connector. The power connection cable is not included, and will have to be provided by the customer.

Built-in powerbox

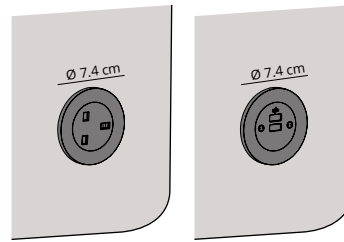

1 kg

Included and installed in the bench

CODE	FINISHES	PUBLIC PRICE
SEBELO	black	1.144 DKK
SEBELUC		2.390 DKK

SEBELO*: Built-in powerbox with multiple country socket connections available
Dimensions: Ø 7.4 cm

SEBELUC: Built-in double USB-A + USB-C hub for device charging
Dimensions: Ø 7.4 cm

The powerbox has a Wieland connector. The power connection cable is not included, and will have to be provided by the customer.

*For all available power options [see page 506](#).

POWER POSITION OPTIONS

Bench 190 cm

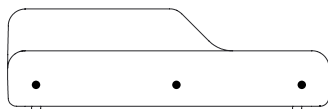
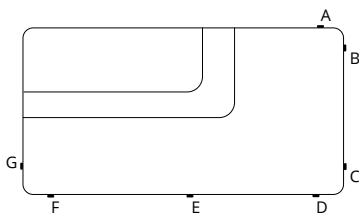

Bench 250 cm

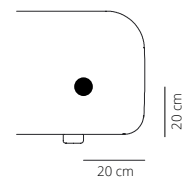
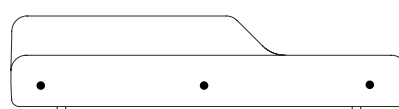
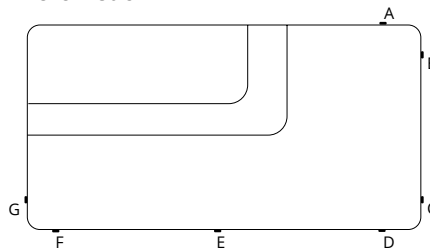

NOTE 1: A, B, C, D, E, F and G are references of connection points where the electrification articles can be located, in which up to 1 article can be placed per connection point. Plug and USB options can be combined within the same piece of furniture.

NOTE 2: As the power devices are installed inside the upholstery, a tolerance of 3cm respect the dimensions provided may be expected.



Torii

BY LUDOVICA + ROBERTO PALOMBA

BENCHES

With its pure and timeless lines, Torii takes both its name and its form from traditional Japanese culture, making reference to the arches, normally found at the entrance to Shinto shrines, that embody the frontier between earthly and sacred matters.

The new bench designed by Ludovica + Roberto Palomba is distinguished by its multifunctionality and use, as it is typically placed in collaborative

spaces and it can also take many different possible finishes (colours, upholstery and electrics).

It can be set to the same height as a chair, which means it can be used next to desks or work tables.



STAINED SEAT AND BACKREST

Structure in calibrated powder coated steel in thermoreinforced polyester in black or white.

Seat and backrest made from natural oak plywood stained with the finishes of our collection.

Black or white injection polypropylene glides.



UPHOLSTERED SEAT AND STAINED BACKREST

Structure in calibrated powder coated steel in thermoreinforced polyester in black or white.

Seat made from plywood covered in non-deformable foamed polyurethane.

Backrest made from curved oak plywood stained with the finishes of our collection.

Black or white injection polypropylene glides.



UPHOLSTERED SEAT AND BACKREST

Structure in calibrated powder coated steel in thermoreinforced polyester in black or white.

Seat and backrest made from plywood covered in non-deformable foamed polyurethane.

Black or white injection polypropylene glides.



STAINED SEAT AND BACKREST WITH CUSHIONS

Structure in calibrated powder coated steel in thermoreinforced polyester in black or white.

Seat and backrest made from natural oak plywood stained with the finishes of our collection.

Seat and backrest cushion made from 5 mm thick MDF covered in non-deformable foamed polyurethane.

There are two cushion models with different widths.

The position of the cushions on the bench is predefined by a series of set configurations *(page 272)*

Test certificates: ANSI/BIFMA X5.4-2012 and UNE-EN 16139:2013 vc 2015

- 1- Structure in calibrated powder coated steel in thermoreinforced polyester in black or white.
- 2- Seat and backrest made from natural oak plywood stained with the finishes of our collection.
- 3- Black or white injection polypropylene glides.

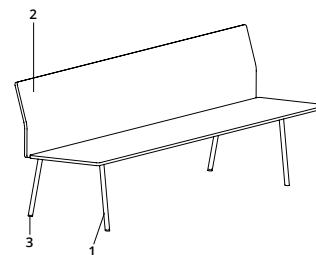

STAINED SEAT AND BACKREST

Bench 140 cm

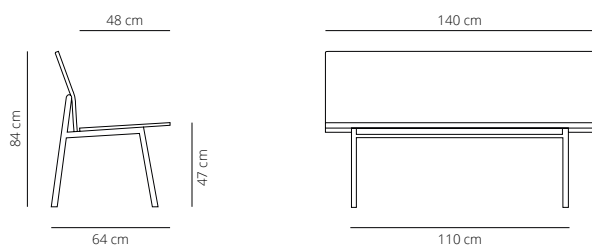

29.4 kg

- (x2) 157x59x10 cm (0.09m³)
- (x1) 141x51x7 cm (0.05m³)
- (x2) 65x62x8 cm (0.03m³)

CODE	FINISHES		PUBLIC PRICE
	STRUCTURE	SEAT AND BACKREST	
TO140RO	black or white	matt oak, cognac, ash, bleached oak or walnut	10.636 DKK

Bench 240 cm

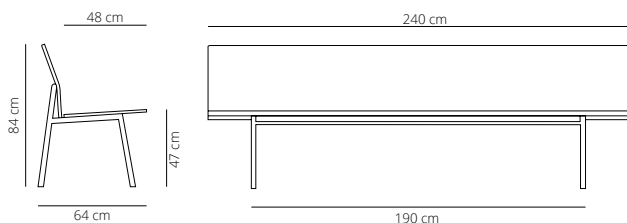

54 kg

- (x2) 252x59x10 cm (0.15m³)
- (x1) 229x51x7 cm (0.08m³)
- (x2) 65x62x8 cm (0.03m³)

CODE	FINISHES		PUBLIC PRICE
	STRUCTURE	SEAT AND BACKREST	
TO240RO	black or white	matt oak, cognac, ash, bleached oak or walnut	15.611 DKK

BENCHES

Test certificates: ANSI/BIFMA X5.4-2012 and UNE-EN 16139:2013 vc 2015

- 1- Structure in calibrated powder coated steel in thermoreinforced polyester in black or white.
- 2- Seat made from plywood covered in non-deformable foamed polyurethane.
- 3- Backrest made from curved oak plywood stained with the finishes of our collection.
- 4- Black or white injection polypropylene glides.

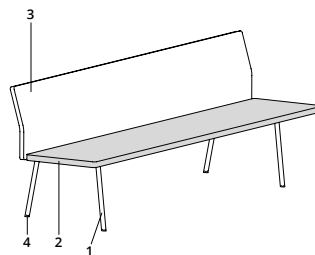

Needed fabric for material 1.40 m wide:
Torii 140: 1.75 m
Torii 240: 2.75 m
Torii 140 leather: 5 m
Torii 240 leather: 10 m

UPHOLSTERED SEAT AND STAINED BACKREST

Bench 140 cm

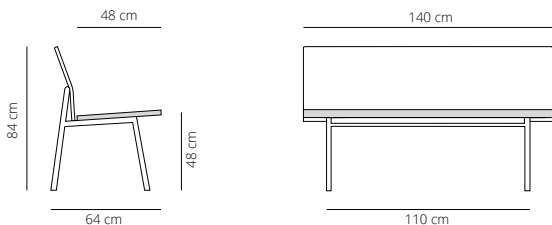

31.5 kg

- (x1) 157x59x10 cm (0.09m³)
- (x1) 155x60x6 cm (0.06m³)
- (x1) 141x51x7 cm (0.05m³)
- (x2) 65x62x8 cm (0.03m³)

CODE	FINISHES			PUBLIC PRICE
	STRUCTURE	BACKREST	SEAT	
TO140AT-1	black or white	matt oak, cognac, ash, bleached oak or walnut	G1 (COM/COL)	10.119 DKK
TO140AT-2			G2	11.323 DKK
TO140AT-3			G3	12.662 DKK
TO140AT-4			G4	14.221 DKK
TO140AT-5			G5	15.891 DKK

Bench 240 cm

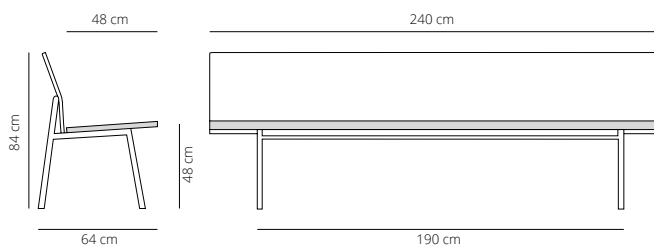

54.8 kg

- (x1) 252x59x10 cm (0.15m³)
- (x1) 252x59x6 cm (0.09m³)
- (x1) 229x51x7 cm (0.08m³)
- (x2) 65x62x8 cm (0.03m³)

CODE	FINISHES			PUBLIC PRICE
	STRUCTURE	BACKREST	SEAT	
TO240AT-1	black or white	matt oak, cognac, ash, bleached oak or walnut	G1 (COM/COL)	14.535 DKK
TO240AT-2			G2	16.297 DKK
TO240AT-3			G3	18.213 DKK
TO240AT-4			G4	20.459 DKK
TO240AT-5			G5	22.882 DKK

NOTE: Benches upholstered in leather have a seam in the center of the seat.

Test certificates: ANSI/BIFMA X5.4-2012 and UNE-EN 16139:2013 vc 2015

- 1- Structure in calibrated powder coated steel in thermoreinforced polyester in black or white.
- 2- Seat and backrest made from plywood covered in non-deformable foamed polyurethane.
- 3- Black or white injection polypropylene glides.

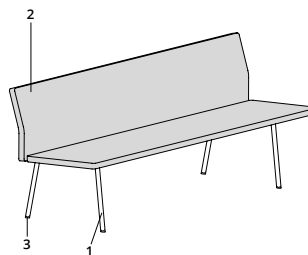

Needed fabric for material
1.40 m wide:
Torii 140: 3.75 m
Torii 240: 5.0 m
Torii 140 leather: 10 m
Torii 240 leather: 20 m

UPHOLSTERED SEAT AND BACKREST

Bench 140 cm

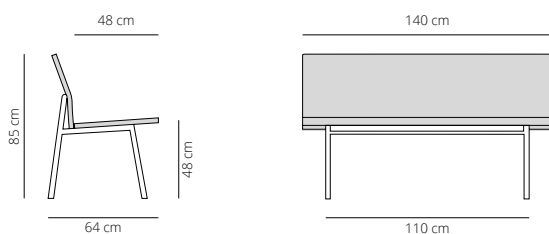

32.6 kg

- (x1) 157x59x10 cm (0.09m³)
- (x1) 155x60x6 cm (0.06m³)
- (x1) 141x51x7 cm (0.05m³)
- (x2) 65x62x8 cm (0.03m³)

CODE	FINISHES		PUBLIC PRICE
	STRUCTURE	SEAT AND BACKREST	
TO140T-1	black or white	G1 (COM/COL)	9.450 DKK
TO140T-2		G2	10.594 DKK
TO140T-3		G3	11.882 DKK
TO140T-4		G4	13.289 DKK
TO140T-5		G5	14.899 DKK

Bench 240 cm

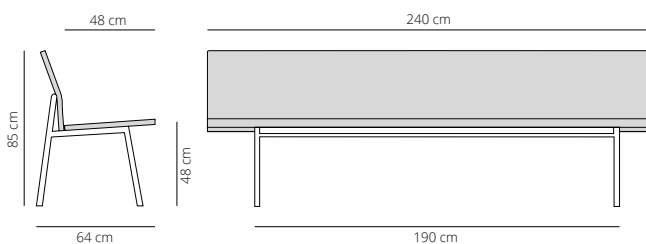

55.4 kg

- (x1) 252x59x10 cm (0.15m³)
- (x1) 252x59x6 cm (0.09m³)
- (x1) 229x51x7 cm (0.08m³)
- (x2) 65x62x8 cm (0.03m³)

CODE	FINISHES		PUBLIC PRICE
	STRUCTURE	SEAT AND BACKREST	
TO240T-1	black or white	G1 (COM/COL)	13.492 DKK
TO240T-2		G2	15.102 DKK
TO240T-3		G3	16.925 DKK
TO240T-4		G4	18.942 DKK
TO240T-5		G5	21.171 DKK

NOTE: Benches upholstered in leather have a seam in the center of the seat and the backrest.

BENCHES

STAINED SEAT AND BACKREST WITH CUSHIONS

The position of the cushions on the bench is predefined by a series of set configurations (see next page).

NOTE: This collection offers the possibility of two-colour upholstery, with one colour for the seat and another for the back. In this case, always calculate based on the price of the fabric in the higher category.

Needed fabric for material
1.40 m wide:
Wide cushion: 0.9 m
Narrow cushion: 0.9 m

Wide cushion for Bench 140 cm

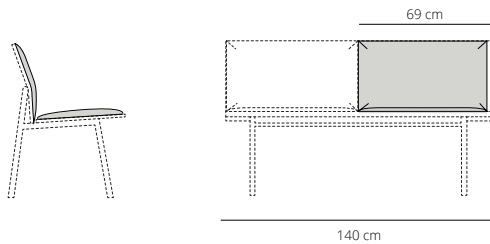

 Installed on the bench.

NOTE: Only for Bench 140 cm

Narrow cushion for Bench 240 cm

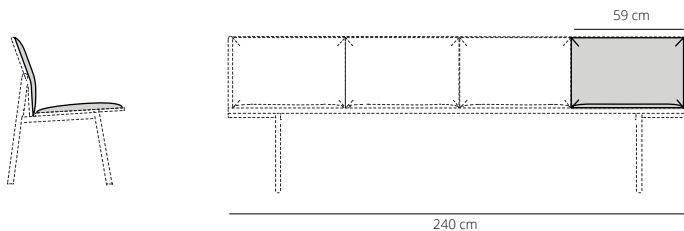

 Installed on the bench.

NOTE: Only for Bench 240 cm

SET CONFIGURATIONS FOR CUSHIONS

Introducing preset configurations for cushion positioning.

Configuration 1

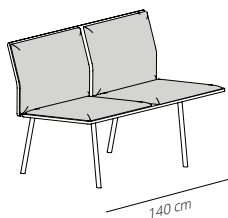

CODE	FINISHES	PUBLIC PRICE
TOCONF1-1	G1 (COM/COL)	14.789 DKK
TOCONF1-2	G2	15.518 DKK
TOCONF1-3	G3	17.077 DKK
TOCONF1-4	G4	18.518 DKK
TOCONF1-5	G5	20.077 DKK

Components: 1 pc. TO140RO
2 pcs. Wide cushion

Configuration 2

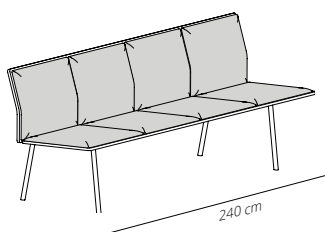

CODE	FINISHES	PUBLIC PRICE
TOCONF2-1	G1 (COM/COL)	23.916 DKK
TOCONF2-2	G2	25.374 DKK
TOCONF2-3	G3	28.493 DKK
TOCONF2-4	G4	31.374 DKK
TOCONF2-5	G5	34.493 DKK

Components: 1 pc. TO240RO
4 pcs. Narrow cushion

Configuration 3

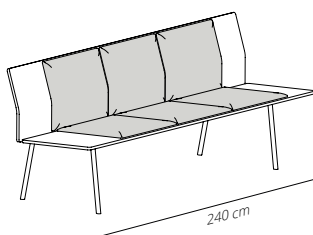

CODE	FINISHES	PUBLIC PRICE
TOCONF3-1	G1 (COM/COL)	21.840 DKK
TOCONF3-2	G2	22.933 DKK
TOCONF3-3	G3	25.272 DKK
TOCONF3-4	G4	27.434 DKK
TOCONF3-5	G5	29.773 DKK

Components: 1 pc. TO240RO
3 pcs. Narrow cushion

Configuration 4

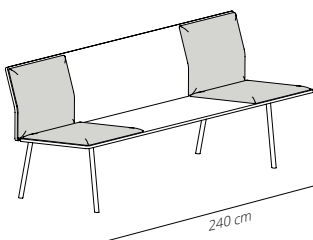

CODE	FINISHES	PUBLIC PRICE
TOCONF4-1	G1 (COM/COL)	19.764 DKK
TOCONF4-2	G2	20.493 DKK
TOCONF4-3	G3	22.052 DKK
TOCONF4-4	G4	23.493 DKK
TOCONF4-5	G5	25.052 DKK

Components: 1 pc. TO240RO
2 pcs. Narrow cushion

BENCHES

Configuration 5

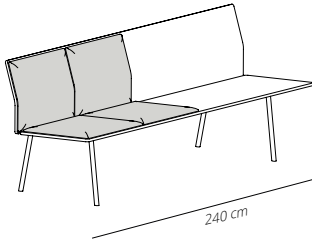

Configuration 6

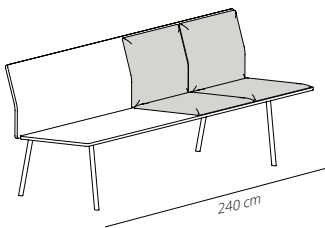

Configuration 7

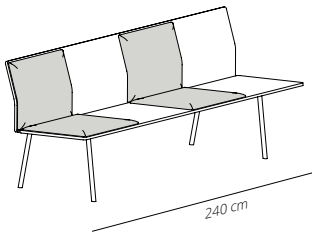

Configuration 8

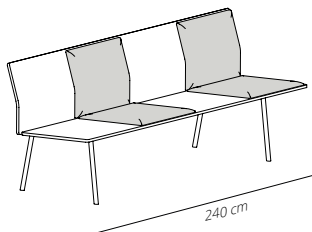

CODE	FINISHES	PUBLIC PRICE
TOCONF5-1	G1 (COM/COL)	19.764 DKK
TOCONF5-2	G2	20.493 DKK
TOCONF5-3	G3	22.052 DKK
TOCONF5-4	G4	23.493 DKK
TOCONF5-5	G5	25.052 DKK

Components: 1 pc. TO240RO
2 pcs. Narrow cushion

CODE	FINISHES	PUBLIC PRICE
TOCONF6-1	G1 (COM/COL)	19.764 DKK
TOCONF6-2	G2	20.493 DKK
TOCONF6-3	G3	22.052 DKK
TOCONF6-4	G4	23.493 DKK
TOCONF6-5	G5	25.052 DKK

Components: 1 pc. TO240RO
2 pcs. Narrow cushion

CODE	FINISHES	PUBLIC PRICE
TOCONF7-1	G1 (COM/COL)	19.764 DKK
TOCONF7-2	G2	20.493 DKK
TOCONF7-3	G3	22.052 DKK
TOCONF7-4	G4	23.493 DKK
TOCONF7-5	G5	25.052 DKK

Components: 1 pc. TO240RO
2 pcs. Narrow cushion

CODE	FINISHES	PUBLIC PRICE
TOCONF8-1	G1 (COM/COL)	19.764 DKK
TOCONF8-2	G2	20.493 DKK
TOCONF8-3	G3	22.052 DKK
TOCONF8-4	G4	23.493 DKK
TOCONF8-5	G5	25.052 DKK

Components: 1 pc. TO240RO
2 pcs. Narrow cushion

POWER OPTIONS

USB hub

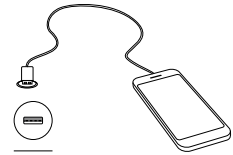

Ø 3cm

Installed and included in the package

CODE	FINISHES	PUBLIC PRICE
TOUSB	black	525 DKK

Built-in USB hub for charging electronic devices.
Available in white or black.

Dimensions: Ø 3 cm

NOTE1: Only available for TO140RO, TO240RO, TOCONF3, TOCONF5, TOCONF6, TOCONF7 and TOCONF8

NOTE2: The bench can be provided with the USB hub on the right or left side. Indicate the desired option in the order, remembering that left / right is understood by looking at the element for manufacturing purposes.



Left

Right

Under seat powerbox

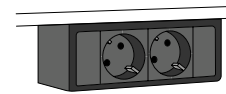

1.7 kg

(x1) 34x18x9cm (0.0055 m³)

CODE	FINISHES	PUBLIC PRICE
TOEL-E	black	2.814 DKK

Powerbox available with two sockets or combined with built-in multimedia devices. Black aluminum frame available.

Dimensions: 16.8x5.4x5.4 cm

For all available power options [see page 506](#).

The cable length is 0.3 meters with Wieland connector. The power connection cable is not included, and will have to be provided by the customer.



Sistema Bench

BY LIEVORE ALTHERR MOLINA

SUGGESTIONS

Composition 1

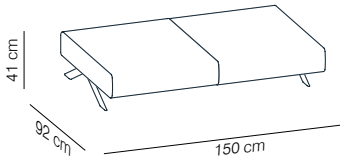

CODE	FINISHES	PUBLIC PRICE	
COMPOSITION 1	smooth upholstery	G1 (T/C)	14.526 DKK
		G2	14.848 DKK
		G3	15.662 DKK
		G4	16.509 DKK
		G5	17.323 DKK
	soft upholstery	G1 (T/C)	16.086 DKK
		G2	16.594 DKK
		G3	17.526 DKK
		G4	18.357 DKK
		G5	19.306 DKK

Components: 2 x SISSRP
2 x SISPTI

Composition 2

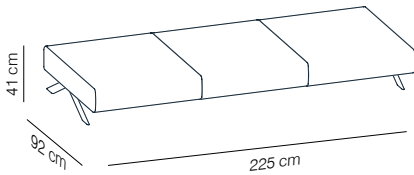

CODE	FINISHES	PUBLIC PRICE	
COMPOSITION 2	smooth upholstery	G1 (T/C)	19.925 DKK
		G2	20.408 DKK
		G3	21.628 DKK
		G4	22.899 DKK
		G5	24.120 DKK
	soft upholstery	G1 (T/C)	22.264 DKK
		G2	23.027 DKK
		G3	24.425 DKK
		G4	25.671 DKK
		G5	27.095 DKK

Components: 3 x SISSRP
2 x SISPTI

Composition 3

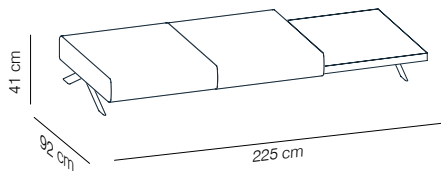

CODE	FINISHES	PUBLIC PRICE	
COMPOSITION 3	smooth upholstery	G1 (T/C)	17.696 DKK
		G2	18.018 DKK
		G3	18.831 DKK
		G4	19.679 DKK
		G5	20.493 DKK
	soft upholstery	G1 (T/C)	19.255 DKK
		G2	19.764 DKK
		G3	20.696 DKK
		G4	21.526 DKK
		G5	22.476 DKK

Components: 2x SISSRP
2 x SISPTI
1 x SISMBTX

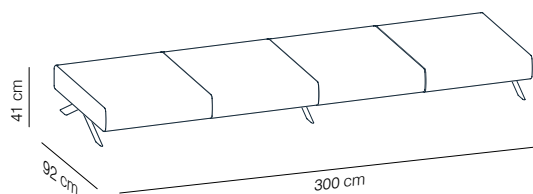
Composition 4

CODE	FINISHES	PUBLIC PRICE	
COMPOSITION 4	smooth upholstery	G1 (T/C)	27.188 DKK
		G2	27.832 DKK
		G3	29.459 DKK
		G4	31.154 DKK
		G5	32.781 DKK
	soft upholstery	G1 (T/C)	30.307 DKK
		G2	31.324 DKK
		G3	33.188 DKK
		G4	34.849 DKK
		G5	36.748 DKK

Components: 4 x SISSRP
3 x SISPTI

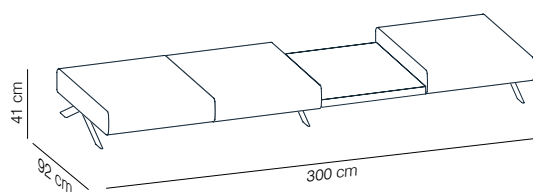
Composition 5

CODE	FINISHES	PUBLIC PRICE	
COMPOSITION 5	smooth upholstery	G1 (T/C)	24.959 DKK
		G2	25.442 DKK
		G3	26.662 DKK
		G4	27.934 DKK
		G5	29.154 DKK
	soft upholstery	G1 (T/C)	27.298 DKK
		G2	28.061 DKK
		G3	29.459 DKK
		G4	30.705 DKK
		G5	32.129 DKK

Components: 3 x SISSRP
3 x SISPTI
1 x SISMBTX

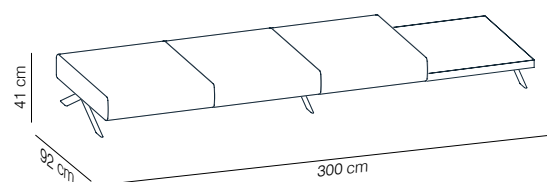
Composition 6

CODE	FINISHES	PUBLIC PRICE	
COMPOSITION 6	smooth upholstery	G1 (T/C)	24.959 DKK
		G2	25.442 DKK
		G3	26.662 DKK
		G4	27.934 DKK
		G5	29.154 DKK
	soft upholstery	G1 (T/C)	27.298 DKK
		G2	28.061 DKK
		G3	29.459 DKK
		G4	30.705 DKK
		G5	32.129 DKK

Components: 3 x SISSRP
3 x SISPTI
1 x SISMBTX

NOTE: The prices are calculated for the table laquered in color group 1 (white, black or grey).

BENCHES

Test certificates: ANSI/BIFMA X5.4:2012 and UNE EN 16139:2013

Frame of calibrated steel base powder coated in thermoreinforced polyester in shadow. Interior structure in steel, solid wood and plywood.

Woven seat and back structure.

Polyester fibre covering. Expanded polyuretane foam in different densities.

Fabric or leather.

Legs.

Needed fabric for material

1.40 m wide:

Legs: 2.90 m

Floor: 2.90 m

MODULES

Legs bench with scissor feet

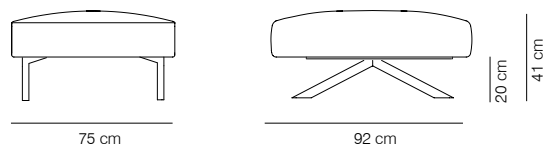

19.6 kg
7.6 kg

(x1) 27.5x96x80cm (0.21 m³)
(x1) 29x83x39.5cm (0.10 m³)

CODE	SCISSOR LEGS	FINISHES	PUBLIC PRICE	
SISSRBP-1	black or white	smooth upholstery	G1 (T/C)	8.458 DKK
SISSRBP-2			G2	8.831 DKK
SISSRBP-3			G3	9.568 DKK
SISSRBP-4			G4	10.306 DKK
SISSRBP-5			G5	11.043 DKK
SISSRBPS-1		soft upholstery	G1 (T/C)	9.178 DKK
SISSRBPS-2			G2	9.416 DKK
SISSRBPS-3			G3	9.848 DKK
SISSRBPS-4			G4	10.229 DKK
SISSRBPS-5			G5	10.670 DKK

19.6 kg (x1) 27.5x96x80cm (0.21 m³)
7.6 kg (x1) 29x83x39.5cm (0.10 m³)

Module Legs

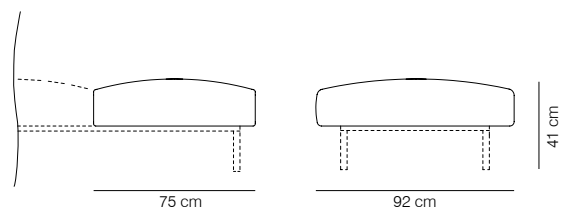

To calculate the volume and number of boxes, please contact the sales department.

*Legs not included in the package or the price

CODE	FINISHES	PUBLIC PRICE	
SISSRP-1	smooth upholstery	G1 (T/C)	5.399 DKK
SISSRP-2		G2	5.560 DKK
SISSRP-3		G3	5.966 DKK
SISSRP-4		G4	6.390 DKK
SISSRP-5		G5	6.797 DKK
SISSRPS-1	soft upholstery	G1 (T/C)	6.178 DKK
SISSRPS-2		G2	6.433 DKK
SISSRPS-3		G3	6.899 DKK
SISSRPS-4		G4	7.314 DKK
SISSRPS-5		G5	7.789 DKK

NOTE: There is no possibility to combine smooth upholstery modules and soft upholstery modules.

Needed fabric for material
1.40 m wide:
Floor: 2.90 m

Module Floor

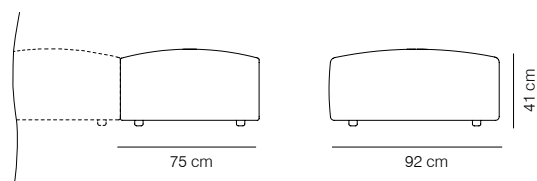

27.8 kg

(x1) 79x98x45cm (0.35 m³)

CODE	FINISHES		PUBLIC PRICE
SISSR-1	smooth upholstery	G1 (T/C)	4.822 DKK
SISSR-2		G2	5.034 DKK
SISSR-3		G3	5.449 DKK
SISSR-4		G4	5.856 DKK
SISSR-5		G5	6.331 DKK
SISSRS-1	soft upholstery	G1 (T/C)	5.509 DKK
SISSRS-2		G2	5.763 DKK
SISSRS-3		G3	6.331 DKK
SISSRS-4		G4	6.797 DKK
SISSRS-5		G5	7.314 DKK

NOTE : Benches with legs must be composed with a minimum of two modules.

LEGS OPTIONS

Scissor legs

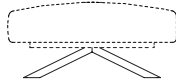

6.6 kg
 (x1) 29x83x39.5cm (0.10 m³)

CODE	FINISHES	PUBLIC PRICE
SISPTI	black or white	1.864 DKK

NOTE: Price per unit.

Calibrated steel tube powder coated with tempered polyester, in the finishes from our collection.

Cylinder legs

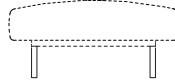

0.6 kg
 (x1) 22x6x10.5cm (0.001 m³)*

*The package contain 2 units.

CODE	FINISHES	PUBLIC PRICE
SISPMET	black or white	1.034 DKK

Calibrated steel tube powder coated with tempered polyester, in the finishes from our collection.

Flute legs

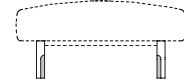

0.4 kg
 (x1) 22x6x10.5cm (0.001 m³)*

*The package contain 2 units.

CODE	FINISHES	PUBLIC PRICE
SISPFL	stained matt oak, cognac, ash, bleached oak or walnut	1.653 DKK

Wooden solid oak legs, with carvings on the sides, stained in the finishes from our collection.**

Upholstered scissor legs

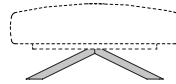

6.6 kg
 (x1) 29x83x39.5cm (0.10 m³)

NOTE: Price per unit.

CODE	FINISHES	PUBLIC PRICE
SISPTTIP	ecoleather	2.746 DKK
SISPTTIL	leather	2.907 DKK

Calibrated steel tube powder coated with tempered polyester and upholstered in leather or ecoleather.

Upholstered cylinder legs

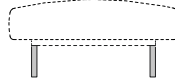

0.6 kg
 (x1) 22x6x10.5cm (0.001 m³)*

*The package contain 2 units.

CODE	FINISHES	PUBLIC PRICE
SISPMETTP	ecoleather	1.500 DKK
SISPMETTL	leather	1.653 DKK

Calibrated steel tube powder coated with tempered polyester and upholstered in leather or ecoleather.



+ 4€

*The price is per each pair of legs

**Felt glides available with an upcharge of 4€.

If not indicated, the chair will be produced with plastic glides.

NOTE: Due to the fact that the wood used is natural, the finish may vary.

TABLE OPTIONS

Low table

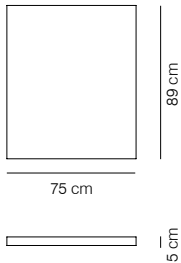

To calculate the volume and number of boxes, please contact the sales department.

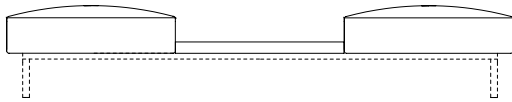

CODE	FINISHES		PUBLIC PRICE
SISMBRO	stained (oak plywood)	matt oak, cognac, ash, bleached oak or walnut	4.204 DKK
SISMBTX	lacquered (MDF)	black or white	3.170 DKK
		taupe, brick, ochre, olive green, dusty pink or dusty green	3.365 DKK

NOTE: Only available for Legs modules

Table in lacquered microtexturized MDF or stained oak plywood with the finishes from our collection.

Wooden box table

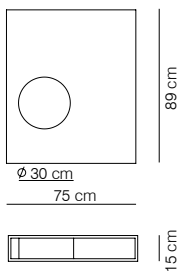

To calculate the volume and number of boxes, please contact the sales department.

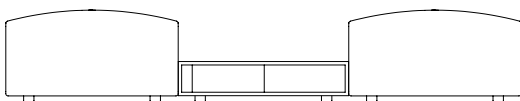
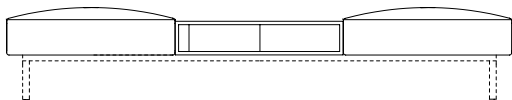

CODE		FINISHES			PUBLIC PRICE
LEGS	FLOOR	CYLINDER	EXTERIOR		
SISMPRO	SISMCRO	white, black, taupe, brick, ochre, olive green, dusty pink, dusty green or bronze	stained oak	matt oak	9.916 DKK
				cognac, ash, bleached oak or walnut	11.365 DKK
SISMPCTX	SISMCTX		lacquered	white or black*	6.543 DKK
				taupe, brick, ochre, olive green, dusty pink or dusty green	7.060 DKK

Table with a stained European oak plywood or lacquered microtexturized MDF tabletop in the finishes from our collection. Interior plywood cylinder lacquered with the finishes from our collection.

ACCESSORIES

Needed fabric for material
1.40 m wide:
Free armrest: 0.85 m

Free table

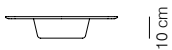
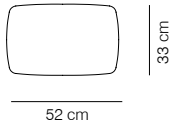

2.8 kg
(x1) 16x60x41cm (0.04 m³)

CODE	FINISHES		PUBLIC PRICE
SISMARO	stained	matt oak, cognac, ash, bleached oak or walnut	1.559 DKK
SISMATX	lacquered	black or white	1.559 DKK
		taupe, brick, ochre, olive green, dusty pink or dusty green	1.712 DKK
		bronze	1.864 DKK

Table with a stained European oak plywood or lacquered microtexturized MDF tabletop in the finishes from our collection.
NOTE: Due to the fact that the wood used is natural, the finish may vary.

Free armrest

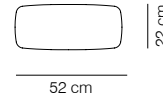

2.6 kg
(x1) 23x60x41 cm (0.06m³)

CODE	FINISHES	0	PUBLIC PRICE
SISBRA-1	upholstered	G1 (T/C)	0 DKK 4.509 DKK
SISBRA-2		G2	0 DKK 4.619 DKK
SISBRA-3		G3	0 DKK 4.822 DKK
SISBRA-4		G4	0 DKK 5.085 DKK
SISBRA-5		G5	0 DKK 5.288 DKK

Upholstered armrest with MDF structure, lacquered in black with expanded nondeformable polyurethane foam, of different densities and polyester fibre.

Underseat powerbox

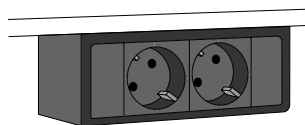

1.7 kg
(x1) 34X18X9cm (0.0055 m³)

CODE	FINISHES	PUBLIC PRICE
SISEL-E	black	2.814 DKK

Powerbox available with two sockets or combined with built-in multimedia devices.
Dimensions: 16.8x5.4x5.4 cm

For all available power options *see page 505*.

The cable length is 0.3 meters with Wieland connector. The power connection cable is not included, and will have to be provided by the customer.

USB hub

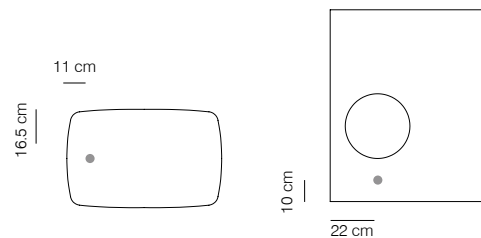
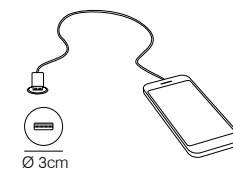

(x1) 16x60x41cm (0.04 m³)

CODE	FINISHES	PUBLIC PRICE
SISUSB	black or white	525 DKK

Built-in USB hub for charging electronic devices. The cable length is 1.0 m with USB connection. Available white or black in the Free table and Wooden box table in the preset positions.
Dimensions: Ø 3 cm



Trestle Bench

BY JOHN PAWSON

BENCHES

Test certificates: ANSI/BIFMA X5.4:2012 and UNE-EN 16139:2013

BENCH

- 1- Inner structure of compact wooden board.
- 2- Expanded polyurethane foam in different densities.
- 3- Fabric or leather. Finish smooth or padded.
- 4- Beam in calibrated powder coated tube in thermoreinforced polyester in graphite grey.
- 5- Legs in solid oak wood with the finishes of our collection. Due to the fact that the wood used is natural, the finish may vary.

NOTE: Due to the fact that the wood used is natural, the finish may vary.

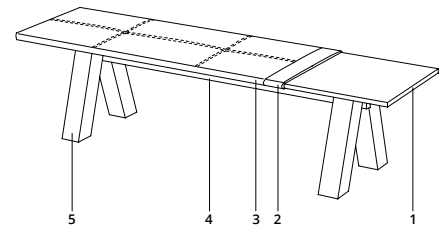

Needed fabric for material 1.40 m wide:

- Trestle simple bench smooth upholstery: 2.20 m
- Trestle double bench smooth upholstery: 3.60 m
- Trestle triple bench smooth upholstery: 5 m

- Trestle simple bench padded upholstery: 2.35 m
- Trestle double bench padded upholstery: 3.75 m
- Trestle triple bench padded upholstery: 5.15 m

BACKREST

- 1- Interior structure in MDF.
- 2- Expanded polyurethane foam.
- 3- Fabric or leather. Finish smooth or padded.

Needed fabric for material 1.40 m wide:

- Trestle central seat L120 smooth upholstery: 1.6 m
- Trestle endseat L150 smooth upholstery: 1.9 m
- Trestle simple seat L180 smooth upholstery: 2.2 m

- Trestle central seat L120 padded upholstery: 1.75 m
- Trestle endseat L150 padded upholstery: 2.05 m
- Trestle simple seat L180 padded upholstery: 2.4 m

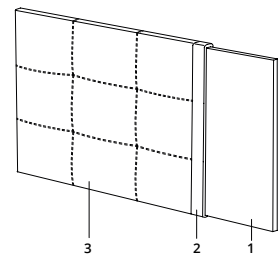

FINISHING OPTIONS:

Padded

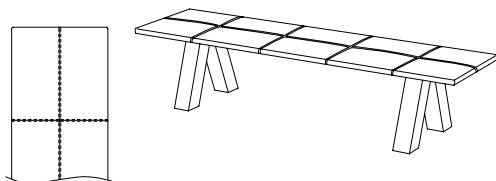

Smooth

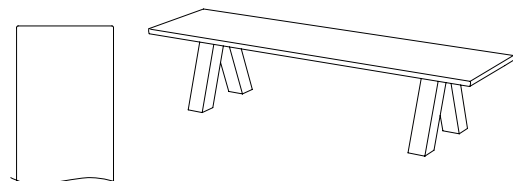

Trestle Bench

2014, BY JOHN PAWSON

BENCHES

Simple bench smooth or padded upholstery

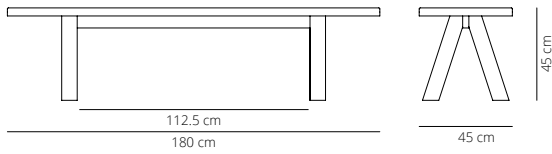

CODE	FINISHES		PUBLIC PRICE	
	LEGS	UPHOLSTERY		
TRSL-1	stained (oak): matt oak, cognac, ash, bleached oak or walnut	smooth	G1 (COM/COL)	10.382 DKK
TRSL-2			G2	10.848 DKK
TRSL-3			G3	11.882 DKK
TRSL-4			G4	12.865 DKK
TRSL-5			G5	13.916 DKK
TRSC-1	lacquered microtexturized (beech): white, black or taupe	padded	G1 (COM/COL)	10.746 DKK
TRSC-2			G2	11.212 DKK
TRSC-3			G3	12.204 DKK
TRSC-4			G4	13.187 DKK
TRSC-5			G5	14.068 DKK

32 kg
 (x1) 193x65x8cm (0.10 m³)
 (x1) 46x48x46cm (0.10 m³)
 (x1) 125x6x9cm (0.01 m³)

Double bench smooth or padded upholstery



CODE	FINISHES		PUBLIC PRICE	
	LEGS	UPHOLSTERY		
TRDL-1	stained (oak): matt oak, cognac, ash, bleached oak or walnut	smooth	G1 (COM/COL)	18.009 DKK
TRDL-2			G2	18.840 DKK
TRDL-3			G3	20.391 DKK
TRDL-4			G4	22.052 DKK
TRDL-5			G5	23.713 DKK
TRDC-1	lacquered microtexturized (beech): white, black or taupe	padded	G1 (COM/COL)	18.577 DKK
TRDC-2			G2	19.416 DKK
TRDC-3			G3	21.018 DKK
TRDC-4			G4	22.679 DKK
TRDC-5			G5	24.391 DKK

58.8 kg
 (x2) 165x64x8cm (0.08 m³)
 (x1) 46x48x31cm (0.07 m³)
 (x1) 46x48x46cm (0.10 m³)
 (x2) 125x6x9cm (0.01 m³)

Triple bench smooth or padded upholstery

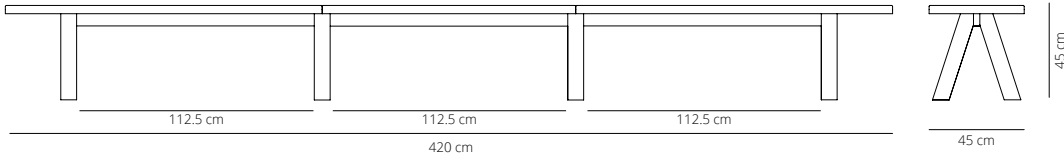

CODE	FINISHES		PUBLIC PRICE	
	LEGS	UPHOLSTERY		
TRTL-1	stained (oak): matt oak, cognac, ash, bleached oak or walnut	smooth	G1 (COM/COL)	24.747 DKK
TRTL-2			G2	25.900 DKK
TRTL-3			G3	28.179 DKK
TRTL-4			G4	30.468 DKK
TRTL-5			G5	32.798 DKK
TRTC-1	lacquered microtexturized (beech): white, black or taupe	padded	G1 (COM/COL)	25.586 DKK
TRTC-2			G2	26.730 DKK
TRTC-3			G3	29.018 DKK
TRTC-4			G4	31.349 DKK
TRTC-5			G5	33.739 DKK

- 75 kg
- (x2) 165x64x8cm (0.08 m³)
- (x1) 134x64x7cm (0.06 m³)
- (x2) 46x48x46cm (0.10 m³)
- (x3) 125x6x9cm (0.01 m³)

BACKREST

Central seat L120 smooth or padded upholstery

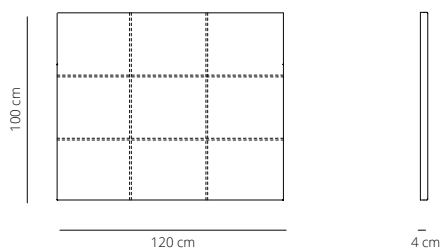

📦 20 kg

📦 (x1) 105x130x10cm (0.13m³)

CODE	FINISHES	PUBLIC PRICE
TRRCL-1	smooth	G1 (COM/COL) 3.534 DKK
TRRCL-2		G2 3.941 DKK
TRRCL-3		G3 4.890 DKK
TRRCL-4		G4 5.814 DKK
TRRCL-5		G5 6.797 DKK
TRRCC-1	padded	G1 (COM/COL) 3.848 DKK
TRRCC-2		G2 4.314 DKK
TRRCC-3		G3 5.297 DKK
TRRCC-4		G4 6.280 DKK
TRRCC-5		G5 7.170 DKK

End seat L150 smooth or padded upholstery

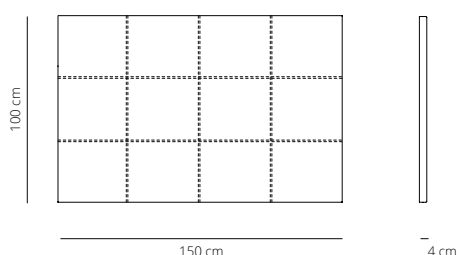

📦 25 kg

📦 (x1) 105x160x10cm (0.16m³)

CODE	FINISHES	PUBLIC PRICE
TRREL-1	smooth	G1 (COM/COL) 3.788 DKK
TRREL-2		G2 4.314 DKK
TRREL-3		G3 5.449 DKK
TRREL-4		G4 6.594 DKK
TRREL-5		G5 7.678 DKK
TRREC-1	padded	G1 (COM/COL) 4.204 DKK
TRREC-2		G2 4.780 DKK
TRREC-3		G3 5.814 DKK
TRREC-4		G4 7.009 DKK
TRREC-5		G5 8.144 DKK

Simple seat L180 smooth or padded upholstery

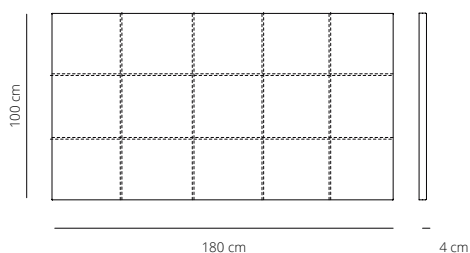

📦 30 kg

📦 (x1) 105x190x10cm (0.19m³)

CODE	FINISHES	PUBLIC PRICE
TRRSL-1	smooth	G1 (COM/COL) 4.051 DKK
TRRSL-2		G2 4.721 DKK
TRRSL-3		G3 5.966 DKK
TRRSL-4		G4 7.314 DKK
TRRSL-5		G5 8.721 DKK
TRRSC-1	padded	G1 (COM/COL) 4.415 DKK
TRRSC-2		G2 5.085 DKK
TRRSC-3		G3 6.433 DKK
TRRSC-4		G4 7.738 DKK
TRRSC-5		G5 9.085 DKK

CUSTOMIZATION

Custom foams and shapes of the backrest are available upon request. If you would like this, please indicate it on the order and attach a sketch.

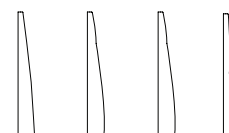

COMPONENTS FOR BENCH COMPOSITIONS

Apart from those suggested, there is a possibility to create your own bench compositions.

For those compositions, it will be necessary to choose two end seats, central seats according to the length of the table, and the legs (the number of legs will be the result of the number of total seats plus 1).

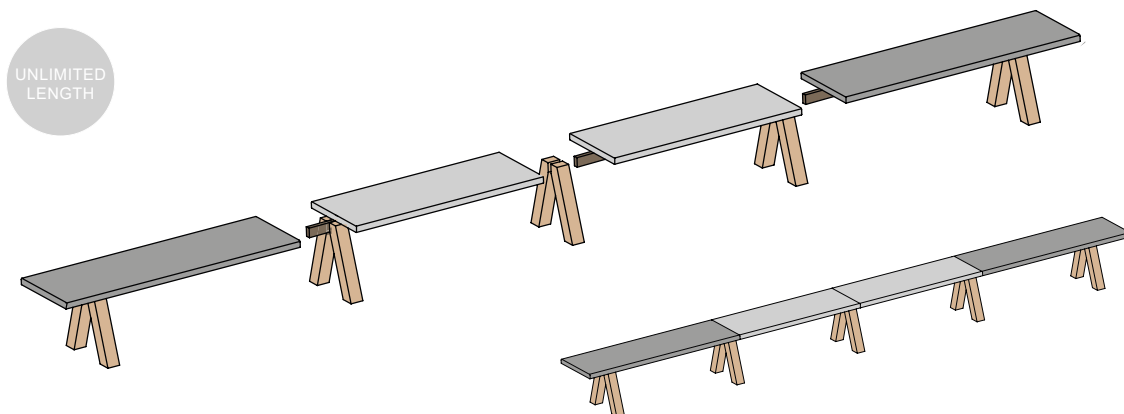

Colour code:

- Central seat
- End seat
- Legs

Needed fabric for material 1.40 m wide:

- Central seat smooth upholstery: 1.60 m
- Central seat padded upholstery: 1.75 m
- End seat smooth upholstery: 1.90 m
- End seat padded upholstery: 2.15 m

Legs



7.2 kg

(x1) 46x48x31cm (0.07m³)

CODE	FINISHES		PUBLIC PRICE
TRP	stained (oak)	matt oak, cognac, ash or wenge	3.110 DKK
	lacquered microtexturized (beech)	white, black or taupe	

Trestle Bench

2014, BY JOHN PAWSON

BENCHES

Central seat L120 smooth or padded upholstery

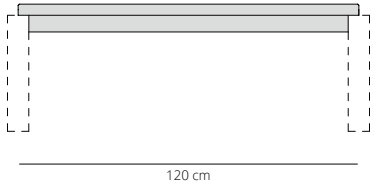

14.3 kg

(x1) 134x64x8cm (0.07m³)
(x1) 125x6x9cm (0.01m³)

CODE	FINISHES	PUBLIC PRICE
TRCL-1	smooth	G1 (COM/COL) 3.576 DKK
TRCL-2		G2 3.898 DKK
TRCL-3		G3 4.568 DKK
TRCL-4		G4 5.238 DKK
TRCL-5		G5 5.924 DKK
TRCC-1	padded	G1 (COM/COL) 3.898 DKK
TRCC-2		G2 4.204 DKK
TRCC-3		G3 4.890 DKK
TRCC-4		G4 5.560 DKK
TRCC-5		G5 6.280 DKK

End seat L150 smooth or padded upholstery

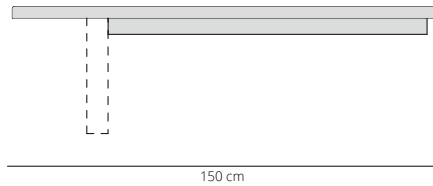

18.4 kg

(x1) 165x64x8cm (0.08m³)
(x1) 125x6x9cm (0.01m³)

CODE	FINISHES	PUBLIC PRICE
TREL-1	smooth	G1 (COM/COL) 4.314 DKK
TREL-2		G2 4.721 DKK
TREL-3		G3 5.509 DKK
TREL-4		G4 6.331 DKK
TREL-5		G5 7.170 DKK
TREC-1	padded	G1 (COM/COL) 4.610 DKK
TREC-2		G2 4.983 DKK
TREC-3		G3 5.763 DKK
TREC-4		G4 6.644 DKK
TREC-5		G5 7.424 DKK

SUGGESTIONS

The prices of the compositions shown below are valued for smooth upholstery.

Composition 1

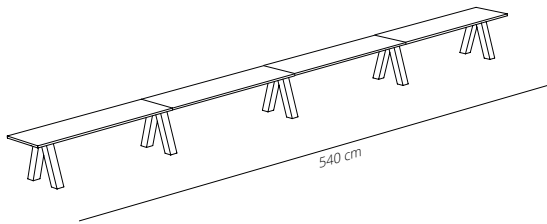

CODE	FINISHES	PUBLIC PRICE
COMPOSITION 1	G1 (COM/COL)	31.332 DKK
	G2	32.790 DKK
	G3	35.705 DKK
	G4	38.688 DKK
	G5	41.739 DKK

Components: 2 x TREL
2 x TRCL
5 x TRP

Composition 2

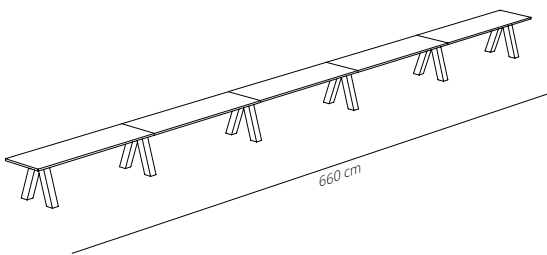

CODE	FINISHES	PUBLIC PRICE
COMPOSITION 2	G1 (COM/COL)	38.019 DKK
	G2	39.799 DKK
	G3	43.384 DKK
	G4	47.036 DKK
	G5	50.774 DKK

Components: 2 x TREL
3 x TRCL
6 x TRP

Composition 3

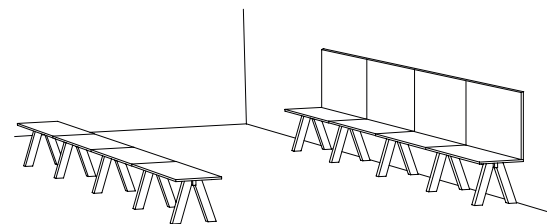

CODE	FINISHES	PUBLIC PRICE
COMPOSITION 3	G1 (COM/COL)	77.309 DKK
	G2	82.089 DKK
	G3	92.089 DKK
	G4	102.192 DKK
	G5	112.429 DKK

Components: 4 x TREL
4 x TRCL
10 x TRP
2 x TRRCL
2 x TRREL

Composition 4

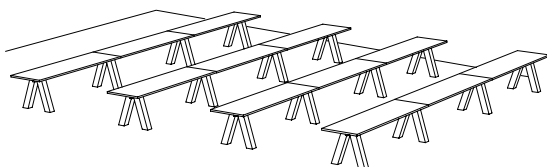

CODE	FINISHES	PUBLIC PRICE
COMPOSITION 4	G1 (COM/COL)	98.581 DKK
	G2	103.124 DKK
	G3	112.107 DKK
	G4	121.362 DKK
	G5	130.820 DKK

Components: 8 x TREL
4 x TRCL
16 x TRP



Common

BY NAOTO FUKASAWA

BENCHES

Test certificates: ANSI BIFMA X5.4-2012 (H40)

Common is a modular collection of benches that allows different settings to be created through a variety of compositions. To give you an example, some of the most common options are pictured below. The tolerance of the different elements can be +/- 3 cm.

- 1- Interior structure in solid wood and perforated top of microparticles low in formaldehyde. For the production of this pieces Viccarbe is using wood from certified sustainable forestry sources
- 2- Expanded polyurethane foam in different densities.
- 3- Polyester fibre covering.
- 4- Fabric.
- 5- Legs in matt varnished natural beech.

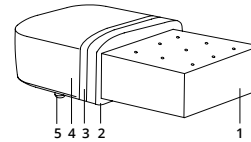

NOTE: Leather and some technical upholster models are manufactured with different seams.

**Felt glides available with an upcharge of 4€.*

If not indicated, the chair will be produced with plastic glides.

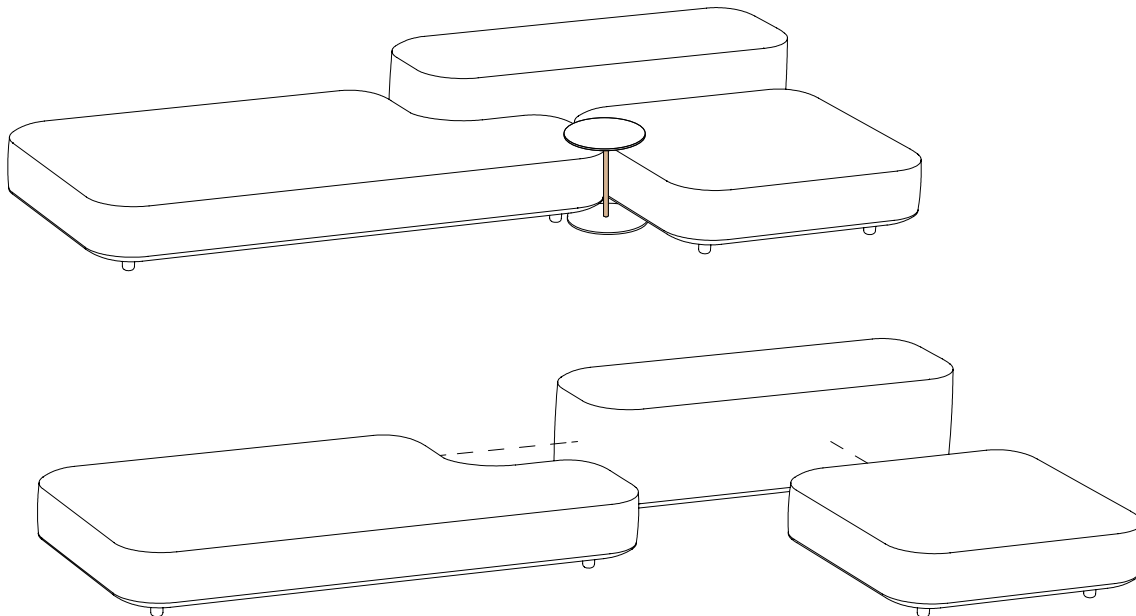

NOTE: The CO240F and CO180F benches can be used in two positions. Indicate the desired option in the order, remembering that left / right is understood by looking at the element straight from above for manufacturing purposes.



Right



Left

Needed fabric for material
1.40 m wide:
Bench 120L: 2.8 m
Bench 120H: 3.3 m
Bench 120HP: 3.3 m

Bench 120L

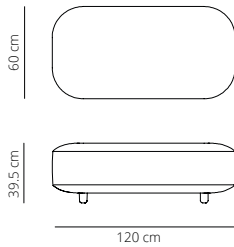

21.6 kg
(x1) 125x65x45cm (0.37 m³)

CODE	FINISHES	PUBLIC PRICE
CO120L-1	G1 (COM/COL)	10.331 DKK
CO120L-2	G2	10.899 DKK
CO120L-3	G3	12.145 DKK
CO120L-4	G4	13.958 DKK
CO120L-5	G5	15.721 DKK

Bench 120H

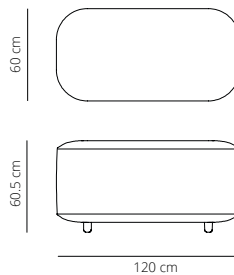

27.9 kg
(x1) 125x65x66cm (0.54 m³)

CODE	FINISHES	PUBLIC PRICE
CO120H-1	G1 (COM/COL)	10.746 DKK
CO120H-2	G2	11.365 DKK
CO120H-3	G3	12.662 DKK
CO120H-4	G4	14.577 DKK
CO120H-5	G5	16.450 DKK

Bench 120HP

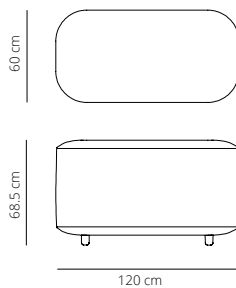

30.2 kg
(x1) 122x77x65 cm (0.61 m³)

CODE	FINISHES	PUBLIC PRICE
CO120HP-1	G1 (COM/COL)	11.416 DKK
CO120HP-2	G2	12.094 DKK
CO120HP-3	G3	13.450 DKK
CO120HP-4	G4	15.467 DKK
CO120HP-5	G5	17.433 DKK

Needed fabric for material
1.40 m wide:
Bench 120C: 4.0 m
Bench 180L: 4.0 m
Bench 180H: 4.5 m

BENCHES

Bench 120C

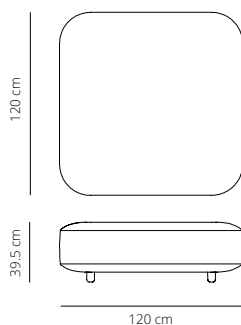

44.4 kg
(x1) 125x122x45 cm (0.69 m³)

CODE	FINISHES	PUBLIC PRICE
CO120C-1	G1 (COM/COL)	11.738 DKK
CO120C-2	G2	12.399 DKK
CO120C-3	G3	13.814 DKK
CO120C-4	G4	15.823 DKK
CO120C-5	G5	17.899 DKK

Bench 180L

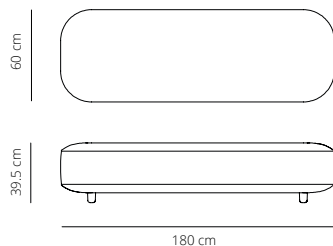

33.6 kg
(x1) 65x185x45cm (0.52 m³)

CODE	FINISHES	PUBLIC PRICE
CO180L-1	G1 (COM/COL)	12.458 DKK
CO180L-2	G2	13.128 DKK
CO180L-3	G3	14.577 DKK
CO180L-4	G4	16.772 DKK
CO180L-5	G5	19.001 DKK

Bench 180H

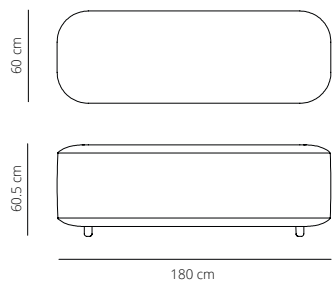

42 kg
(x1) 65x185x65cm (0.78 m³)

CODE	FINISHES	PUBLIC PRICE
CO180H-1	G1 (COM/COL)	12.865 DKK
CO180H-2	G2	13.645 DKK
CO180H-3	G3	15.102 DKK
CO180H-4	G4	17.433 DKK
CO180H-5	G5	19.670 DKK

Needed fabric for material
1.40 m wide:
Bench 180HP: 4.5 m
Bench 180R: 5.6 m
Bench 180F: 6.6 m

Bench 180HP

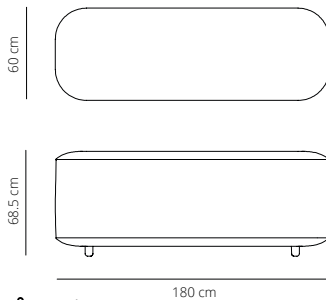

43.1 kg
(x1) 76x185x65cm (0.91 m³)

CODE	FINISHES	PUBLIC PRICE
CO180HP-1	G1 (COM/COL)	13.645 DKK
CO180HP-2	G2	14.433 DKK
CO180HP-3	G3	16.035 DKK
CO180HP-4	G4	18.425 DKK
CO180HP-5	G5	20.865 DKK

Bench 180R

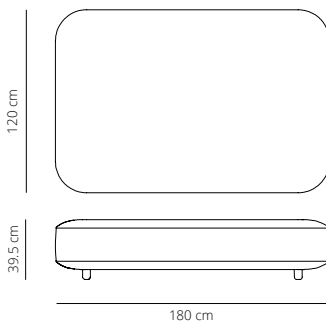

62.5 kg
(x1) 181x125x45cm (1.02 m³)

CODE	FINISHES	PUBLIC PRICE
CO180R-1	G1 (COM/COL)	16.603 DKK
CO180R-2	G2	17.594 DKK
CO180R-3	G3	19.560 DKK
CO180R-4	G4	22.527 DKK
CO180R-5	G5	25.433 DKK

Bench 180F

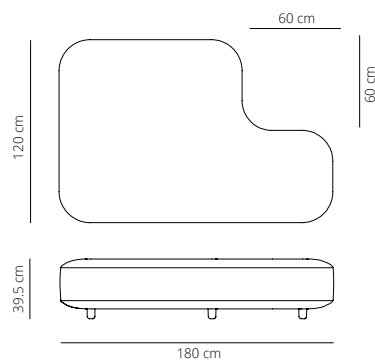

56.8 kg
(x1) 181x125x45cm (1.02m³)

CODE		FINISHES	PUBLIC PRICE
RIGHT	LEFT		
CO180FD-1	CO180FI-1	G1 (COM/COL)	17.340 DKK
CO180FD-2	CO180FI-2	G2	18.314 DKK
CO180FD-3	CO180FI-3	G3	20.348 DKK
CO180FD-4	CO180FI-4	G4	23.408 DKK
CO180FD-5	CO180FI-5	G5	26.467 DKK

BENCHES

Needed fabric for material
1.40 m wide:
Bench 240F: 7.0 m

Bench 240F

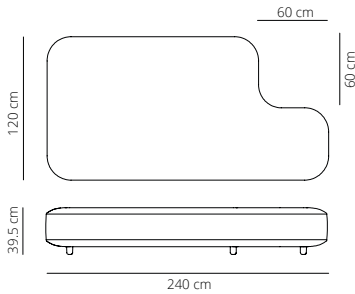

80 kg
(x1) 245x125x45cm (1.38 m³)

CODE		FINISHES	PUBLIC PRICE
RIGHT	LEFT		
CO240FD-1	CO240FI-1	G1 (COM/COL)	21.077 DKK
CO240FD-2	CO240FI-2	G2	22.323 DKK
CO240FD-3	CO240FI-3	G3	24.815 DKK
CO240FD-4	CO240FI-4	G4	28.493 DKK
CO240FD-5	CO240FI-5	G5	32.230 DKK

POWER OPTIONS

Built-in SCHUKO powerbox/ USB hub

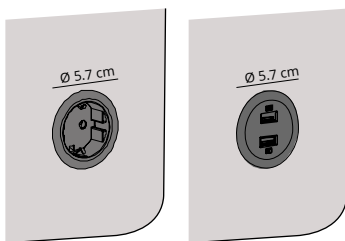

1 kg
Included and installed in the sofa

CODE	FINISHES	PUBLIC PRICE
COELE	black	831 DKK
COELUA		1.144 DKK

COELE: Built-in Schuko socket powerbox for device charging.
Dimensions: Ø 5.7 cm

COELUA: Built-in double USB hub for device charging.
Dimensions: Ø 5.7 cm

The powerbox has a Wieland connector. The power connection cable is not included, and will have to be provided by the customer.

Built-in powerbox

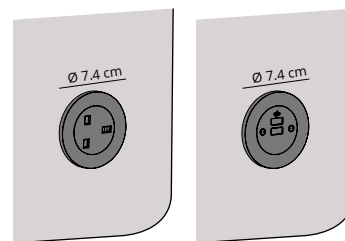

1 kg
Included and installed in the sofa

CODE	FINISHES	PUBLIC PRICE
COELO	black	1.144 DKK
COELUC		2.390 DKK

COELO*: Built-in powerbox with multiple country socket connections available.
Dimensions: Ø 7.4 cm

COELUC: Built-in double USB-A + USB-C hub for device charging.
Dimensions: Ø 7.4 cm

The powerbox has a Wieland connector. The power connection cable is not included, and will have to be provided by the customer.

*For all available power options see page 506.

POWER POSITION OPTIONS

Bench 120L

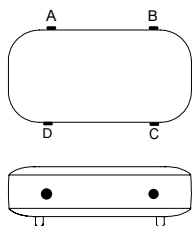

Bench 120H

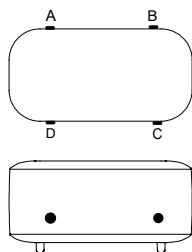

Bench 120HP

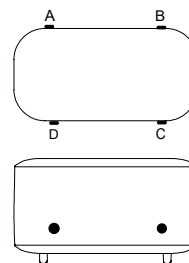

Bench 120C

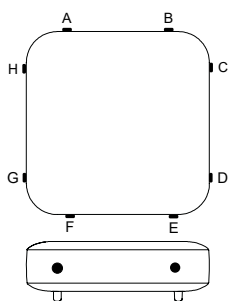

Bench 180L

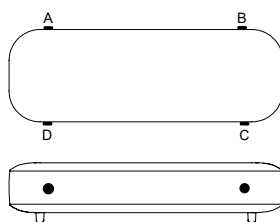

Bench 180H

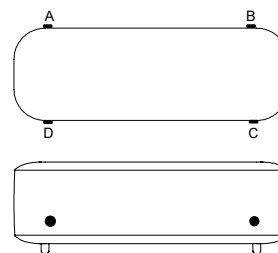

Bench 180HP

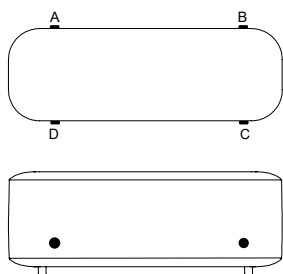

Bench 180R

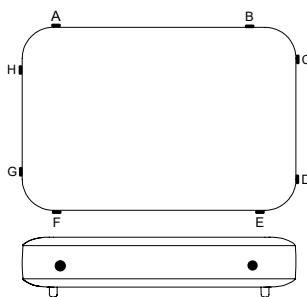

Bench 180F

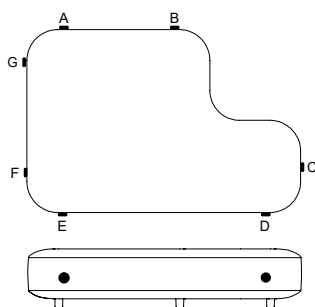

Bench 240F

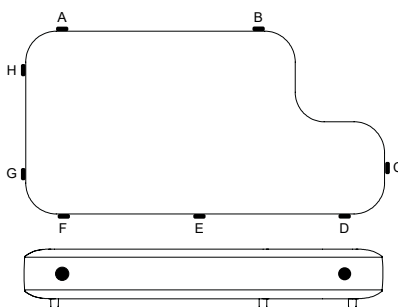

NOTE 1: A, B, C, D, E, F, G and H are references of connection points where the electrification articles can be located, in which up to 1 article can be placed per connection point. Plug and USB options can be combined within the same piece of furniture.

NOTE: As the power devices are installed inside the upholstery, a tolerance of 3cm respect the dimensions provided may be expected.

BENCHES

Test certificates: ANSI/SOHO S6.5 R2013 and UNE-EN 15372:2017

SIDE TABLES

- 1- Base and top in MDF.
- 2- Calibrated steel column, powder coated in thermoreinforced polyester, finished in beech veneer, stained with matt varnish or upholstered with leather or ecoleather.

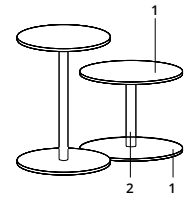

NOTE: There is the possibility of combine boards of different colors. In that case, always consider the price of the upper category.

Table 45

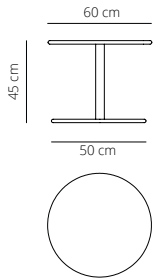

13,3 kg
 (x1) 75x70x49cm (0.25 m³)

CODE	FINISHES		PUBLIC PRICE
	COLUMN	TOP	
COD60H45	matt beech	white or black	4.110 DKK
		taupe, brick, ocre, olive green, dusty pink and dusty green	4.356 DKK
		bronze	4.534 DKK

Table 65

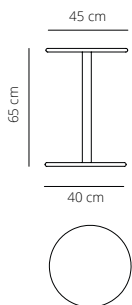

14,5 kg
 (x1) 58x56x71cm (0.23 m³)

CODE	FINISHES		PUBLIC PRICE
	COLUMN	TOP	
COD45H65	matt beech	white or black	4.110 DKK
		taupe, brick, ocre, olive green, dusty pink and dusty green	4.356 DKK
		bronze	4.534 DKK

**The whole range of colours has a smooth lacquered finish except black, which has a lacquered microtextured finish.*

Table 45 with upholstered column

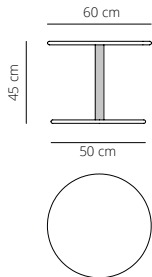

👤 13,3 kg

📦 (x1) 75x70x49cm (0.25 m³)

CODE	FINISHES		PUBLIC PRICE
	COLUMN	TOP	
COD60H45-2	ecoleather	white or black	5.500 DKK
		taupe, brick, ocre, olive green, dusty pink and dusty green	5.729 DKK
		bronze	5.916 DKK
COD60H45-5	leather	white or black	5.500 DKK
		taupe, brick, ocre, olive green, dusty pink and dusty green	5.729 DKK
		bronze	5.916 DKK

Table 65 with upholstered column

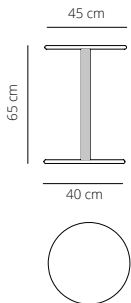

👤 14,5 kg

📦 (x1) 58x56x71cm (0.23 m³)

CODE	FINISHES		PUBLIC PRICE
	COLUMN	TOP	
COD45H65-2	ecoleather	white or black	5.500 DKK
		taupe, brick, ocre, olive green, dusty pink and dusty green	5.729 DKK
		bronze	5.916 DKK
COD45H65-5	leather	white or black	5.500 DKK
		taupe, brick, ocre, olive green, dusty pink and dusty green	5.729 DKK
		bronze	5.916 DKK

SUGGESTIONS

All the compositions featuring tables shown below are priced in colour group 1 (white or black).

Composition 1

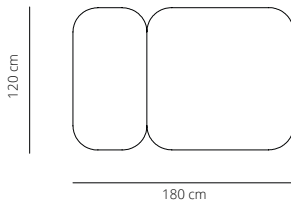

CODE	FINISHES	PUBLIC PRICE
COMPOSITION 1	G1 (COM/COL)	22.484 DKK
	G2	23.764 DKK
	G3	26.476 DKK
	G4	30.400 DKK
	G5	34.349 DKK

Components: 1 x CO120C
1 x CO120H

Composition 2

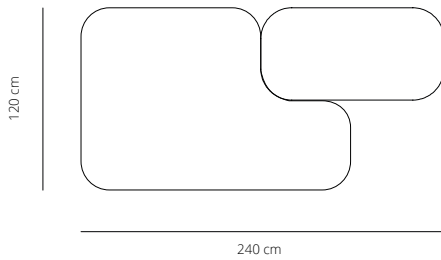

CODE	FINISHES	PUBLIC PRICE
COMPOSITION 2	G1 (COM/COL)	28.086 DKK
	G2	29.679 DKK
	G3	33.010 DKK
	G4	37.985 DKK
	G5	42.917 DKK

Components: 1 x CO180F
1 x CO120H

Composition 3

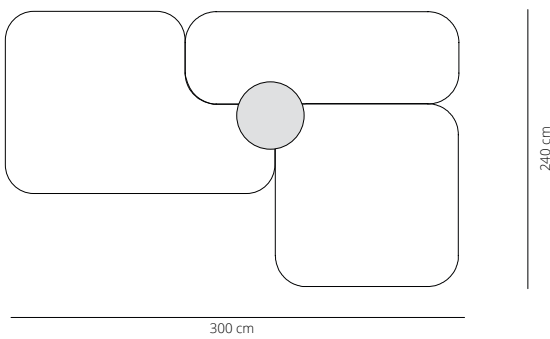

CODE	FINISHES	PUBLIC PRICE
COMPOSITION 3	G1 (COM/COL)	46.053 DKK
	G2	48.469 DKK
	G3	53.376 DKK
	G4	60.774 DKK
	G5	68.147 DKK

Components: 1 x CO180H
1 x CO180F
1 x CO120C
1 x COD45H65

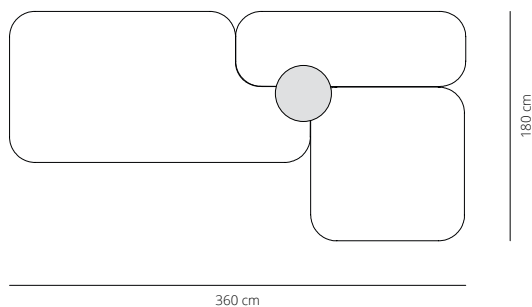
Composition 4

CODE	FINISHES	PUBLIC PRICE
COMPOSITION 4	G1 (COM/COL)	49.791 DKK
	G2	52.477 DKK
	G3	57.842 DKK
	G4	65.859 DKK
	G5	73.910 DKK

Components: 1 x CO240F
 1 x CO120C
 1 x CO180H
 1 x COD45H65

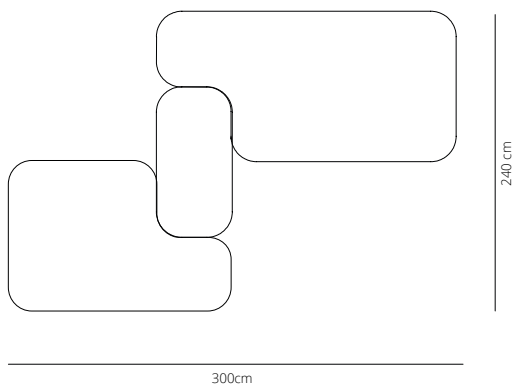
Composition 5

CODE	FINISHES	PUBLIC PRICE
COMPOSITION 5	G1 (COM/COL)	49.163 DKK
	G2	52.003 DKK
	G3	57.825 DKK
	G4	66.478 DKK
	G5	75.148 DKK

Components: 1 x CO240F
 1 x CO180F
 1 x CO120H

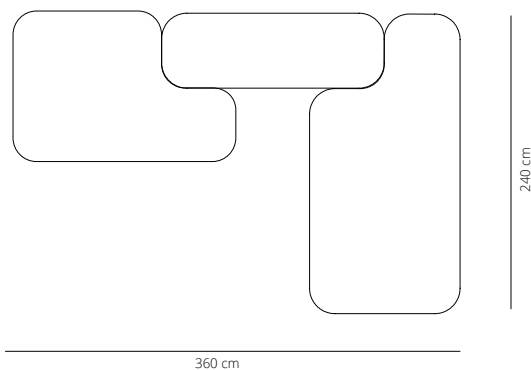
Composition 6

CODE	FINISHES	PUBLIC PRICE
COMPOSITION 6	G1 (COM/COL)	51.282 DKK
	G2	54.282 DKK
	G3	60.266 DKK
	G4	69.334 DKK
	G5	78.368 DKK

Components: 1 x CO240F
 1 x CO180F
 1 x CO180H



Season Pouf

BY PIERO LISSONI

BENCHES

Piero Lissoni's successful collection grows with poufs of new dimensions, maintaining the option of incorporating his intelligent system of hidden casters - very suitable for office and educational spaces where agility and dynamism are paramount - as well as his particular strap, making it easier to move around places.

Test certificates: ANSI/BIFMA X5.4:2020 and UNE-EN 16139:2013vc2015 (for all sizes, only fixed models)

- 1- Interior structure in solid wood and perforated top of micro particles low in formaldehyde. For the production of this piece Viccarbe is using wood from certified sustainable forestry sources.
- 2- Expanded polyurethane foam in different densities.
- 3- Fabric or leather.
- 4- Strap or belt produced in high-resistance technical fabric black, grey and red.
- 5- Hidden casters or height adjustment legs.

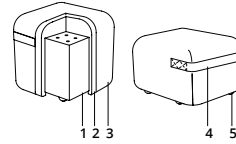

Needed fabric for material 1.40 m wide:
Season Pouf 40: 1.45 m

Pouf 40 fixed or with casters

With strap

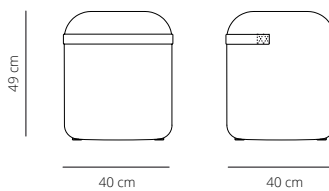

📦 10.2 kg

📦 (x1) 45x45x53 cm (0.11 m³)

Without strap

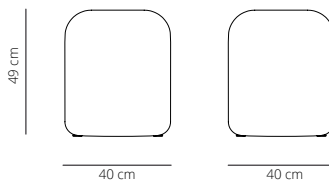

📦 10.2 kg

📦 (x1) 45x45x53 cm (0.11 m³)

CODE	FINISHES			PUBLIC PRICE	
	STRAP	BASE	UPHOLSTERY		
SEM40-1	without strap	black, grey or red	G1 (COM/COL)	3.170 DKK	
SEM40-2			G2	3.534 DKK	
SEM40-3			without casters	G3	4.102 DKK
SEM40-4			G4	4.721 DKK	
SEM40-5			G5	5.297 DKK	
SEMR40-1			with casters	G1 (COM/COL)	3.365 DKK
SEMR40-2			G2	3.737 DKK	
SEMR40-3			G3	4.314 DKK	
SEMR40-4			G4	4.932 DKK	
SEMR40-5			G5	5.509 DKK	

Test certificates: ANSI/BIFMA X5.4:2020 and UNE-EN 16139:2013vc2015 (for all sizes, only fixed models)

1- Interior structure in solid wood and perforated top of microparticles low in formaldehyde. For the production of this pieces Viccarbe is using wood from certified sustainable forestry sources.

2- Expanded polyurethane foam in different densities.

3- Fabric or leather.

4- Strap or belt produced in high-resistance technical fabric black, grey and red.

5- Hidden casters or height adjustment legs.

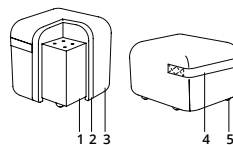

Needed fabric for material 1.40 m wide:

Season Pouf 50: 1.70 m

Pouf 50 fixed or with casters

With strap

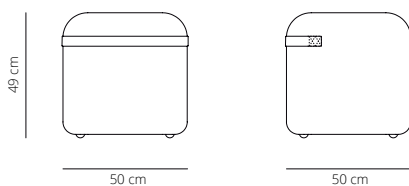

▲ 11.9 kg

📦 (x1) 53x53x53cm (0.15 m³)

Without strap

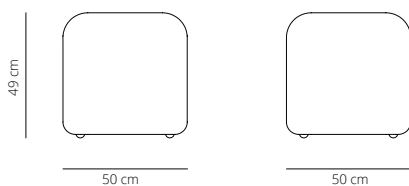

▲ 11.9 kg

📦 (x1) 53x53x53cm (0.15 m³)

CODE	FINISHES			PUBLIC PRICE	
	STRAP	BASE	UPHOLSTERY		
SEM50-1	without strap	black, grey or red	without casters	G1 (COM/COL)	3.898 DKK
SEM50-2				G2	4.356 DKK
SEM50-3				G3	4.932 DKK
SEM50-4				G4	5.509 DKK
SEM50-5				G5	6.136 DKK
SEMR50-1			with casters	G1 (COM/COL)	4.102 DKK
SEMR50-2				G2	4.610 DKK
SEMR50-3				G3	5.144 DKK
SEMR50-4				G4	5.712 DKK
SEMR50-5				G5	6.390 DKK

BENCHES

Test certificates: ANSI/BIFMA X5.4:2020 and UNE-EN 16139:2013vc2015 (for all sizes, only fixed models)

- 1- Interior structure in solid wood and perforated top of microparticles low in formaldehyde. For the production of this pieces Viccarbe is using wood from certified sustainable forestry sources
- 2- Expanded polyurethane foam in different densities.
- 3- Fabric or leather.
- 4- Strap or belt produced in high-resistance technical fabric black, grey and red.
- 5- Hidden casters or height adjustment legs.

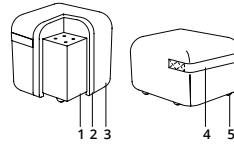

Needed fabric for material 1.40 m wide:
Season Pouf 60: 1.60 m

Pouf 60 fixed or with casters

With strap

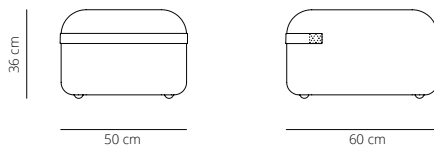

11.4 kg
 (x1) 63x54x40cm (0.14 m³)

Without strap

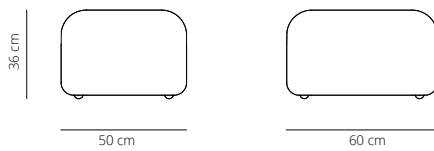

11.4 kg
 (x1) 63x54x40cm (0.14 m³)

CODE	FINISHES			PUBLIC PRICE
	STRAP	BASE	UPHOLSTERY	
SEM60-1	without strap	black, grey or red	G1 (COM/COL)	3.898 DKK
SEM60-2			G2	4.356 DKK
SEM60-3			G3	4.932 DKK
SEM60-4			G4	5.509 DKK
SEM60-5			G5	6.136 DKK
SEMR60-1		with casters	G1 (COM/COL)	4.102 DKK
SEMR60-2			G2	4.610 DKK
SEMR60-3			G3	5.144 DKK
SEMR60-4			G4	5.712 DKK
SEMR60-5			G5	6.390 DKK

Test certificates: ANSI/BIFMA X5.4:2020 and UNE-EN 16139:2013vc2015 (for all sizes, only fixed models)

- 1- Exterior structure in solid wood and perforated top of micro particles low in formaldehyde. For the production of this piece Viccarbe is using wood from certified sustainable forestry sources.
- 2- Expanded polyurethane foam in different densities.
- 3- Fabric or leather.
- 4- Hidden casters or height adjustment legs.

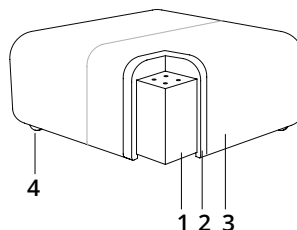

Needed fabric for material
1.40 m wide:
Season Pouf 90 H36: 3.45 m
Season Pouf 90 H49: 3.8 m

HEIGHT 36

Pouf 90 fixed or with casters

Without strap

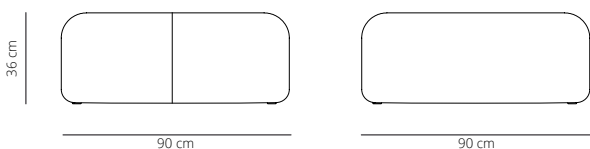

 26.5 kg

 (x1) 95x95x43 cm (0.39 m³)

CODE	FINISHES		PUBLIC PRICE
	BASE	UPHOLSTERY	
SEM90-1	without casters	G1 (COM/COL)	5.144 DKK
SEM90-2		G2	6.026 DKK
SEM90-3		G3	7.111 DKK
SEM90-4		G4	7.890 DKK
SEM90-5		G5	8.305 DKK
SEMR90-1	with casters	G1 (COM/COL)	5.348 DKK
SEMR90-2		G2	6.280 DKK
SEMR90-3		G3	7.314 DKK
SEMR90-4		G4	8.144 DKK
SEMR90-5		G5	8.509 DKK

HEIGHT 49

Pouf 90 fixed or with casters

Without strap

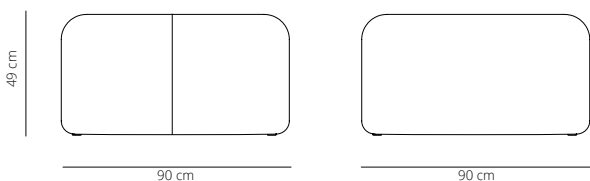

 30.3 kg

 (x1) 95x95x53 cm (0.48 m³)

CODE	FINISHES		PUBLIC PRICE
	BASE	UPHOLSTERY	
SEM90H-1	without casters	G1 (COM/COL)	5.348 DKK
SEM90H-2		G2	6.280 DKK
SEM90H-3		G3	7.314 DKK
SEM90H-4		G4	8.144 DKK
SEM90H-5		G5	8.509 DKK
SEMR90H-1	with casters	G1 (COM/COL)	5.560 DKK
SEMR90H-2		G2	6.483 DKK
SEMR90H-3		G3	7.526 DKK
SEMR90H-4		G4	8.416 DKK
SEMR90H-5		G5	8.619 DKK

POWER OPTIONS

Built-in SCHUKO/USB powerbox

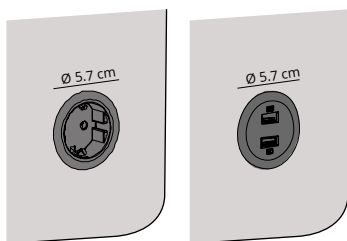

1 kg
Included and installed in the sofa

CODE	FINISHES	PUBLIC PRICE
SEMELE	black	831 DKK
SEMELUA		1.144 DKK

SEMELE: Built-in Schuko socket powerbox for device charging. Dimensions: Ø 5.7 cm

SEMELUA: Built-in double USB hub for device charging. Dimensions: Ø 5.7 cm

NOTE: Only available for SEM90, SEMR90, SEM90H and SEMR90H models.

The powerbox has a Wieland connector. The power connection cable is not included, and will have to be provided by the customer.

Built-in powerbox

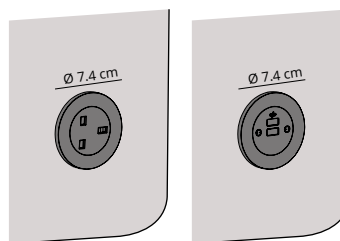

1 kg
Included and installed in the sofa

CODE	FINISHES	PUBLIC PRICE
SEMELO	black	1.144 DKK
SEMELUC		2.390 DKK

SEMELO*: Built-in powerbox with multiple country socket connections available. Dimensions: Ø 7.4 cm

SEMELUC: Built-in double USB-A + USB-C hub for device charging. Dimensions: Ø 7.4 cm

NOTE: Only available for SEM90, SEMR90, SEM90H and SEMR90H models.

The powerbox has a Wieland connector. The power connection cable is not included, and will have to be provided by the customer.
*For all available power options [see page 506](#).

POWER POSITION OPTIONS

Pouf 90 - Height 49

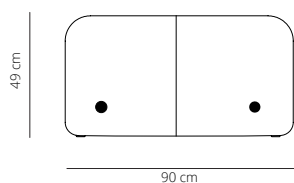
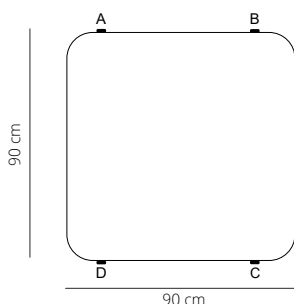

Pouf 90 - Height 36

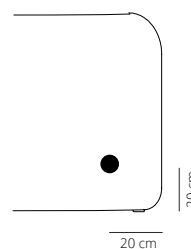
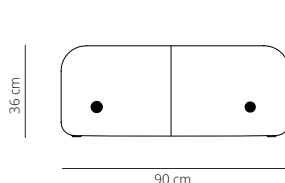
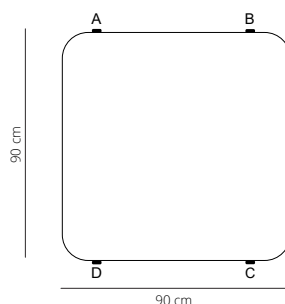

NOTE 1: A, B, C and D are references of connection points where the electrification articles can be located, in which up to 1 article can be placed per connection point. Plug and USB options can be combined within the same piece of furniture.

NOTE 2: As the power devices are installed inside the upholstery, a tolerance of 3cm respect the dimensions provided may be expected.



Trivio ^{NEW}

BY JASPER MORRISON

TABLES

Bistro style table made for single 80 cm tabletop, three solid wood legs and a connecting piece that joins all the elements together for an easy assembly.

The table top is made of 30 mm thick MDF with a stained, lacquered or HPL finish. The legs are made of solid European oak, stained in the finishes of the collection. The join piece is made of steel, powder coated in thermoreinforced polyester in the finishes of the collection.

Table thickness and edge type:

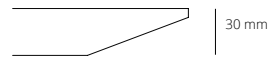

Available from 2 May 2023

TABLE 80Ø

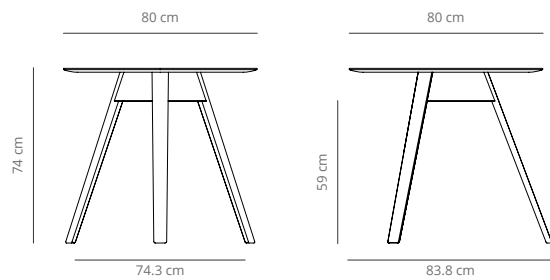

22 kg
(x1) 92.5x92.5x21.5cm (0.18m³)

CODE		FINISHES			PUBLIC PRICE	
		CONNECTOR	LEGS	TABLETOP		
VCBTRI80RO	TRI80RO	black, white, taupe or fluorescent orange	stained oak: matt oak, cognac, ash, bleached oak or walnut	stained oak	matt oak, cognac, ash, bleached oak or walnut	6.738 DKK
-	TRI80TX			lacquered	black, white, taupe, brick, ochre, olive green, dusty pink, dusty green or bronze	6.712 DKK
-	TRI80HPLB			HPL with MDF	white	8.382 DKK
-	TRI80HPLN			HPL Soft Touch by Fenix with MDF	black	8.382 DKK

+ 4€



*Felt glides available with an upcharge of 4€. If not indicated, the chair will be produced with plastic glides.

ACCESORIES

Wire holder

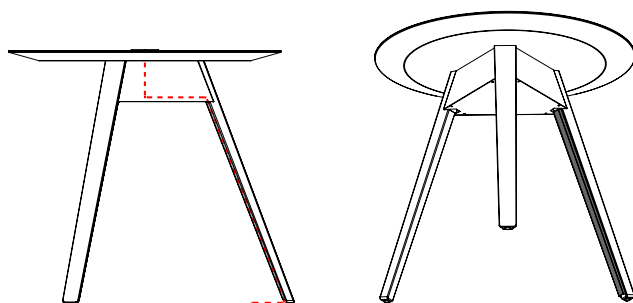

1.2 kg
Included and installed in the package

CODE		FINISHES	PUBLIC PRICE
-	TRICAN	black or white	169 DKK

Wire holder made of steel sheet, powder coated in thermoreinforced polyester. Mounting on the leg by manual adjustment without the need for tools. The fastening screws are included and installed.

POWER OPTIONS

Center of the table built-in SCHUKO/USB powerbox



1 kg
Included and installed in the table

CODE		FINISHES	PUBLIC PRICE
-	TRIELE	black	831 DKK
-	TRIELUA		1.144 DKK

TRIELE: Built-in Schuko socket powerbox in the middle of the table for device charging
Dimensions: Ø 5.7 cm

TRIELUA: Built-in double USB hub in the middle of the table for device charging
Dimensions: Ø 5.7 cm

The powerbox has a Wieland connector. The power connection cable is not included, and will have to be provided by the customer.

Center of the table built-in powerbox

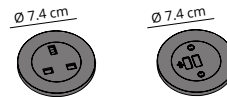

1 kg
Included and installed in the table

CODE		FINISHES	PUBLIC PRICE
-	TRIELO	black	1.144 DKK
-	TRIELUC		2.390 DKK

TRIELO*: Built-in powerbox in the center of the table with multiple country socket connections available*
Dimensions: Ø 7.4 cm

TRIELUC: Built-in double USB-A + USB-C hub in the middle of the table for device charging.
Dimensions: Ø 7.4 cm

The powerbox has a Wieland connector. The power connection cable is not included, and will have to be provided by the customer.
*For all available power options see page 505.

Center of the table USB hub

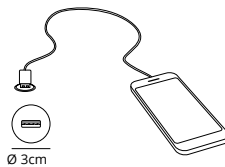

Included and installed in the table

CODE	FINISHES	PUBLIC PRICE
-	TRIUUSB	black or white 525 DKK

Built-in USB hub for charging electronic devices, built in the center of the tabletop. The cable length is 1.0 m with USB connection. Available in black or white.

Dimensions: Ø 3 cm

USB hub with battery

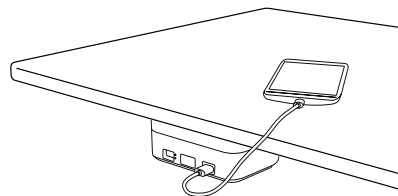

1.4 kg
(x1) 40x20x25cm (0.02 m3)

CODE	FINISHES	PUBLIC PRICE
VCBTRIELB	TRIEL-B	black 2.187 DKK

USB hub with two USB device charging ports without being plugged into electric current. It's needed to buy the battery charging tray to charge the USB hub battery.

Battery charging tray

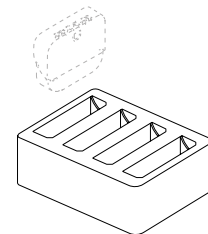

1 kg
(x1) 40x20x25cm (0.02 m3)

CODE	FINISHES	PUBLIC PRICE
VCBTRIELC	TRIEL-C	black 2.542 DKK

Battery charging tray. Charges up to four stations simultaneously in 7 hours. Includes magnetic key to remove the station from its support.



Foro ^{NEW}

BY JOHN PAWSON

TABLES

Forum is our new venture with designer John Pawson. A collection of minimalist tables meticulously crafted in oak, the noblest material for conveying richness, warmth and depth to any environment. Forum can include a patented electrification mechanism that cleverly conceals the cables through the leg. A practical complement to connect equipment and boost productivity.

Made of wood, the legs of the Foro table are made of solid polished American oak, joined by a polished ash wood frame like the legs. The tabletop is made from European oak and polished to match the legs in the finishes of the collection.

TABLE 140x140

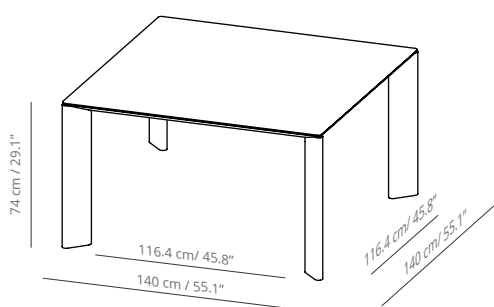

- (x1) 44.6kg
(x1) 21kg
- (x1) 160x160x13.5cm (0.35m³)
(x1) 79x58x29cm (0.13m³)

FINISHES				PUBLIC PRICE
CODE		TOP AND LEGS		
-	FO140RO	stained	matt oak, cognac, ash, bleached oak or walnut	22.120 DKK

Suggested maximum number of seats per table, calculated with an Aleta chair. The number of seats may vary depending on the chair model.

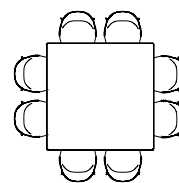
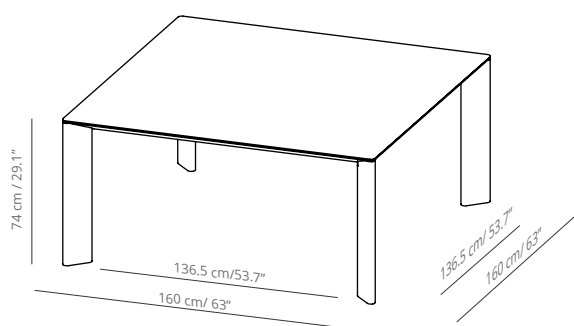

TABLE 160x160



- (x1) 54kg
(x1) 21kg
- (x1) 180x180x13.5cm (0.44m³)
(x1) 79x58x29cm (0.13m³)

FINISHES				PUBLIC PRICE
CODE		TOP AND LEGS		
-	FO160RO	stained	matt oak, cognac, ash, bleached oak or walnut	25.255 DKK

Suggested maximum number of seats per table, calculated with an Aleta chair. The number of seats may vary depending on the chair model.

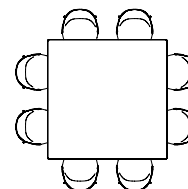
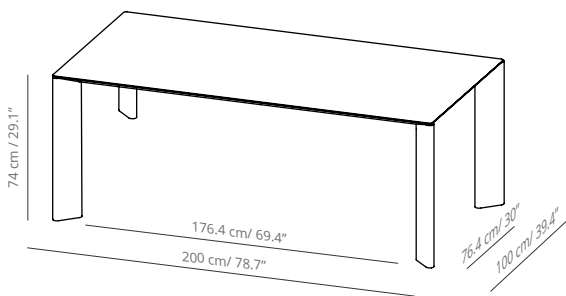

Table 200x100



- 📦 (x1) 46.5kg
(x1) 21kg
- 📦 (x1) 220x116.5x13.5cm (0.35m³)
(x1) 79x58x29cm (0.13m³)

FINISHES				PUBLIC PRICE
CODE	TOP AND LEGS			
-	FO200RO	stained	matt oak, cognac, ash, bleached oak or walnut	22.713 DKK

Suggested maximum number of seats per table, calculated with an Aleta chair. The number of seats may vary depending on the chair model.

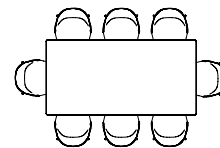
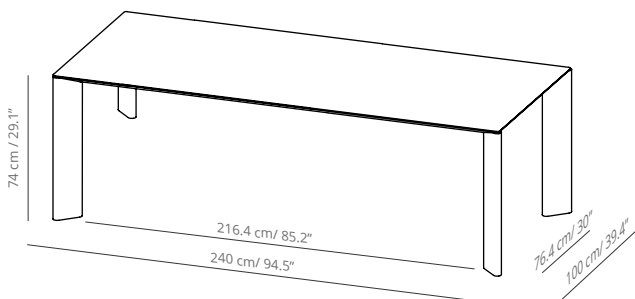

Table 240x100



- 📦 (x1) 54.1kg
(x1) 21kg
- 📦 (x1) 260x116.5x13.5cm (0.41m³)
(x1) 79x58x29cm (0.13m³)

FINISHES				PUBLIC PRICE
CODE	TOP AND LEGS			
-	FO240RO	stained	matt oak, cognac, ash, bleached oak or walnut	25.086 DKK

Suggested maximum number of seats per table, calculated with an Aleta chair. The number of seats may vary depending on the chair model.

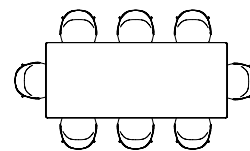

TABLES

Table 200x120

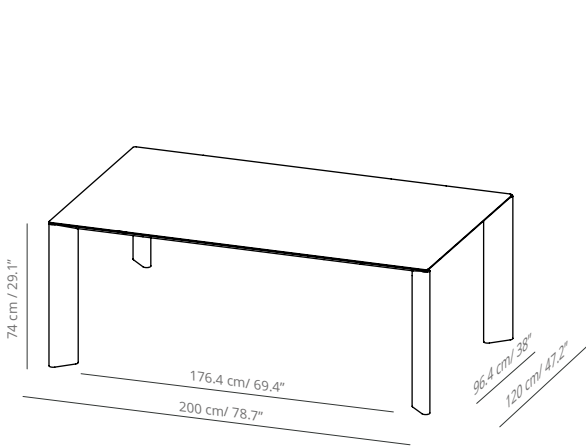

- 👤 (x1) 52.6kg
(x1) 21kg
- 📦 (x1) 220x136.5x13.5cm (0.41m³)
(x1) 79x58x29cm (0.13m³)

FINISHES				PUBLIC PRICE
CODE	TOP AND LEGS			
-	FO200ARO	stained	matt oak, cognac, ash, bleached oak or walnut	24.493 DKK

Suggested maximum number of seats per table, calculated with an Aleta chair. The number of seats may vary depending on the chair model.

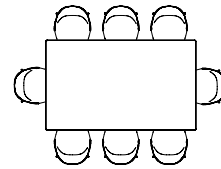
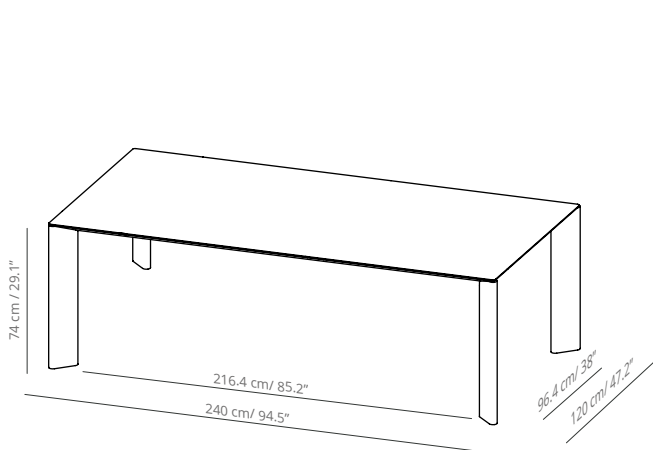

Table 240x120



- 👤 (x1) 124.1kg
(x1) 21kg
- 📦 (x1) 263x142x13.5cm (0.63m³)
(x1) 79x58x29cm (0.13m³)

FINISHES				PUBLIC PRICE
CODE	TOP AND LEGS			
-	FO240ARO	stained	matt oak, cognac, ash, bleached oak or walnut	27.035 DKK

Suggested maximum number of seats per table, calculated with an Aleta chair. The number of seats may vary depending on the chair model.

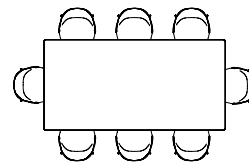

ACCESSORIES

Wire management leg

CODE		PUBLIC PRICE
-	FOPR	1.653 DKK

Management leg with a registered system to conduct wires from the top of the table to the floor completely hidden. Made of solid american oak, stained in the same finish as the table. The code of the leg must be noted in the order (FOPR)

 Included on the package

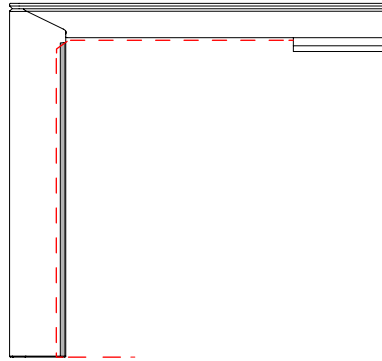

Utility model
registration pending

Cut out

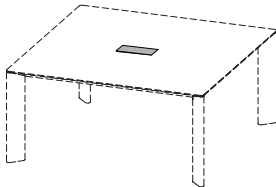



CODE		PUBLIC PRICE
-	FOMEK	1.093 DKK

Table top custom cut out. Price cut out table.

Table top hatch





 1.2 kg
 (x1) 34x18x9cm (0.006 m³)

CODE	FINISHES	PUBLIC PRICE
-	CAP black, white or grey	1.246 DKK

Metallic hatch access to the lower part of the table.
Available in white, black or grey.
Does not include power options.
Dimensions: 32x15 cm
** Cut out not included.*

Table top hatch plus





 1.2 kg
 (x1) 34x18x9cm (0.006 m³)

CODE	FINISHES	PUBLIC PRICE
-	CAPP black or grey	1.500 DKK

Metallic hatch access to the lower part of the table for wooden table tops. Metal frame available in black or grey and central part in the veneer of the finish of the table. Does not include power options.
Dimensions: 32x15 cm
** Cut out not included.*

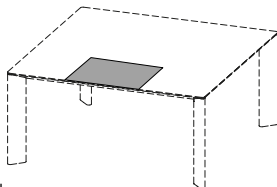
Table top protector in ecoleather





 1 kg
 Installed and included in the table top box

CODE		PUBLIC PRICE
-	FOPROT	2.187 DKK

Dimensions: 44x90 cm

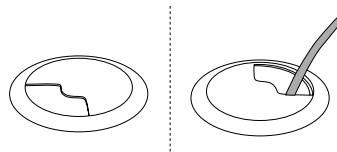
Wire hole



 Installed and included in the table top box

CODE	FINISHES	PUBLIC PRICE
-	AC03B black or white	153 DKK

Cut out of the board is included
Dimensions: Ø 6 cm



POWER OPTIONS

Hidden hatch set

CODE		FINISHES		PUBLIC PRICE
		HATCH	WIRE HOLDER	
-	FOCTO	top's stain	black	1.907 DKK

Built-in wooden hatch, that includes cut out and wire holder, with the same material and finish as the table top. Can be opened from both sides. Includes wire management devices.

Dimensiones: 29,5x14,8 cm

-  2.7 kg
-  (x1) 40x33x11cm (0.014 m³)

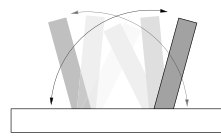
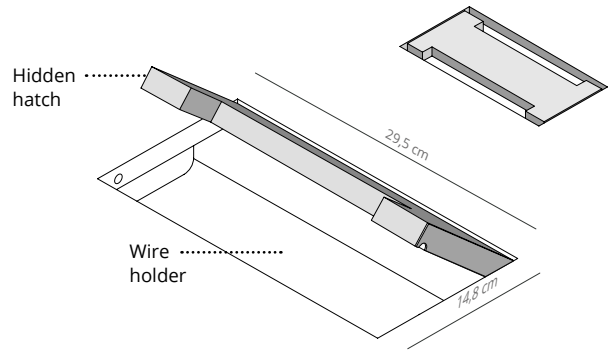

The hidden hatch can be opened from both sides

Hidden powerbox set



CODE		FINISHES		PUBLIC PRICE
		HATCH	POWERBOX AND WIRE HOLDER	
-	FOCPO-E	top's stain	black	3.220 DKK
-	FOCPO-M			4.000 DKK

Hidden powerbox set that includes cut out, table top hatch, powerbox, and wire holder. The finish of the hatch is the same as the table. Includes wire management devices. The powerbox may include:

- FOPOC-E:** 4 sockets
- FOPOC-M:** 4 devices (sockets and multimedia)

Dimensions: 29,5x14,8 cm

For all available power options *see page 505*.

-  3.7 kg
-  (x1) 40x33x11cm (0.014 m³)

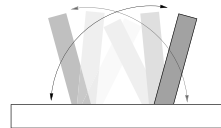
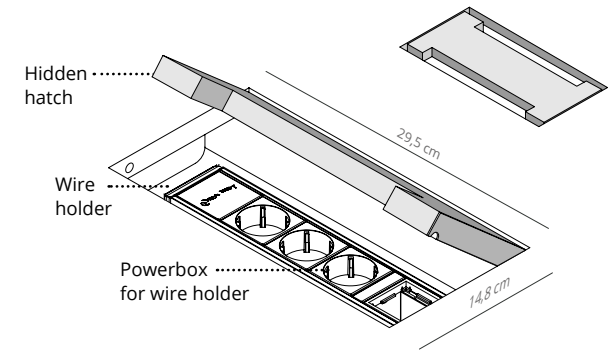

The hidden hatch can be opened from both sides

The powerbox has 4 modules (sockets or multimedia devices) to install power options. The modules can be complete (1) or half module. (1/2). The power options are under the UNE-EN 50085 standards.

The cable length is 0.3 meters with Wieland connector. The power connection cable is not included, and will have to be provided by the customer.

Double powerbox set

CODE		FINISHES		PUBLIC PRICE
		HATCH	POWERBOX AND WIRE HOLDER	
-	FOPOD-E	top's stain	black	4.534 DKK
-	FOPOD-M			6.094 DKK

Hidden powerbox set that includes cut out, table top hatch, powerbox, and wire holder. The finish of the hatch is the same as the table. Includes wire management devices.

The powerboxes may include:

FOPOD-E: 8 sockets

FOPOD-M: 8 devices (sockets and multimedia)

Dimensions: 32x15 cm

For all available power options *see page 505*.

 4.7 kg

 (x1) 40x33x11 cm (0.014 m³)

Each powerbox has 4 modules (sockets or multimedia) to accommodate electrification. The modules can be complete (1) or half (1/2). The electrification elements comply with the UNE-EN 50085 standard. The cable length is 0.3 metres with Wieland quick connector. The power connection cable is not included, and will have to be provided by the customer.

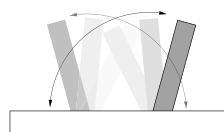
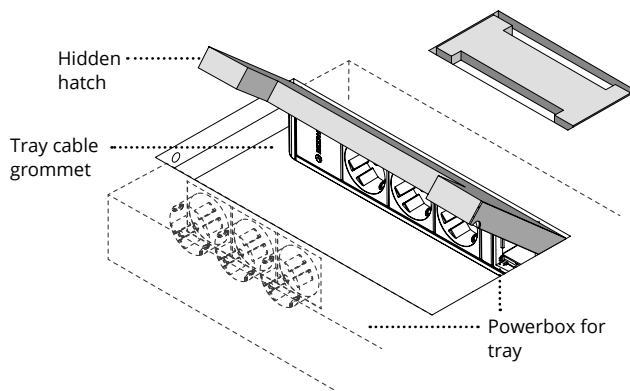

The hidden hatch is accessible and can be opened from both sides.

Table top hatch powerbox



 1.8 kg

 (x1) 33x17x8 cm (0.005 m³)

CODE	FINISHES	PUBLIC PRICE	
-	FOBOX-E	black, white or grey	2.441 DKK
-	FOBOX-M	3.534 DKK	

BOX-E: 4 sockets

BOX-M: 4 devices (sockets and multimedia)

Metallic hatch with 4 sockets or combined with built-in multimedia devices.

Available in white, black or grey

Dimensions: 32x15 cm

Cut out not included.

For all available power options *see page 505*.

Each hatch has 4 modules (sockets or multimedia devices) to install power options. The modules can be complete (1) or half module. (1/2). The power options are under the UNE-EN 50085 standards.

Table top hatch powerbox plus



 1.8 kg

 (x1) 33x17x8 cm (0.005 m³)

CODE	FINISHES	PUBLIC PRICE	
-	FOBOXP-E	black or grey	3.534 DKK
-	FOBOXP-M	4.610 DKK	

BOXP-E: 4 sockets

BOXP-M: 4 devices (sockets and multimedia)

Metallic hatch with 4 sockets or combined with built-in multimedia devices.

Available in white, black or grey

Dimensions: 32x15 cm

Cut out not included.

For all available power options *see page 505*.

For the references BOX-E, BOX-M, BOXP-E, BOXP-M, FOPOC-E, FOPOC-M, FOBOX-E and FOBOX-M, the cable length is 0.3 meters with Wieland connector. The power connection cable is not included, and will have to be provided by the customer.

POWER OPTIONS PLACEMENT SUGGESTIONS

We have curated a selection of cut out positions from the most demanded due to its polyvalence and flexibility. Please contact our sales team in case you need a quote for specials, we are open to listen to your needs. For other options, please contact the sales department, indicating the cut out reference in the order.

All the cut outs presented have the measure of a standard power box (32x15cm), compatible with the references CAP, CAPP, BOX-E, BOX-M, BOXP-E, BOXP-M, FOCPO-E, FOCPO-M and FOCTO. All cut out options are valid for both 100 cm and 120 cm wide tables.

200 TABLES

200 A

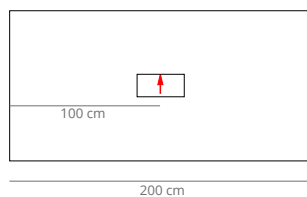

200 B

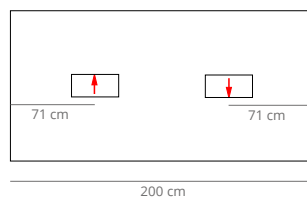

200 C

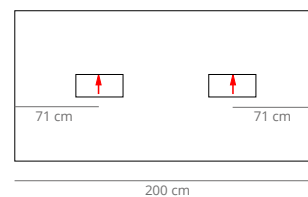

240 TABLES

240 A

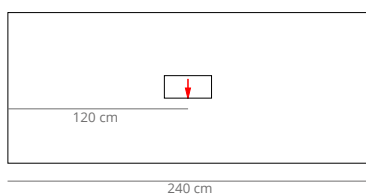

240 B

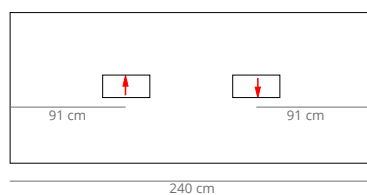

240 C

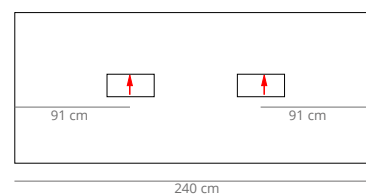

240 D

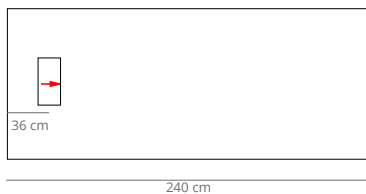

NOTE: ↑ The arrow points out the opening side

SQUARED TABLES

140 A

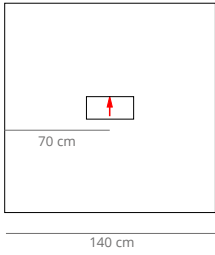

140 B

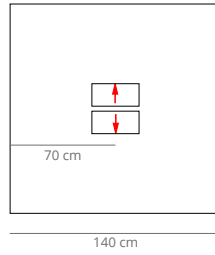

160 A

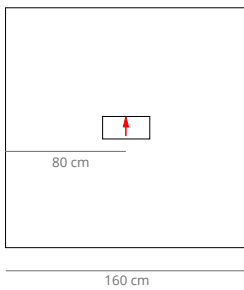

160 B

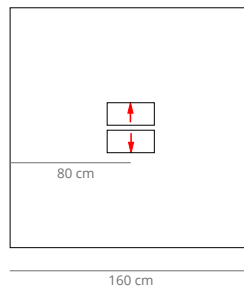

CUSTOM POSITIONS

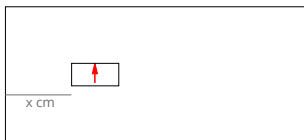

If the desired position for the power option is not among the suggested, please contact with sales department for assesstment.

NOTE: ↑ The arrow points out the opening side



Cambio

BY VICTOR CARRASCO

TABLES

Defined by a singular central base with a seamless silhouette, Cambio is a minimalist game of geometry based on the transition from a square to a round shape, taking us back to our origins.

A modern table collection that allows to create infinite compositions and accommodate multiple guests with its tabletops of up to 2 meters long and discreet electrification options.

Central base in rotomoulded polyethylene available in white, black or taupe. It allows electrification elements to be added in the centre of the tabletop thanks to the internal cable ducting.

The table top is available in 30mm thick MDF, with a technical microtextured lacquered finish in the colours of our collection that gives it great scratch resistance, or veneered in natural oak stained in matt, cognac, ash, bleached or walnut.

Also available in high resistance materials for severe use in Contract such as 19mm Melamine or 12mm Compact.

NOTE: We can offer the possibility to ship the tables without counterweight.

There is no option to install the tables without the recommended counterweight.

For more detailed information please contact the Sales Department.

NOTE 2: For tables equal to, or longer than 240 cm, the production delay is two additional weeks respect the normal production term.

Thickness and type of table top edges available for each material:

More table top information on page 21

MDF (stained / laquered)

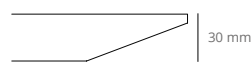

Melamine



Compact

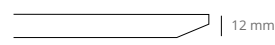

The total size of the compact and melamine tabletops may vary by ±1cm.

BASE 50 H45

Suitable top sizes:

D60 - D70 - D80 - D100
- D120 | 70x70 - 80x80
- 90x90

Counterweight:

48 kg

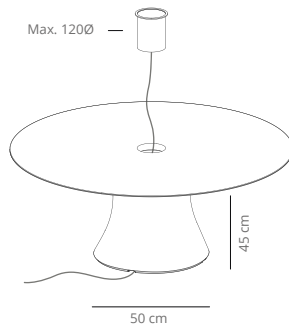

BASE 40 H71

Suitable top sizes:

D60 - D70 - D80 - D100
| 70x70

Counterweight:

36 kg

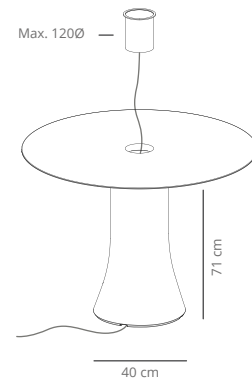

BASE 50 H71

Suitable top sizes:

D120 | 80x80 - 90x90 -
240x120

Counterweight:

48 kg

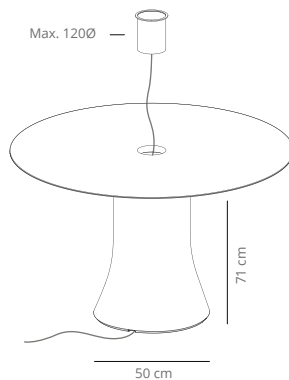

BASE 65 H71

Suitable top sizes:

D150 - D180 - D200 |
140x140 - 300x150 -
500x150

Counterweight:

74 kg

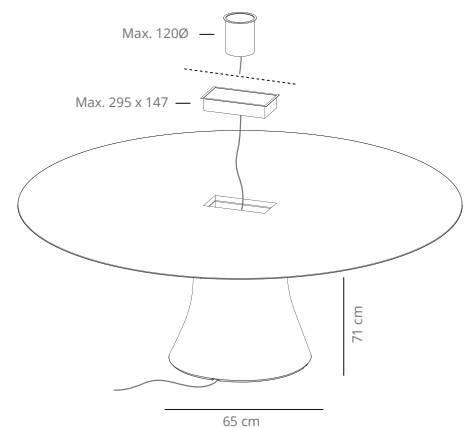

HEIGHT 48

Test certificate: UNE-EN 15372:2017, UNE-EN 527-1:2011, UNE-EN 527-2:2017 A1:2019 y ANSI BIFMA X5.5:20211

Table diameter 60

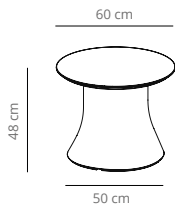

66.7 kg
 (x1) 59x55x58 cm (0.2 m³)
 (x1) 76x76x7 cm (0.04 m³)

CODE		FINISHES		PUBLIC PRICE	
		BASE	TOP		
VCBCAD60BM	CAD60BM	white, black or taupe	melamine	white or black	3.068 DKK
VCBCAD60B	CAD60B		stained oak	matt oak, cognac, ash, bleached oak or walnut	4.153 DKK
	CAD60BTX		lacquered (microtexturized)	white or black	4.102 DKK
taupe, brick, ochre, olive green, dusty pink or dusty green				4.204 DKK	
VCBCAD60BL	CAD60BCN		compact laminate (black edge)	black	3.661 DKK
	CAD60BCB		compact laminate (white edge)	white	4.246 DKK
VCBCAD60BHPL	CAD60BHPLN		HPL Soft Touch by Fenix with MDF	black	4.034 DKK
	CAD60BHPLB		HPL with MDF	white	4.034 DKK

Suggested maximum number of seats per table, calculated with an Aleta chair. The number of seats may vary depending on the chair model.

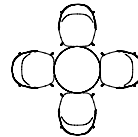
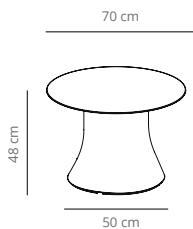

Table diameter 70



67.4 kg
 (x1) 59x55x58 cm (0.2 m³)
 (x1) 96x96x7 cm (0.06 m³)

CODE		FINISHES		PUBLIC PRICE	
		BASE	TOP		
VCBCAD70BM	CAD70BM	white, black or taupe	melamine	white or black	3.170 DKK
VCBCAD70B	CAD70B		stained oak	matt oak, cognac, ash, bleached oak or walnut	4.449 DKK
	CAD70BTX		lacquered (microtexturized)	white or black	4.153 DKK
taupe, brick, ochre, olive green, dusty pink or dusty green				4.246 DKK	
VCBCAD70BL	CAD70BCN		compact laminate (black edge)	black	3.856 DKK
	CAD70BCB		compact laminate (white edge)	white	4.653 DKK
VCBCAD70BHPL	CAD70BHPLN		HPL Soft Touch by Fenix with MDF	black	4.424 DKK
	CAD70BHPLB		HPL with MDF	white	4.424 DKK

Suggested maximum number of seats per table, calculated with an Aleta chair. The number of seats may vary depending on the chair model.

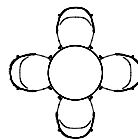

TABLES

Test certificate: UNE-EN 15372:2017, UNE-EN 527-1:2011, UNE-EN 527-2:2017 A1:2019 y ANSI BIFMA X5.5:20211

Table diameter 80

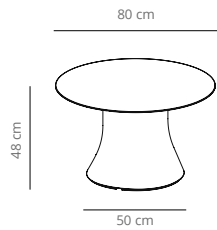

71.3 kg
 (x1) 59x55x58 cm (0.2 m³)
 (x1) 96x96x7 cm (0.06 m³)

CODE		BASE	FINISHES		PUBLIC PRICE
			TOP		
VCBCAD80BM	CAD80BM	white, black or taupe	melamine	white or black	3.314 DKK
VCBCAD80B	CAD80B		stained oak	matt oak, cognac, ash, bleached oak or walnut	4.695 DKK
	CAD80BTX		lacquered (microtexturized)	white or black	4.492 DKK
taupe, brick, ochre, olive green, dusty pink or dusty green				4.593 DKK	
VCBCAD80BL	CAD80BCN		compact laminate (black edge)	black	4.051 DKK
	CAD80BCB		compact laminate (white edge)	white	5.043 DKK
VCBCAD80BHPL	CAD80BHPLN		HPL Soft Touch by Fenix with MDF	black	4.788 DKK
	CAD80BHPLB		HPL with MDF	white	4.788 DKK

Suggested maximum number of seats per table, calculated with an Aleta chair. The number of seats may vary depending on the chair model.

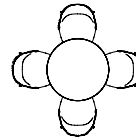
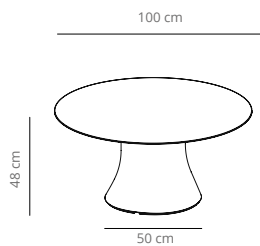

Table diameter 100



78.4 kg
 (x1) 59x55x58 cm (0.2 m³)
 (x1) 116x116x7 cm (0.09 m³)

CODE		BASE	FINISHES		PUBLIC PRICE
			TOP		
VCBCAD100BM	CAD100BM	white, black or taupe	melamine	white or black	3.754 DKK
VCBCAD100B	CAD100B		stained oak	matt oak, cognac, ash, bleached oak or walnut	6.280 DKK
	CAD100BTX		lacquered (microtexturized)	white or black	5.585 DKK
taupe, brick, ochre, olive green, dusty pink or dusty green				5.695 DKK	
VCBCAD100BL	CAD100BCN		compact laminate (black edge)	black	4.941 DKK
	CAD100BCB		compact laminate (white edge)	white	6.670 DKK
VCBCAD100BHPL	CAD100BHPLN		HPL Soft Touch by Fenix with MDF	black	6.339 DKK
	CAD100BHPLB		HPL with MDF	white	6.339 DKK

Suggested maximum number of seats per table, calculated with an Aleta chair. The number of seats may vary depending on the chair model.

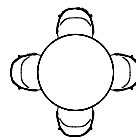

Test certificate: UNE-EN 15372:2017, UNE-EN 527-1:2011, UNE-EN 527-2:2017 A1:2019 y ANSI BIFMA X5.5:20211

Table diameter 120

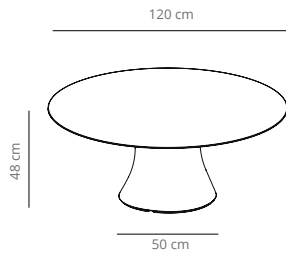

87.6 kg
 (x1) 59x55x58 cm (0.2 m³)
 (x1) 136x136x7 cm (0.13 m³)

CODE		BASE	FINISHES		PUBLIC PRICE
			TOP		
VCBCAD120BM	CAD120BM	white, black or taupe	melamine	white or black	4.102 DKK
VCBCAD120B	CAD120B		stained oak	matt oak, cognac, ash, bleached oak or walnut	8.009 DKK
	CAD120BTX		lacquered (microtexturized)	white or black	7.416 DKK
taupe, brick, ochre, olive green, dusty pink or dusty green				7.517 DKK	
VCBCAD120BL	CAD120BCN		compact laminate (black edge)	black	7.017 DKK
	CAD120BCB		compact laminate (white edge)	white	9.390 DKK
VCBCAD120BHPL	CAD120BHPLN		HPL Soft Touch by Fenix with MDF	black	8.924 DKK
	CAD120BHPLB		HPL with MDF	white	8.924 DKK

Suggested maximum number of seats per table, calculated with an Aleta chair. The number of seats may vary depending on the chair model.

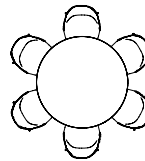
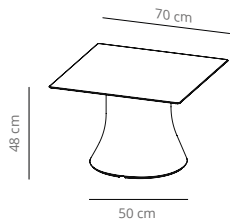

Table 70x70



70.8 kg
 (x1) 59x55x58 cm (0.2 m³)
 (x1) 76x76x7 cm (0.04 m³)

CODE		BASE	FINISHES		PUBLIC PRICE
			TOP		
VCBCAC70BM	CAC70BM	white, black or taupe	melamine	white or black	3.110 DKK
VCBCAC70B	CAC70B		stained oak	matt oak, cognac, ash, bleached oak or walnut	4.899 DKK
	CAC70BTX		lacquered (microtexturized)	white or black	4.797 DKK
taupe, brick, ochre, olive green, dusty pink or dusty green				4.899 DKK	
VCBCAC70BL	CAC70BCN		compact laminate (black edge)	black	4.399 DKK
	CAC70BCB		compact laminate (white edge)	white	4.890 DKK
VCBCAC70BHPL	CAC70BHPLN		HPL Soft Touch by Fenix with MDF	black	4.644 DKK
	CAC70BHPLB		HPL with MDF	white	4.644 DKK

Suggested maximum number of seats per table, calculated with an Aleta chair. The number of seats may vary depending on the chair model.

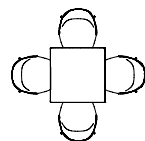

NOTE: The melamine tops come in a square shape, not in a rounded corner shape.

TABLES

Test certificate: UNE-EN 15372:2017, UNE-EN 527-1:2011, UNE-EN 527-2:2017 A1:2019 y ANSI BIFMA X5.5:20211

Table 80x80

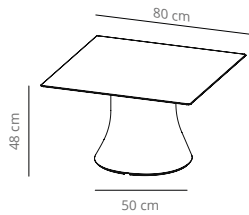

71.3 kg
 (x1) 59x55x58 cm (0.2 m³)
 (x1) 96x96x7 cm (0.06 m³)

CODE		BASE	FINISHES		PUBLIC PRICE
			TOP		
VCBCAC80BM	CAC80BM	white, black or taupe	melamine	white or black	3.314 DKK
VCBCAC80B	CAC80B		stained oak	matt oak, cognac, ash, bleached oak or walnut	5.585 DKK
	CAC80BTX		lacquered (microtexturized)	white or black	5.390 DKK
taupe, brick, ochre, olive green, dusty pink or dusty green				5.483 DKK	
VCBCAC80BL	CAC80BCN		compact laminate (black edge)	black	4.738 DKK
	CAC80BCB		compact laminate (white edge)	white	6.026 DKK
VCBCAC80BHPL	CAC80BHPLN		HPL Soft Touch by Fenix with MDF	black	5.721 DKK
	CAC80BHPLB		HPL with MDF	white	5.721 DKK

Suggested maximum number of seats per table, calculated with an Aleta chair. The number of seats may vary depending on the chair model.

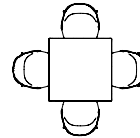

NOTE: The melamine tops come in a square shape, not in a rounded corner shape.

Table 90x90

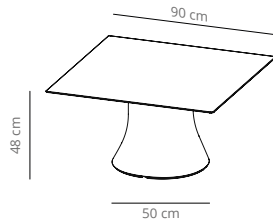

73.8 kg
 (x1) 59x55x58 cm (0.2 m³)
 (x1) 96x96x7 cm (0.06 m³)

CODE		BASE	FINISHES		PUBLIC PRICE
			TOP		
VCBCAC90BM	CAC90BM	white, black or taupe	melamine	white or black	3.559 DKK
VCBCAC90B	CAC90B		stained oak	matt oak, cognac, ash, bleached oak or walnut	6.424 DKK
	CAC90BTX		lacquered (microtexturized)	white or black	6.382 DKK
taupe, brick, ochre, olive green, dusty pink or dusty green				6.475 DKK	
VCBCAC90BL	CAC90BCN		compact laminate (black edge)	black	5.534 DKK
	CAC90BCB		compact laminate (white edge)	white	6.755 DKK
VCBCAC90BHPL	CAC90BHPLN		HPL Soft Touch by Fenix with MDF	black	6.416 DKK
	CAC90BHPLB		HPL with MDF	white	6.416 DKK

Suggested maximum number of seats per table, calculated with an Aleta chair. The number of seats may vary depending on the chair model.

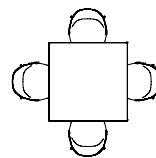

NOTE: The melamine tops come in a square shape, not in a rounded corner shape.

HEIGHT 74

Test certificate: UNE-EN 15372:2017 y ANSI BIFMA X5.5:2021

Table diameter 60

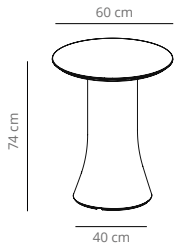

57.2 kg
 (x1) 59x55x89 cm (0.29 m³)
 (x1) 76x76x7 cm (0.04 m³)

CODE		FINISHES		PUBLIC PRICE	
		BASE	TOP		
VCBCAD60M	CAD60M	white, black or taupe	melamine	white or black	3.110 DKK
VCBCAD60	CAD60		stained oak	matt oak, cognac, ash, bleached oak or walnut	4.102 DKK
	CAD60TX		lacquered (microtexturized)	white or black	4.153 DKK
taupe, brick, ochre, olive green, dusty pink or dusty green				4.246 DKK	
VCBCAD60L	CAD60CN		compact laminate (black edge)	black	3.704 DKK
	CAD60CB		compact laminate (white edge)	white	4.305 DKK
VCBCAD60HPL	CAD60HPLN		HPL Soft Touch by Fenix with MDF	black	4.093 DKK
	CAD60HPLB		HPL with MDF	white	4.093 DKK

Suggested maximum number of seats per table, calculated with an Aleta chair. The number of seats may vary depending on the chair model.

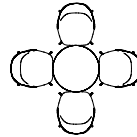
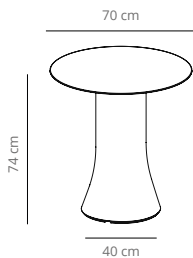

Table diameter 70



57.9 kg
 (x1) 59x55x89 cm (0.29 m³)
 (x1) 96x96x7 cm (0.06 m³)

CODE		FINISHES		PUBLIC PRICE	
		BASE	TOP		
VCBCAD70M	CAD70M	white, black or taupe	melamine	white or black	3.254 DKK
VCBCAD70	CAD70		stained oak	matt oak, cognac, ash, bleached oak or walnut	4.551 DKK
	CAD70TX		lacquered (microtexturized)	white or black	4.449 DKK
taupe, brick, ochre, olive green, dusty pink or dusty green				4.551 DKK	
VCBCAD70L	CAD70CN		compact laminate (black edge)	black	4.051 DKK
	CAD70CB		compact laminate (white edge)	white	4.839 DKK
VCBCAD70HPL	CAD70HPLN		HPL Soft Touch by Fenix with MDF	black	4.593 DKK
	CAD70HPLB		HPL with MDF	white	4.593 DKK

Suggested maximum number of seats per table, calculated with an Aleta chair. The number of seats may vary depending on the chair model.

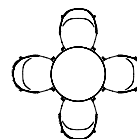

TABLES

Test certificate: UNE-EN 15372:2017 y ANSI BIFMA X5.5:2021

Table diameter 80

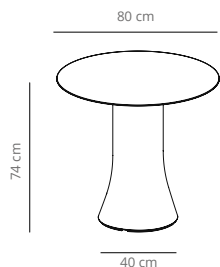

- 61.8 kg
- (x1) 59x55x89cm (0.29 m³)
- (x1) 96x96x7cm (0.06 m³)

CODE		FINISHES		PUBLIC PRICE	
		BASE	TOP		
VCBCAD80M	CAD80M	white, black or taupe	melamine	white or black	3.458 DKK
VCBCAD80	CAD80		stained oak	matt oak, cognac, ash, bleached oak or walnut	5.043 DKK
	CAD80TX		lacquered (microtexturized)	white or black	4.738 DKK
taupe, brick, ochre, olive green, dusty pink or dusty green				4.839 DKK	
VCBCAD80L	CAD80CN		compact laminate (black edge)	black	4.348 DKK
	CAD80CB		compact laminate (white edge)	white	5.144 DKK
VCBCAD80HPL	CAD80HPLN		HPL Soft Touch by Fenix with MDF	black	4.890 DKK
	CAD80HPLB		HPL with MDF	white	4.890 DKK

Suggested maximum number of seats per table, calculated with an Aleta chair. The number of seats may vary depending on the chair model.

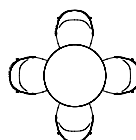
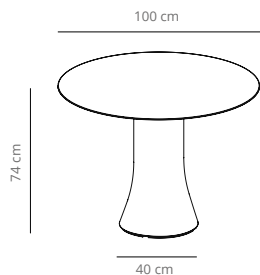

Table diameter 100



- 68.9 kg
- (x1) 59x55x89 cm (0.29 m³)
- (x1) 116x116x7 cm (0.09 m³)

CODE		FINISHES		PUBLIC PRICE	
		BASE	TOP		
VCBCAD100M	CAD100M	white, black or taupe	melamine	white or black	4.102 DKK
VCBCAD100	CAD100		stained oak	matt oak, cognac, ash, bleached oak or walnut	6.136 DKK
	CAD100TX		lacquered (microtexturized)	white or black	5.831 DKK
taupe, brick, ochre, olive green, dusty pink or dusty green				5.932 DKK	
VCBCAD100L	CAD100CN		compact laminate (black edge)	black	5.144 DKK
	CAD100CB		compact laminate (white edge)	white	6.136 DKK
VCBCAD100HPL	CAD100HPLN		HPL Soft Touch by Fenix with MDF	black	5.831 DKK
	CAD100HPLB		HPL with MDF	white	5.831 DKK

Suggested maximum number of seats per table, calculated with an Aleta chair. The number of seats may vary depending on the chair model.

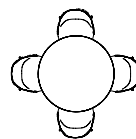

Test certificate: UNE-EN 15372:2017 y ANSI BIFMA X5.5:2021

Table diameter 120

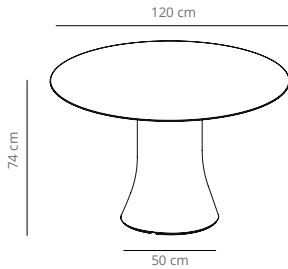

- 89.6 kg
- (x1) 59x55x89cm (0.29 m³)
- (x1) 136x136x7 cm (0.13 m³)

CODE		FINISHES		PUBLIC PRICE	
		BASE	TOP		
VCBCAD120M	CAD120M	white, black or taupe	melamine	white or black	4.153 DKK
VCBCAD120	CAD120		stained oak	matt oak, cognac, ash, bleached oak or walnut	8.153 DKK
	CAD120TX		lacquered (microtexturized)	white or black	6.526 DKK
taupe, brick, ochre, olive green, dusty pink or dusty green				6.627 DKK	
VCBCAD120L	CAD120CN		compact laminate (black edge)	black	6.822 DKK
	CAD120CB		compact laminate (white edge)	white	8.009 DKK
VCBCAD120HPL	CAD120HPLN		HPL Soft Touch by Fenix with MDF	black	7.611 DKK
	CAD120HPLB		HPL with MDF	white	7.611 DKK

Suggested maximum number of seats per table, calculated with an Aleta chair. The number of seats may vary depending on the chair model.

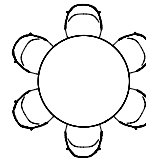
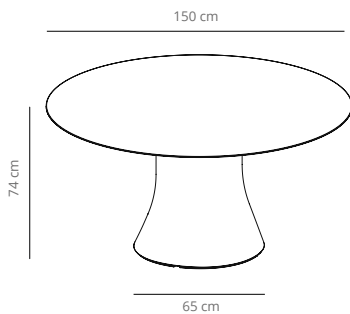

Table diameter 150



- 133 kg
- (x1) 82x82x77 cm (0.5 m³)
- (x1) 178x166x7 cm (0.21 m³)

CODE		FINISHES		PUBLIC PRICE	
		BASE	TOP		
VCBCAD150M	CAD150M	white, black or taupe	melamine	white or black	7.416 DKK
VCBCAD150	CAD150		stained oak	matt oak, cognac, ash, bleached oak or walnut	11.763 DKK
	CAD150TX		lacquered (microtexturized)	white or black	10.873 DKK
taupe, brick, ochre, olive green, dusty pink or dusty green				10.975 DKK	
VCBCAD150L	CAD150CN		compact laminate (black edge)	black	10.772 DKK
	CAD150CB		compact laminate (white edge)	white	12.255 DKK

Suggested maximum number of seats per table, calculated with an Aleta chair. The number of seats may vary depending on the chair model.

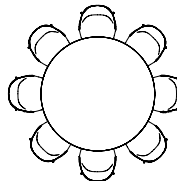

TABLES

Test certificate: UNE-EN 15372:2017 y ANSI BIFMA X5.5:2021

Table diameter 180

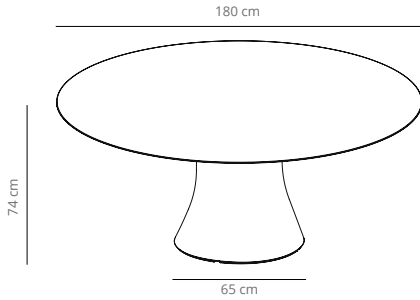

- 153 kg
- (x1) 82x82x77 cm (0.5 m³)
- (x1)

CODE		FINISHES			PUBLIC PRICE
		BASE	TOP		
VCBCAD180M	CAD180M	white, black or taupe	melamine	white or black	8.695 DKK
VCBCAD180	CAD180		stained oak	matt oak, cognac, ash, bleached oak or walnut	15.526 DKK
	CAD180TX		lacquered (microtexturized)	white or black	14.136 DKK
taupe, brick, ochre, olive green, dusty pin or dusty green				14.230 DKK	
VCBCAD180L	CAD180CN		compact laminate (black edge)	black	15.323 DKK
	CAD180CB		compact laminate (white edge)	white	23.230 DKK

Suggested maximum number of seats per table, calculated with an Aleta chair. The number of seats may vary depending on the chair model.

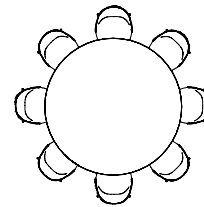

NOTE: The melamine tops come in a square shape, not in a rounded corner shape.

Table diameter 200

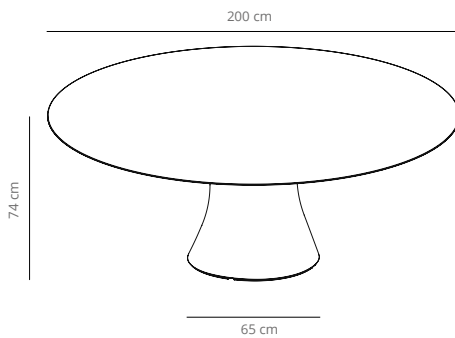

- (x1) 82x82x77 cm (0.5 m³)
- (x1)

CODE		FINISHES			PUBLIC PRICE
		BASE	TOP		
VCBCAD200	CAD200	white, black or taupe	stained oak	matt oak, cognac, ash, bleached oak or walnut	19.476 DKK
	CAD200TX		lacquered (microtexturized)	white or black	15.221 DKK
taupe, brick, ochre, olive green, dusty pin or dusty green				15.323 DKK	

Suggested maximum number of seats per table, calculated with an Aleta chair. The number of seats may vary depending on the chair model.

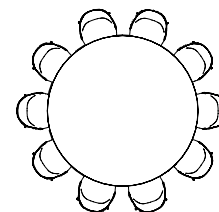

NOTE: The melamine tops come in a square shape, not in a rounded corner shape.

Test certificate: UNE-EN 15372:2017, UNE-EN 527-1:2011, UNE-EN 527-2:2017 A1:2019 y ANSI BIFMA X5.5:20211

Table 70x70

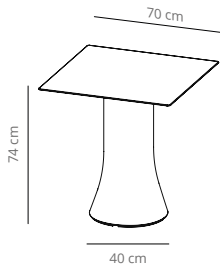

61.3 kg
 (x1) 59x55x89 cm (0.29 m³)
 (x1) 76x76x7 cm (0.04 m³)

CODE		FINISHES		PUBLIC PRICE	
		BASE	TOP		
VCBCAC70M	CAC70M	white, black or taupe	melamine	white or black	3.314 DKK
VCBCAC70	CAC70		stained oak	matt oak, cognac, ash, bleached oak or walnut	4.653 DKK
	CAC70TX		lacquered (microtexturized)	white or black	4.449 DKK
taupe, brick, ochre, olive green, dusty pink or dusty green				4.551 DKK	
VCBCAC70L	CAC70CN		compact laminate (black edge)	black	4.051 DKK
	CAC70CB		compact laminate (white edge)	white	4.738 DKK
VCBCAC70HPL	CAC70HPLN		HPL Soft Touch by Fenix with MDF	black	4.500 DKK
	CAC70HPLB		HPL with MDF	white	4.500 DKK

Suggested maximum number of seats per table, calculated with an Aleta chair. The number of seats may vary depending on the chair model.

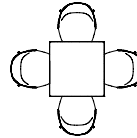

NOTE: The melamine tops come in a square shape, not in a rounded corner shape.

Table 80x80

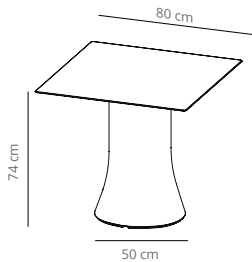

73.3 kg
 (x1) 59x55x89 cm (0.29 m³)
 (x1) 96x96x7 cm (0.06 m³)

CODE		FINISHES		PUBLIC PRICE	
		BASE	TOP		
VCBCAC80M	CAC80M	white, black or taupe	melamine	white or black	3.415 DKK
VCBCAC80	CAC80		stained oak	matt oak, cognac, ash, bleached oak or walnut	4.924 DKK
	CAC80TX		lacquered (microtexturized)	white or black	4.797 DKK
taupe, brick, ochre, olive green, dusty pink or dusty green				4.899 DKK	
VCBCAC80L	CAC80CN		compact laminate (black edge)	black	4.305 DKK
	CAC80CB		compact laminate (white edge)	white	5.085 DKK
VCBCAC80HPL	CAC80HPLN		HPL Soft Touch by Fenix with MDF	black	4.831 DKK
	CAC80HPLB		HPL with MDF	white	4.831 DKK

Suggested maximum number of seats per table, calculated with an Aleta chair. The number of seats may vary depending on the chair model.

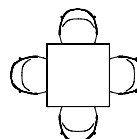

NOTE: The melamine tops come in a square shape, not in a rounded corner shape.

TABLES

Test certificate: UNE-EN 15372:2017, UNE-EN 527-1:2011, UNE-EN 527-2:2017 A1:2019 y ANSI BIFMA X5.5:20211

Table 90x90

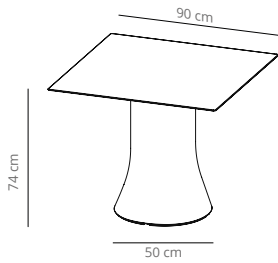

75.8 kg
 (x1) 59x55x89 cm (0.29 m³)
 (x1) 96x96x7 cm (0.06 m³)

CODE		FINISHES		PUBLIC PRICE	
		BASE	TOP		
VCBCAC90M	CAC90M	white, black or taupe	melamine	white or black	3.610 DKK
VCBCAC90	CAC90		stained oak	matt oak, cognac, ash, bleached oak or walnut	6.034 DKK
	CAC90TX		lacquered (microtexturized)	white or black	5.238 DKK
taupe, brick, ochre, olive green, dusty pink or dusty green				5.339 DKK	
VCBCAC90L	CAC90CN		compact laminate (black edge)	black	4.899 DKK
	CAC90CB		compact laminate (white edge)	white	6.178 DKK
VCBCAC90HPL	CAC90HPLN		HPL Soft Touch by Fenix with MDF	black	5.873 DKK
	CAC90HPLB		HPL with MDF	white	5.873 DKK

Suggested maximum number of seats per table, calculated with an Aleta chair. The number of seats may vary depending on the chair model.

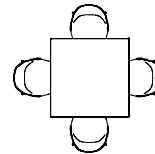

NOTE: The melamine tops come in a square shape, not in a rounded corner shape.

Table 140x140

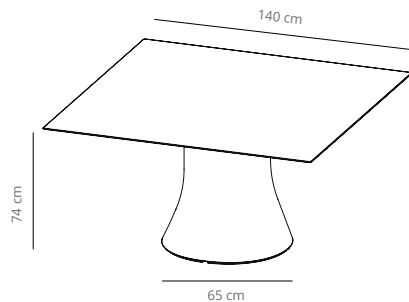

113.8 kg
 (x1) 82x82x77 cm (0.5 m³)
 (x1) 147x147x7 cm (0.15 m³)

CODE		FINISHES		PUBLIC PRICE	
		BASE	TOP		
VCBCAC140M	CAC140M	white, black or taupe	melamine	white or black	7.416 DKK
VCBCAC140	CAC140		stained oak	matt oak, cognac, ash, bleached oak or walnut	11.077 DKK
	CAC140TX		lacquered (microtexturized)	white or black	10.382 DKK
taupe, brick, ochre, olive green, dusty pink or dusty green				10.484 DKK	
VCBCAC140L	CAC140CN		compact laminate (black edge)	black	9.984 DKK
	CAC140CB		compact laminate (white edge)	white	15.323 DKK

Suggested maximum number of seats per table, calculated with an Aleta chair. The number of seats may vary depending on the chair model.

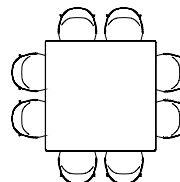

NOTE: The melamine tops come in a square shape, not in a rounded corner shape.

Cambio

2022, BY VICTOR CARRASCO

TABLES

Test certificate: UNE-EN 15372:2017, UNE-EN 527-1:2011, UNE-EN 527-2:2017 A1:2019 y ANSI BIFMA X5.5:2021

Table 240x120

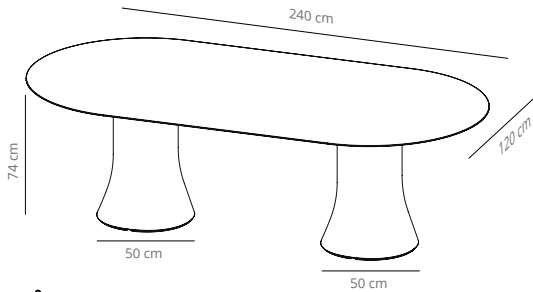

- 📦 258 kg
- 📦 (x2) 59x55x89 cm (0.29 m³)
- 📦 (x1) 267x149x27 cm (1.07 m³)

CODE		FINISHES		PUBLIC PRICE	
		BASE	TOP		
VCBCAC240	CAC240	white, black or taupe	stained oak	matt oak, cognac ash, bleached oak or walnut	16.357 DKK
	CAC240TX		lacquered (microtexturized)	white or black	15.026 DKK
taupe, brick, ochre, olive green, dusty pin or dusty green				15.119 DKK	
VCBCAC240L	CAC240CN		compact laminate (black edge)	black	16.314 DKK
	CAC240CB	compact laminate (white edge)	white	23.577 DKK	

Suggested maximum number of seats per table, calculated with an Aleta chair. The number of seats may vary depending on the chair model.

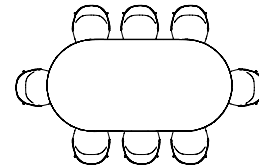
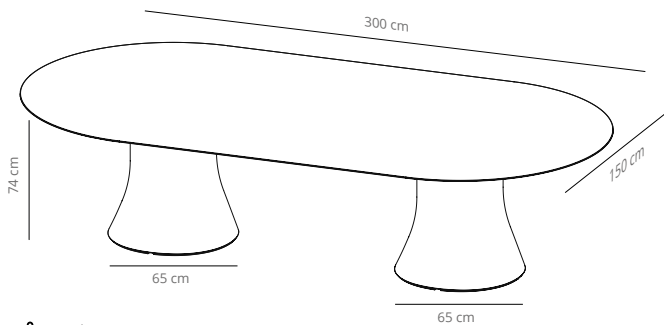

Table 300x150



- 📦 331 kg
- 📦 (x2) 82x82x77 cm (0.5 m³)
- 📦 (x1) 330x180x27 cm (1.6 m³)

CODE		FINISHES		PUBLIC PRICE	
		BASE	TOP		
VCBCAC300	CAC300	white, black or taupe	stained oak	matt oak, cognac ash, bleached oak or walnut	26.544 DKK
	CAC300TX		lacquered (microtexturized)	white or black	25.900 DKK
taupe, brick, ochre, olive green, dusty pin or dusty green				25.993 DKK	

Suggested maximum number of seats per table, calculated with an Aleta chair. The number of seats may vary depending on the chair model.

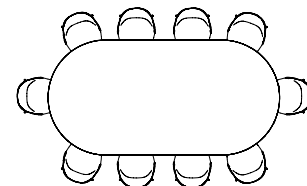

TABLES

Test certificate: UNE-EN 15372:2017, UNE-EN 527-1:2011, UNE-EN 527-2:2017 A1:2019 y ANSI BIFMA X5.5:2021

Table 500x150

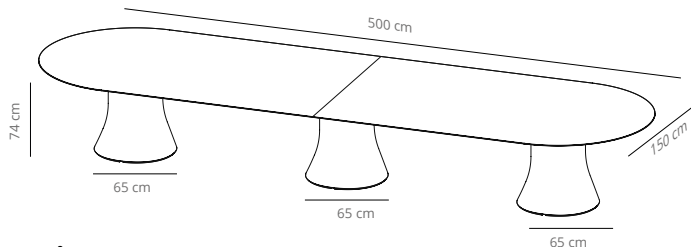

- 🏠 466 kg
- 📦 (x3) 82x82x77 cm (0.5 m³)
- 📦 (x2) 281x176x10 cm (0.49 m³)

CODE		FINISHES		PUBLIC PRICE	
		BASE	TOP		
VCBCAC500	CAC500	white, black or taupe	stained oak	matt oak, cognac ash, bleached oak or walnut	43.350 DKK
	CAC500TX		lacquered (microtexturized)	white or black	43.697 DKK
				taupe, brick, ochre, olive green, dusty pin or dusty green	43.790 DKK

Suggested maximum number of seats per table, calculated with an Aleta chair. The number of seats may vary depending on the chair model.

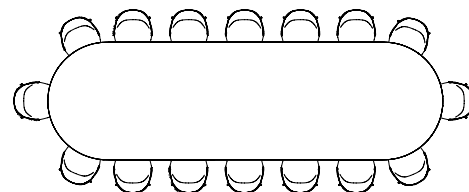

ACCESSORIES AND POWER OPTIONS

For the different table tops, we offer the possibility of installing the following accessories and power options. The drawings with the location of the accessories need the approval of the technical department.

NOTE: Power options not available for models CAC500 y CAC500TX if it interferes with the center column.

Cut out

CODE		PUBLIC PRICE
-	CAMEC	1.093 DKK

Custom table top measure. The price is per table top.

Pop-up sockets

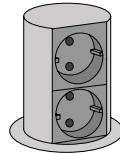

0.6 kg
(x1) 21x16x16cm (0.005 m³)

CODE		PUBLIC PRICE
-	CATC	3.009 DKK

Built-in pop-up socket cylinder can have 2 Schuko sockets or 1 Schuko socket + 2 USB hubs. For different configurations, contact the sales department. The cylinder is hidden and pops up by gently pressing on it, offering the possibility of connection on four sides.

*The finish can vary depending on the internal configuration. For more information, please contact our sales department.

NOTE: The cut out is included only if it is in the center of the base column.

USB hub

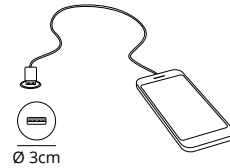

Installed and included in the table top box

CODE	FINISHES	PUBLIC PRICE	
-	CAUSB	black	525 DKK

Built-in USB hub for charging electronic devices, built in the tabletop. The cable length is 1.0 m with USB connection. Available in black or white. **Dimensions: Ø 3 cm**

NOTE: The cut out is included if it coincides with the center of the base column. It is not included for other positions.

Under table powerbox

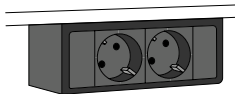

1.7 kg
(x1) 17x18x9cm (0.005 m³)

CODE	FINISHES	PUBLIC PRICE	
-	CAEL-E	black	2.814 DKK

Powerbox available with 2 sockets or combined with built-in multimedia devices

For all available power options *see page 505*.

NOTE: Not available for compact table tops.

Table top hatch



1.2 kg
(x1) 34x18x9cm (0.005 m³)

CODE	FINISHES	PUBLIC PRICE	
VCBCAP*	CAP*	white or black	1.246 DKK

Metallic hatch access to the lower part of the table. Available in white, black or grey. Does not include power options. **Dimensions: 32x15 cm**
* Cut out not included.

*NOTE: Not available for compact tabletops.
NOTE: Only available in the center of the table for models: CAD150, CAD180, CAD200, CAC140, CAC240, CAC300 y CAC500.*

Table top hatch plus

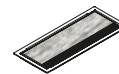

1.2 kg
(x1) 34x18x9cm (0.005 m³)

CODE	FINISHES	PUBLIC PRICE	
VCBCAPP*	CAPP*	black, grey	1.500 DKK

Metallic hatch access to the lower part of the table for wooden table tops. Metal frame available in black or grey and central part in the veneer of the finish of the table. Does not include power options. **Dimensions: 32x15 cm**
* Cut out not included.

*NOTE: Not available for compact tabletops.
NOTE: Only available in the center of the table for models: CAD150, CAD180, CAD200, CAC140, CAC240, CAC300 y CAC500.*

TABLES

Table top hatch powerbox

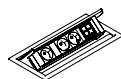

1.7 kg
(x1) 34x18x9cm (0.005 m³)

CODE		FINISHES	PUBLIC PRICE
-	BOX-E*	white or black	2.441 DKK
-	BOX-M*		3.534 DKK

BOX-E: 4 sockets
BOX-M: 4 devices (sockets and multimedia)

Metallic hatch with 4 sockets or combined with built-in multimedia devices.

Available in white, black or grey

Dimensions: 32x15 cm

* Cut out not included.

For all available power options *see page 505*.

NOTE: Not available for compact table tops.

NOTE: Only available for the models:

CAD150, CAD180, CAD200, CAC140, CAC240, CAC300 y CAC500.

Table top hatch powerbox plus



1.7 kg
(x1) 34x18x9cm (0.005 m³)

CODE		FINISHES	PUBLIC PRICE
-	BOXP-E*	black, grey	3.534 DKK
-	BOXP-M*		4.610 DKK

BOXP-E: 4 sockets
BOXP-M: 4 devices (sockets and multimedia)

Metallic hatch for wooden table tops with 4 sockets or combined with built-in multimedia devices. Metal frame available in black or grey and central part in the veneer of the finish of the table.

Dimensions: 32x15 cm

* Cut out not included.

For all available power options *see page 505*.

NOTE: Not available for compact table tops.

NOTE: Only available for the models:

CAD150, CAD180, CAD200, CAC140, CAC240, CAC300 y CAC500.

The references BOX-E, BOX-M, BOXP-E and BOXP-M have 4 modules (sockets or multimedia devices) to install power options. The modules can be complete (1) or half module. (1/2).

The power options are under the UNE-EN 50085 standards.

For the references BOX-E, BOX-M, BOXP-E, BOXP-M y CAEL-E the cable length is 0.3 meters with Wieland connector. The power connection cable is not included, and will have to be provided by the customer.

USB hub with battery

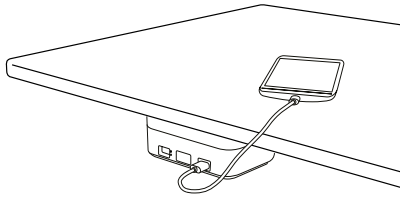

👤 1.4 kg
📦 (x1) 40x20x25cm (0.02 m3)

CODE		FINISHES	PUBLIC PRICE
-	CAEL-B	black	2.187 DKK

USB hub with two USB device charging ports without being plugged into electric current. It's needed to buy the battery charging tray to charge the USB hub battery.

Battery charging tray

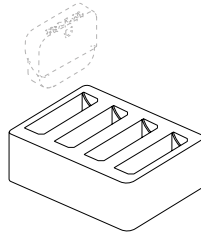

👤 1 kg
📦 (x1) 40x20x25cm (0.02 m3)

CODE		FINISHES	PUBLIC PRICE
-	CAEL-C	black	2.542 DKK

Battery charging tray. Charges up to four stations simultaneously in 7 hours. Includes magnetic key to remove the station from its support.

TABLES

POWER POSITION OPTIONS

We have curated a selection of cut out positions from the most demanded due to its polyvalence and flexibility. Please contact our sales team in case you need a quote for specials, we are open to listen to your needs. For other options, please contact the sales department, indicating the cut out reference in the order.

TABLES 40 x 120 cm

240 A

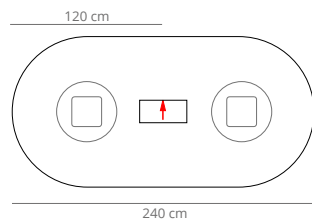

240 B

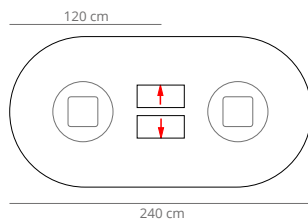

240 C

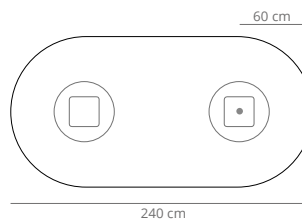

240 D

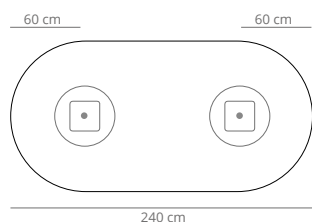

240 E

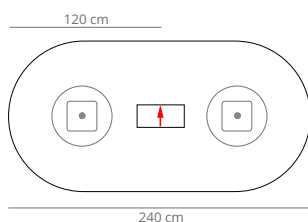

TABLES 300 x 150 cm

300 A

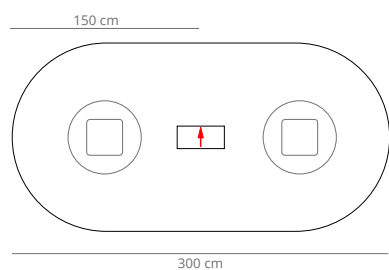

300 B

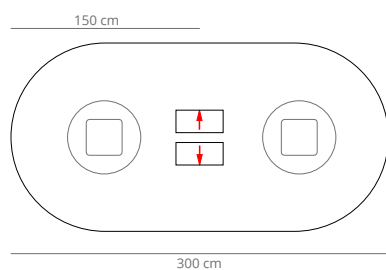

300 C

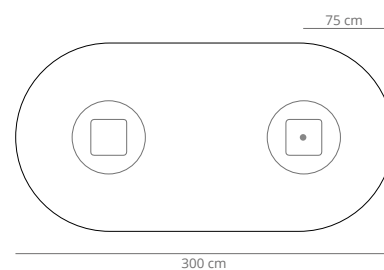

300 D

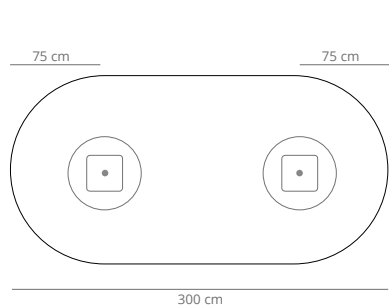

300 E

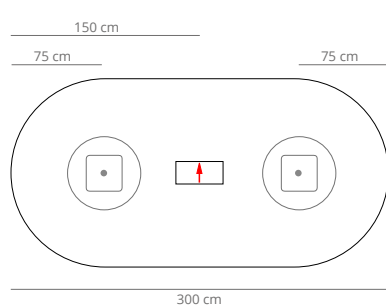

300 F

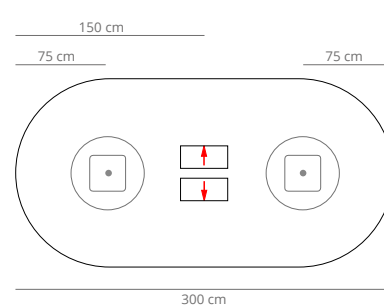

-  The rectangle represents a standard powerbox (32x15 cm), compatible with references CAP, CAPP, BOX-E, BOX-M, BOXP-E y BOXP-M. The arrow points out the opening side.
- The circle represents the column centered option for cut out and power options, only compatible for references CAMEC, CATC and CAUSB

300 G

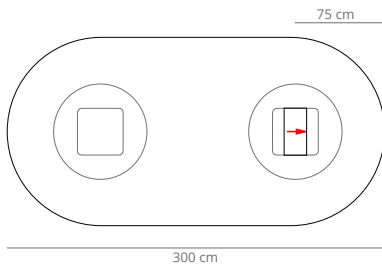

300 H

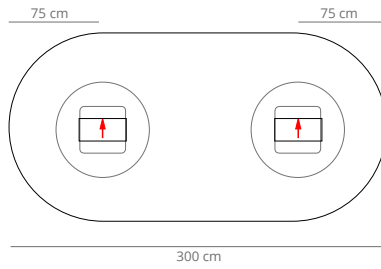

300 I

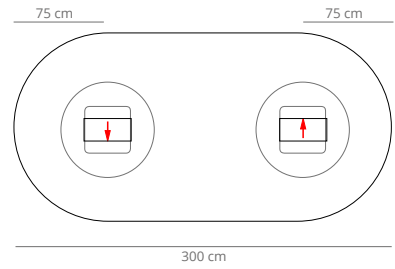

300 J

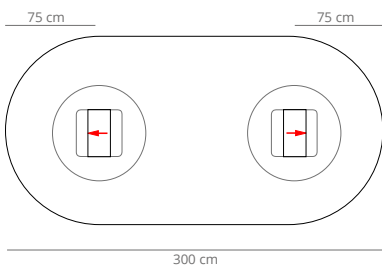

300 K

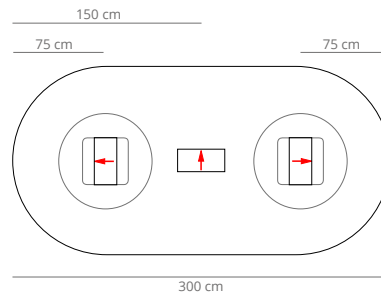

300 L

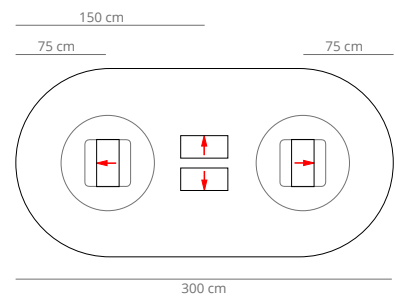

TABLES 500 x 150 cm

500 A

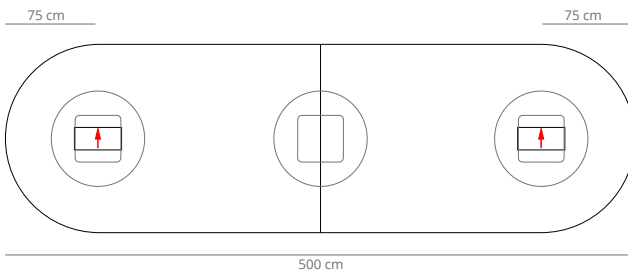

500 B

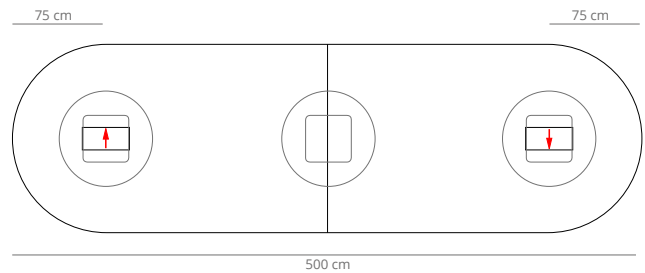

500 C

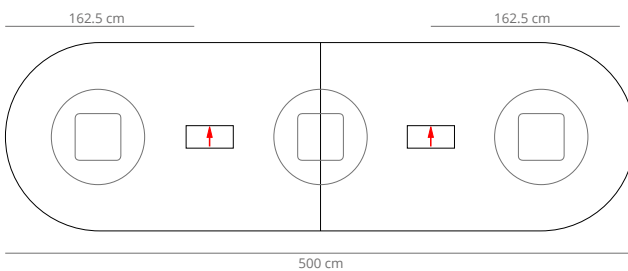

500 D

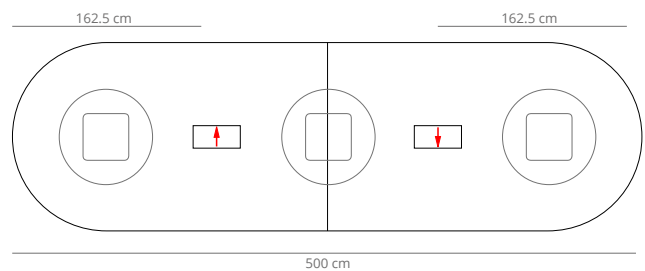

 The rectangle represents a standard powerbox (32x15 cm), compatible with references CAP, CAPP, BOX-E, BOX-M, BOXP-E y BOXP-M. The arrow points out the opening side.

- The circle represents the column centered option for cut out and power options, only compatible for references CAMEC, CATC and CAUSB

TABLES

500 E

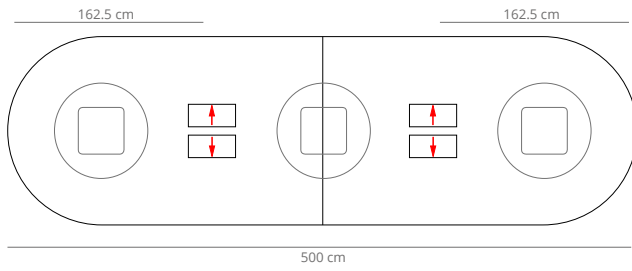

500 F

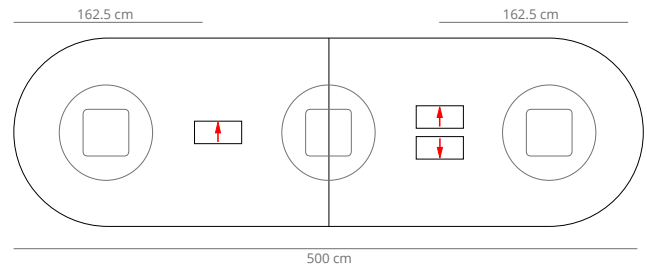

500 G

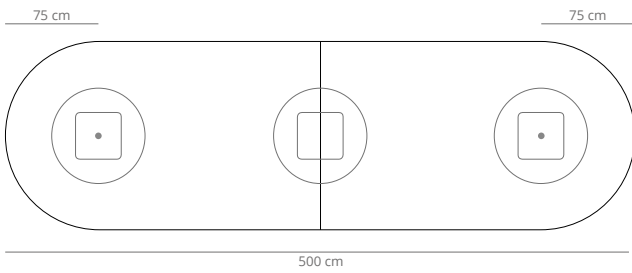

500 H

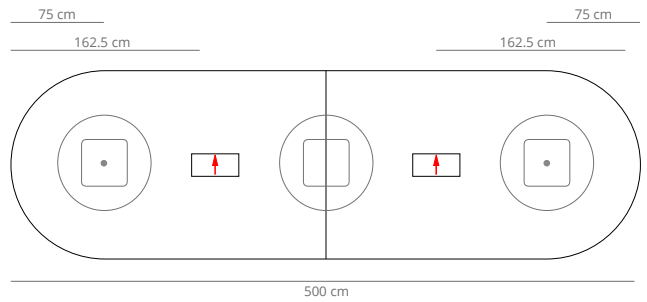

500 I

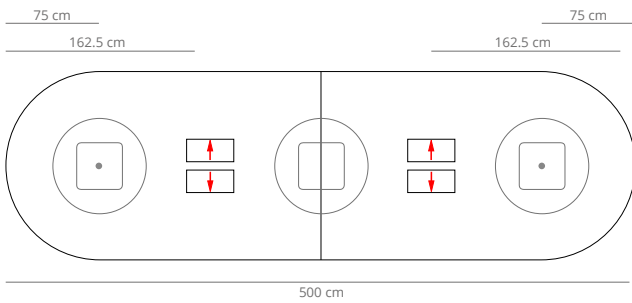

500 J

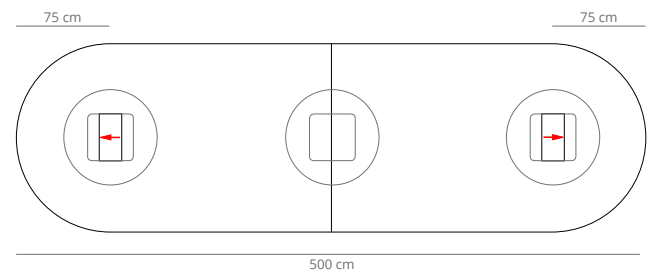

500 K

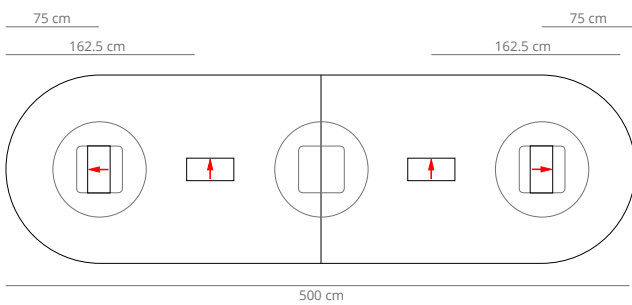

500 L

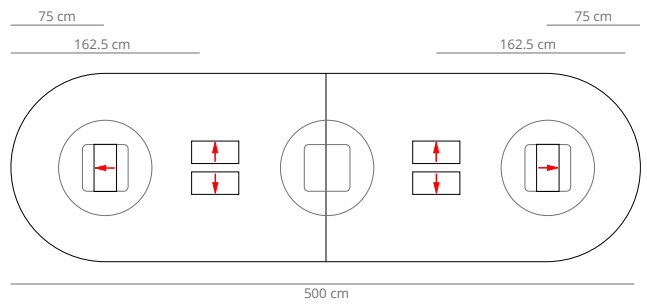

 The rectangle represents a standard powerbox (32x15 cm), compatible with references CAP, CAPP, BOX-E, BOX-M, BOXP-E y BOXP-M. The arrow points out the opening side.

- The circle represents the column centered option for cut out and power options, only compatible for references CAMEC, CATC and CAUSB



Solar

FOR MARC KRUSIN

TABLES

Test certificates: ANSI/BIFMA X5.4-2020 and UNE-EN 16139:2013vc2015

Solar is a disruptive table concept designed by Marc Krusin, which opens up new ways of working and collaborating.

It consists of a table with an integrated seat, which rotates according to the user's needs, ensuring collaboration but also privacy.

The structure is made of steel.

The table is made of MDF board or compact with the finishes of our

collection and the seat can be upholstered in any of the fabrics from our collection. It also includes a small hook, located under the tabletop, so that the user can keep their belongings close at all times. The maximum load for this hook is 15 kg.

A new concept of versatile table, suitable for public areas, offices, educational environments such as schools or universities, restaurants and coworking spaces.

tabletop thickness and edge shape:



More table top information on page 21

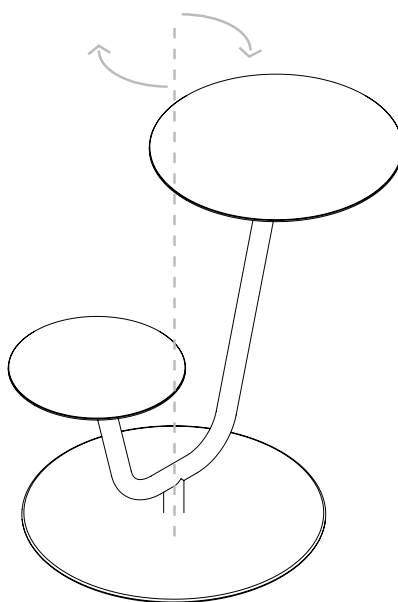

Includes hanger under tabletop

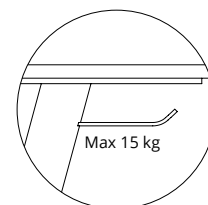

Anchored base to floor available

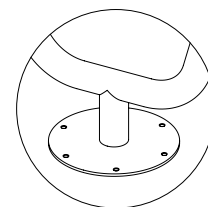

COLLABORATION

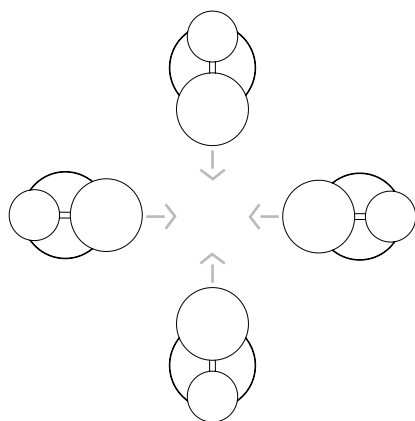

PRIVACY

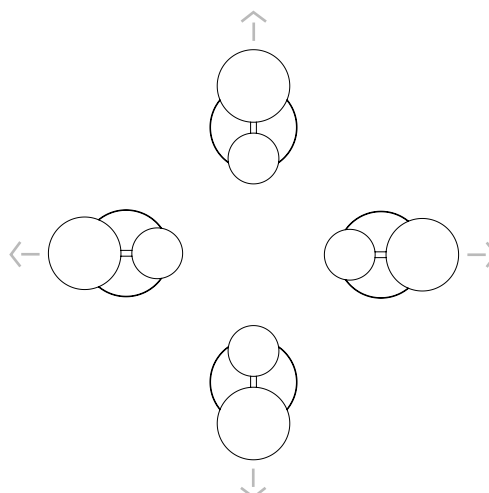

ANCHORED BASE

Compact seat

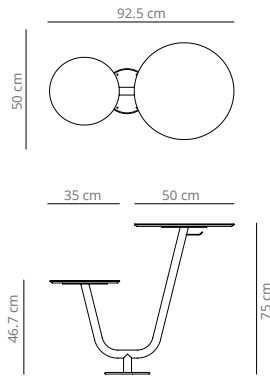

19.3 kg
 (x1) 78x78x23.5 cm (0.14 m³)

CODE	FINISHES			PUBLIC PRICE
	STRUCTURE	TOP	SEAT	
SOLANRON	black and white	matt oak, cognac, ash, bleached oak or walnut	black or white compact (black edge)	5.687 DKK
SOLANROB			white compact (white edge)	6.178 DKK
SOLANCN		black or white compact (black edge)		5.687 DKK
SOLANCB		white compact (white edge)		6.670 DKK

NOTE: This model can be combined with a table top and seat in different colours. In this case, the higher price compact will always be considered.

Needed fabric for material 1.40 m: 0.5 m

Upholstery seat

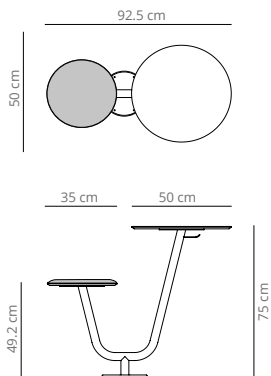

19.5 kg
 (x1) 78x78x23.5 cm (0.14 m³)

CODE	FINISHES			PUBLIC PRICE
	STRUCTURE	TOP	SEAT	
SOLANROT-1	black and white	matt oak, cognac, ash, bleached oak or walnut	G1 (T/C)	5.831 DKK
SOLANROT-2			G2	6.077 DKK
SOLANROT-3			G3	6.322 DKK
SOLANROT-4			G4	6.568 DKK
SOLANROT-5			G5	6.822 DKK
SOLANCNT-1		black or white compact (black edge)	G1 (T/C)	5.932 DKK
SOLANCNT-2			G2	6.178 DKK
SOLANCNT-3			G3	6.424 DKK
SOLANCNT-4			G4	6.670 DKK
SOLANCNT-5			G5	6.916 DKK
SOLANCBT-1		white compact (white edge)	G1 (T/C)	6.916 DKK
SOLANCBT-2			G2	7.170 DKK
SOLANCBT-3			G3	7.416 DKK
SOLANCBT-4			G4	7.661 DKK
SOLANCBT-5			G5	7.907 DKK

NOTE: Anchoring screws not included.

TABLES

FREE BASE

Compact seat

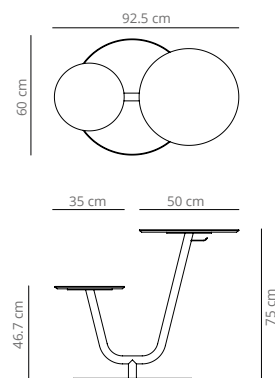

33.8 kg

(x1) 78x78x23.5 cm (0.14 m³)

Upholstered seat

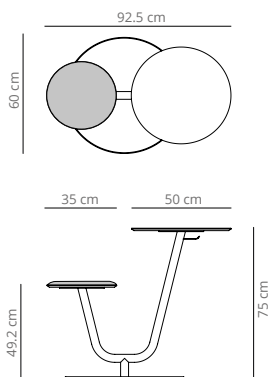

34 kg

(x1) 78x78x23.5 cm (0.14 m³)

CODE	FINISHES			PUBLIC PRICE
	STRUCTURE	TOP	SEAT	
SOLRON	black and white	matt oak, cognac, ash, bleached oak or walnut	black or white compact (black edge)	8.399 DKK
SOLROB			white compact (white edge)	8.746 DKK
SOLCN		black or white compact (black edge)		8.399 DKK
SOLCB		white compact (white edge)		9.492 DKK

NOTE: This model can be combined with a table top and seat in different colours. In this case, the higher price compact will always be considered.

Needed fabric for material
1.40 m wide: 0.5 m

CODE	FINISHES			PUBLIC PRICE
	STRUCTURE	TOP	SEAT	
SOLROT-1	black and white	matt oak, cognac, ash, bleached oak or walnut	G1 (COM/COL)	7.907 DKK
SOLROT-2			G2	8.153 DKK
SOLROT-3			G3	8.399 DKK
SOLROT-4			G4	8.653 DKK
SOLROT-5			G5	8.899 DKK
SOLCNT-1		black or white compact (black edge)	G1 (COM/COL)	8.009 DKK
SOLCNT-2			G2	8.255 DKK
SOLCNT-3			G3	8.500 DKK
SOLCNT-4			G4	8.746 DKK
SOLCNT-5			G5	9.000 DKK
SOLCBT-1	white compact (white edge)	G1 (COM/COL)	9.000 DKK	
SOLCBT-2		G2	9.246 DKK	
SOLCBT-3		G3	9.492 DKK	
SOLCBT-4		G4	9.738 DKK	
SOLCBT-5		G5	9.984 DKK	

POWER OPTIONS

USB hub with battery

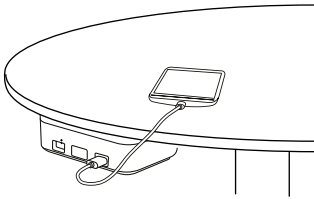

1.4 kg
 (x1) 40x20x25cm (0.02 m3)

CODE	FINISHES	PUBLIC PRICE
SOLEL-B	black	2.187 DKK

USB hub with two USB device charging ports without being plugged into electric current. It's needed to buy the battery charging tray to charge the USB hub battery.

Battery charging tray

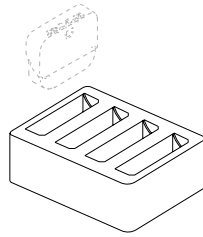

1 kg
 (x1) 40x20x25cm (0.02 m3)

CODE	FINISHES	PUBLIC PRICE
SOLEL-C	black	2.542 DKK

Battery charging tray. Charges up to four stations simultaneously in 7 hours. Includes magnetic key to remove the station from its support.



Maarten

BY VICTOR CARRASCO

TABLES

Test certificates: UNE-EN 527-1:2011, UNE EN 527-2:03, UNE-EN 527-3:03 and ANSI BIFMA x5.5:2014 (table height 74).

Maarten is a collection of tables and complements that allows m any compositions and finishes.

The legs, which come in heights of 30 or 74 cm, are made from calibrated steel, powder coated in thermoreinforced polyester. Available in white, black, fluorescent orange or a stained oak veneer with the finishes of our collection.

The 30 mm thick cover or work surface is made with microtextured MDF. It is lacquered with one of our collection's finishes, making it very scratch resistant. It also comes with a solid oak veneer, stained in mate, wenge, cognac or ash. Available in high resistance materials such as HPL with MDF for heavy contract use.

NOTE: Due to the fact that the wood used is natural, the finish may vary.

Thickness and type of table top edge:

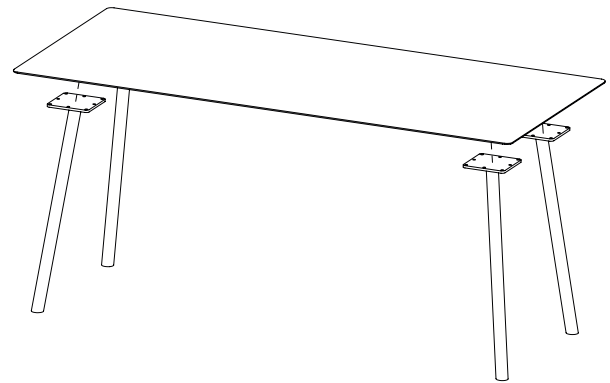
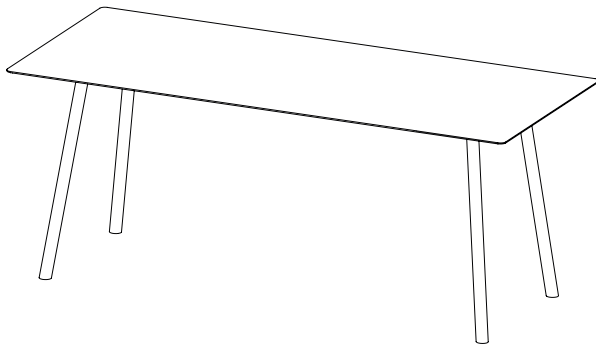

Different measures available for the height of the table:

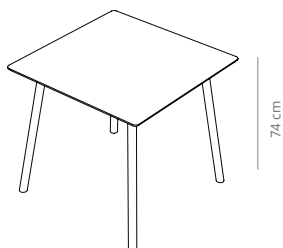
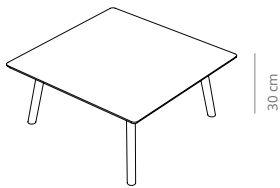

Types of legs:

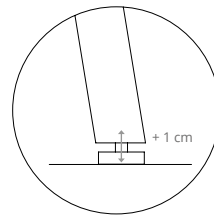

ADJUSTABLE HEIGHT LEGS

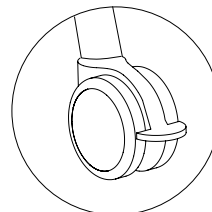

CASTERS WITH BRAKES*

*Only for table height 74 cm

Test certificates: UNE-EN 527-1:2011, UNE EN 527-2:03, UNE-EN 527-3:03 and ANSI BIFMA x5.5:2014 (table height 74).

TABLE 80X80

Height 30 cm

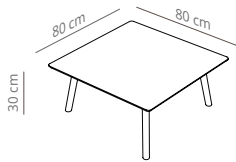

28.1 kg
 (x1) 96x96x7cm (0.06 m³)
 (x4) 16x16x33cm (0.01 m³)

Height 74 cm

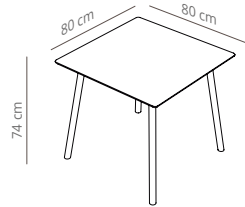

32.5 kg
 (x1) 96x96x7cm (0.06 m³)
 (x4) 16x16x81cm (0.02 m³)

CODE		FINISHES		PUBLIC PRICE			
HEIGHT 30	HEIGHT 74	LEGS	TOP	HEIGHT 30	HEIGHT 74		
VCBMAA880	MAAB80RO	white, black, taupe or combined	stained	matt oak	4.678 DKK	5.187 DKK	
				cognac, ash, bleached oak or walnut	5.034 DKK	5.560 DKK	
	MAAB80TX		lacquered	white or black	4.890 DKK	5.399 DKK	
				taupe, brick, ochre, olive green, dusty pink or dusty green	5.034 DKK	5.560 DKK	
	MAAB80HPLB		MAA80HPLB	HPL with MDF	white	5.882 DKK	6.526 DKK
	MAAB80HPLN		MAA80HPLN	HPL Soft Touch by Fenix with MDF	black	5.882 DKK	6.526 DKK
	MAAB80ROM		MAA80ROM	stained	matt oak	7.280 DKK	8.060 DKK
					cognac, ash, bleached oak or walnut	8.365 DKK	9.314 DKK
	MAAB80TXM		MAA80TXM	lacquered	white or black	8.060 DKK	8.899 DKK
					taupe, brick, ochre, olive green, dusty pink or dusty green	8.365 DKK	9.314 DKK
MAAB80HPLMB	MAA80HPLMB	HPL with MDF	white	8.814 DKK	9.772 DKK		
MAAB80HPLMN	MAA80HPLMN	HPL Soft Touch by Fenix with MDF	black	8.814 DKK	9.772 DKK		

Suggested maximum number of seats per table, calculated with an Aleta chair. The number of seats may vary depending on the chair model.

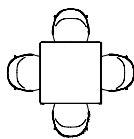

TABLES

Test certificates: UNE-EN 527-1:2011, UNE EN 527-2:03, UNE-EN 527-3:03 and ANSI BIFMA x5.5:2014 (table height 74).

TABLE 160X80

Height 30 cm

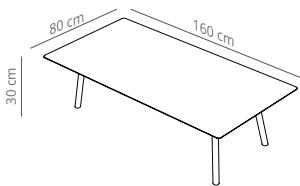

40.8 kg
 (x1) 180x94x8cm (0.14 m³)
 (x4) 16x16x33cm (0.01 m³)

Height 74 cm

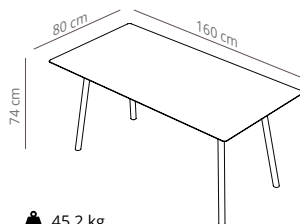

45.2 kg
 (x1) 180x94x8cm (0.14 m³)
 (x4) 16x16x81cm (0.02 m³)

CODE		FINISHES		PUBLIC PRICE			
HEIGHT 30	HEIGHT 74	LEGS	TOP	HEIGHT 30	HEIGHT 74		
VCBMAAB160	MAAB160RO	white, black, taupe or combined	stained	matt oak	5.509 DKK	6.068 DKK	
				cognac, ash, bleached oak or walnut	5.924 DKK	6.644 DKK	
	MAAB160TX		lacquered	white or black	5.653 DKK	6.331 DKK	
				taupe, brick, ochre, olive green, dusty pink or dusty green	5.924 DKK	6.644 DKK	
	MAAB160HPLB		MAA160HPLB	HPL with MDF	white	7.661 DKK	8.551 DKK
	MAAB160HPLN		MAA160HPLN	HPL Soft Touch by Fenix with MDF	black	7.661 DKK	8.551 DKK
	MAAB160ROM		MAA160ROM	stained	matt oak	8.534 DKK	9.492 DKK
					cognac, ash, bleached oak or walnut	9.916 DKK	10.975 DKK
	MAAB160TXM		MAA160TXM	lacquered	white or black	9.551 DKK	10.551 DKK
					taupe, brick, ochre, olive green, dusty pink or dusty green	9.916 DKK	10.975 DKK
MAAB160HPLMB	MAA160HPLMB	HPL with MDF	white	11.484 DKK	12.789 DKK		
MAAB160HPLMN	MAA160HPLMN	HPL Soft Touch by Fenix with MDF	black	11.484 DKK	12.789 DKK		

Suggested maximum number of seats per table, calculated with an Aleta chair. The number of seats may vary depending on the chair model.

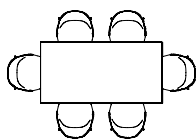

Test certificates: UNE-EN 527-1:2011, UNE EN 527-2:03, UNE-EN 527-3:03 and ANSI BIFMA x5.5:2014 (table height 74).

TABLE 160X90

Height 30 cm

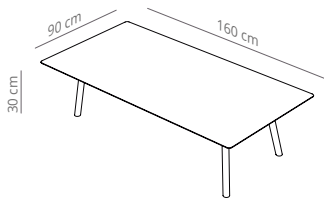

▲ 46.3 kg
 📦 (x1) 179x109x7cm (0.14 m³)
 📦 (x4) 16x16x33cm (0.01 m³)

Height 74 cm

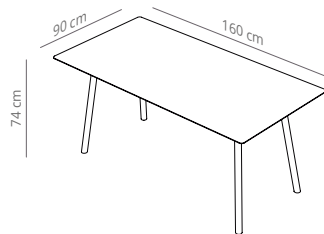

▲ 50.7 kg
 📦 (x1) 179x109x7cm (0.14 m³)
 📦 (x4) 16x16x81cm (0.02 m³)

CODE		FINISHES		PUBLIC PRICE			
HEIGHT 30	HEIGHT 74	LEGS	TOP	HEIGHT 30	HEIGHT 74		
VCBMAAB16090	MAAB160RO90	white, black, taupe or combined	stained	matt oak	6.136 DKK	6.848 DKK	
				cognac, ash, bleached oak or walnut	6.687 DKK	7.373 DKK	
	MAAB160TX90		MAA160TX90	lacquered	white or black	6.331 DKK	7.060 DKK
					taupe, brick, ochre, olive green, dusty pink or dusty green	6.687 DKK	7.373 DKK
	MAAB160HPL90B		MAA160HPL90B	HPL with MDF	white	8.551 DKK	9.492 DKK
	MAAB160HPL90N		MAA160HPL90N	HPL Soft Touch by Fenix with MDF	black	8.551 DKK	9.492 DKK
	MAAB160RO90M		MAA160RO90M	stained	matt oak	9.611 DKK	10.636 DKK
					cognac, ash, bleached oak or walnut	11.102 DKK	12.357 DKK
	MAAB160TX90M		MAA160TX90M	lacquered	white or black	10.636 DKK	11.882 DKK
					taupe, brick, ochre, olive green, dusty pink or dusty green	11.102 DKK	12.357 DKK
MAAB160HPL90MB	MAA160HPL90MB	HPL with MDF	white	12.789 DKK	14.213 DKK		
MAAB160HPL90MN	MAA160HPL90MN	HPL Soft Touch by Fenix with MDF	black	12.789 DKK	14.213 DKK		

Suggested maximum number of seats per table, calculated with an Aleta chair. The number of seats may vary depending on the chair model.

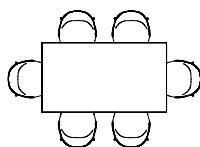

TABLES

Test certificates: UNE-EN 527-1:2011, UNE EN 527-2:03, UNE-EN 527-3:03 and ANSI BIFMA x5.5:2014 (table height 74).

TABLE 180X80

Height 30 cm

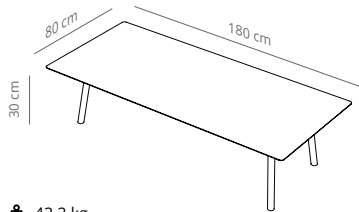

- 42.2 kg
- (x1) 200x94x8cm (0.15 m³)
- (x4) 16x16x33cm (0.01 m³)

Height 74 cm

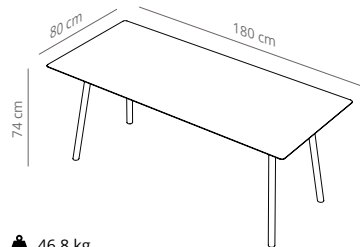

- 46.8 kg
- (x1) 200x94x8cm (0.15 m³)
- (x4) 16x16x81cm (0.02 m³)

CODE		FINISHES				PUBLIC PRICE		
HEIGHT 30		HEIGHT 74		LEGS	TOP	HEIGHT 30	HEIGHT 74	
VCBMAAB180	MAAB180RO	VCBMAA180	MAA180RO	white, black, taupe or combined	stained	matt oak	5.856 DKK	6.483 DKK
						cognac, ash, bleached oak or walnut	6.483 DKK	7.170 DKK
	MAAB180TX		MAA180TX		lacquered	white or black	6.068 DKK	6.797 DKK
						taupe, brick, ochre, olive green, dusty pink or dusty green	6.483 DKK	7.170 DKK
	MAAB180HPLB		MAA180HPLB	HPL with MDF	white	8.695 DKK	9.636 DKK	
	MAAB180HPLN		MAA180HPLN	HPL Soft Touch by Fenix with MDF	black	8.695 DKK	9.636 DKK	
	MAAB180ROM		MAA180ROM	matt oak, cognac, ash, bleached oak or walnut	stained	matt oak	9.119 DKK	10.212 DKK
							cognac, ash, bleached oak or walnut	10.746 DKK
					lacquered	white or black	10.323 DKK	9.789 DKK
						taupe, brick, ochre, olive green, dusty pink or dusty green	10.746 DKK	10.212 DKK
MAAB180HPLMB		MAA180HPLMB			HPL with MDF	white	12.950 DKK	14.374 DKK
MAAB180HPLMN		MAA180HPLMN			HPL Soft Touch by Fenix with MDF	black	12.950 DKK	14.374 DKK

Suggested maximum number of seats per table, calculated with an Aleta chair. The number of seats may vary depending on the chair model.

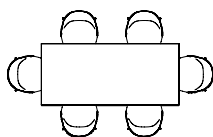

Test certificates: UNE-EN 527-1:2011, UNE EN 527-2:03, UNE-EN 527-3:03 and ANSI BIFMA x5.5:2014 (table height 74).

TABLE 180X90

Height 30 cm

Height 74 cm

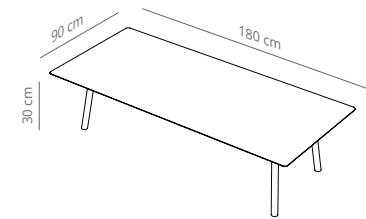

44.2 kg
 (x1) 201x110x7cm (0.15 m³)
 (x4) 16x16x33cm (0.01 m³)

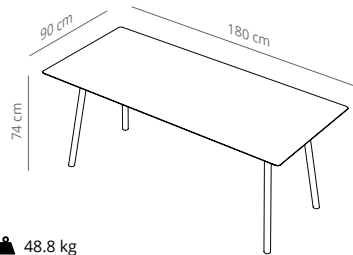

48.8 kg
 (x1) 201x110x7cm (0.15 m³)
 (x4) 16x16x81cm (0.02 m³)

CODE		FINISHES		PUBLIC PRICE				
HEIGHT 30	HEIGHT 74	LEGS	TOP	HEIGHT 30	HEIGHT 74			
VCBMAAB18090	MAAB180RO90	white, black, taupe or combined	stained	matt oak	6.644 DKK	7.314 DKK		
				cognac, ash, bleached oak or walnut	7.212 DKK	8.043 DKK		
	MAAB180TX90		MAA180TX90	lacquered	white or black	6.848 DKK	7.577 DKK	
					taupe, brick, ochre, olive green, dusty pink or dusty green	7.212 DKK	8.043 DKK	
	MAAB180HPL90B		MAA180HPL90B	HPL with MDF	white	8.941 DKK	9.984 DKK	
	MAAB180HPL90N		MAA180HPL90N	HPL Soft Touch by Fenix with MDF	black	8.941 DKK	9.984 DKK	
	MAAB180RO90M		MAA180RO90M	stained	matt oak	10.263 DKK	11.407 DKK	
					cognac, ash, bleached oak or walnut	12.068 DKK	13.424 DKK	
	MAAB180TX90M		MAA180TX90M	matt oak, cognac, ash, bleached oak or walnut	lacquered	white or black	11.585 DKK	12.840 DKK
						taupe, brick, ochre, olive green, dusty pink or dusty green	12.068 DKK	13.424 DKK
MAAB180HPL90MB	MAA180HPL90MB	HPL with MDF	white	13.407 DKK	14.950 DKK			
MAAB180HPL90MN	MAA180HPL90MN	HPL Soft Touch by Fenix with MDF	black	13.407 DKK	14.950 DKK			

Suggested maximum number of seats per table, calculated with an Aleta chair. The number of seats may vary depending on the chair model.

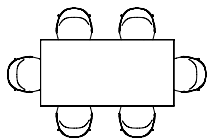

TABLES

Test certificates: UNE-EN 527-1:2011, UNE EN 527-2:03, UNE-EN 527-3:03 and ANSI BIFMA x5.5:2014 (table height 74).

TABLE 200X80

Height 30 cm

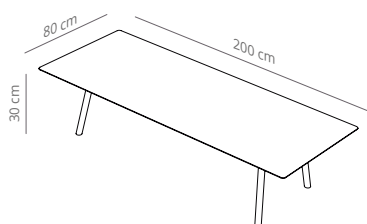

43.2 kg
 (x1) 220x94x8cm (0.15 m³)
 (x4) 16x16x33cm (0.01 m³)

Height 74 cm

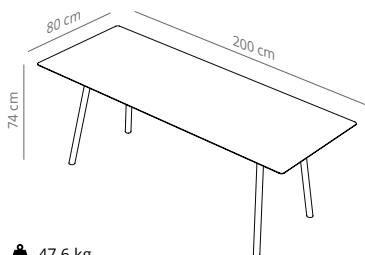

47.6 kg
 (x1) 220x94x8cm (0.15 m³)
 (x4) 16x16x81cm (0.02 m³)

CODE		FINISHES				PUBLIC PRICE			
HEIGHT 30		HEIGHT 74		LEGS	TOP	HEIGHT 30	HEIGHT 74		
VCBMAAB200	MAAB200RO	VCBMAA200	MAA200RO	white, black, taupe or combined	stained	matt oak	5.924 DKK	6.644 DKK	
						cognac, ash, bleached oak or walnut	6.958 DKK	7.678 DKK	
	MAAB200TX		MAA200TX	white, black, taupe or combined	lacquered	white or black	6.543 DKK	7.272 DKK	
						taupe, brick, ochre, olive green, dusty pink or dusty green	6.958 DKK	7.678 DKK	
	MAAB200HPLB		MAA200HPLB	white, black, taupe or combined	HPL with MDF	white	9.738 DKK	10.831 DKK	
	MAAB200HPLN		MAA200HPLN		HPL Soft Touch by Fenix with MDF	black	9.738 DKK	10.831 DKK	
	MAAB200ROM		MAA200ROM	matt oak, cognac, ash, bleached oak or walnut	stained	matt oak	9.246 DKK	10.263 DKK	
						cognac, ash, bleached oak or walnut	11.585 DKK	12.840 DKK	
	MAAB200TXM		MAA200TXM		matt oak, cognac, ash, bleached oak or walnut	lacquered	white or black	11.102 DKK	12.357 DKK
								taupe, brick, ochre, olive green, dusty pink or dusty green	11.585 DKK
MAAB200HPLMB	MAA200HPLMB	matt oak, cognac, ash, bleached oak or walnut	HPL with MDF	white	14.552 DKK	16.153 DKK			
MAAB200HPLMN	MAA200HPLMN		HPL Soft Touch by Fenix with MDF	black	14.552 DKK	16.153 DKK			

Suggested maximum number of seats per table, calculated with an Aleta chair. The number of seats may vary depending on the chair model.

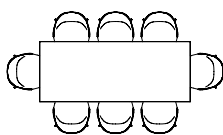

Test certificates: UNE-EN 527-1:2011, UNE EN 527-2:03, UNE-EN 527-3:03 and ANSI BIFMA x5.5:2014 (table height 74).

TABLE 200X90

Height 30 cm

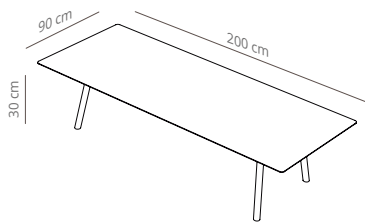

54.1 kg
 (x1) 219x107x9cm (0.21 m³)
 (x4) 16x16x33cm (0.01 m³)

Height 74 cm

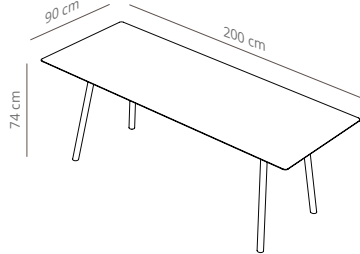

58.5 kg
 (x1) 219x107x9cm (0.21 m³)
 (x4) 16x16x81cm (0.02 m³)

CODE		FINISHES		PUBLIC PRICE			
HEIGHT 30	HEIGHT 74	LEGS	TOP	HEIGHT 30	HEIGHT 74		
VCBMAAB20090	MAAB200RO90	white, black, taupe or combined	stained	matt oak	6.687 DKK	7.373 DKK	
				cognac, ash, bleached oak or walnut	7.738 DKK	8.670 DKK	
	MAAB200TX90		MAA200TX90	lacquered	white or black	7.314 DKK	8.144 DKK
					taupe, brick, ochre, olive green, dusty pink or dusty green	7.738 DKK	8.670 DKK
	MAAB200HPL90B		MAA200HPL90B	HPL with MDF	white	10.229 DKK	11.365 DKK
	MAAB200HPL90N		MAA200HPL90N	HPL Soft Touch by Fenix with MDF	black	10.229 DKK	11.365 DKK
	MAAB200RO90M		MAA200RO90M	stained	matt oak	10.323 DKK	11.518 DKK
					cognac, ash, bleached oak or walnut	12.941 DKK	14.374 DKK
	MAAB200TX90M		MAA200TX90M	lacquered	white or black	12.475 DKK	13.840 DKK
					taupe, brick, ochre, olive green, dusty pink or dusty green	12.941 DKK	14.374 DKK
MAAB200HPL90MB	MAA200HPL90MB	HPL with MDF	white	15.348 DKK	17.060 DKK		
MAAB200HPL90MN	MAA200HPL90MN	HPL Soft Touch by Fenix with MDF	black	15.348 DKK	17.060 DKK		

Suggested maximum number of seats per table, calculated with an Aleta chair. The number of seats may vary depending on the chair model.

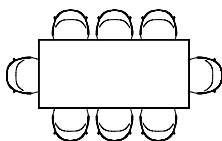

TABLES

TABLE 120

Height 30 cm:

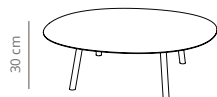

Height 74 cm:

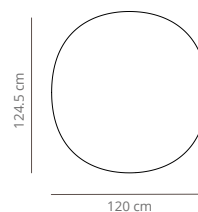
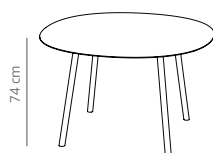

41.8 kg
 (x1) 136x143x8cm (0.16 m³)
 (x4) 16x16x33cm (0.01 m³)

46.2 kg
 (x1) 136x143x8cm (0.16 m³)
 (x4) 16x16x81cm (0.02 m³)

CODE		FINISHES				PUBLIC PRICE	
HEIGHT 30	HEIGHT 74	LEGS	TOP		HEIGHT 30	HEIGHT 74	
VCBMAABD120	MAABD120RO	MAAD120RO	white, black, taupe or combined	stained	matt oak	6.543 DKK	7.212 DKK
					cognac, ash, bleached oak or walnut	7.060 DKK	7.831 DKK
	MAABD120TX	MAAD120TX		lacquered	white or black	6.687 DKK	7.373 DKK
					taupe, brick, ochre, olive green, dusty pink or dusty green	7.060 DKK	7.831 DKK
	MAABD120HPLB	MAAD120HPLB	matt oak, cognac, ash, bleached oak or walnut	HPL with MDF	white	8.602 DKK	9.594 DKK
	MAABD120HPLN	MAAD120HPLN		HPL Soft Touch by Fenix with MDF	black	8.602 DKK	9.594 DKK
	MAABD120ROM	MAAD120ROM		stained	matt oak	8.831 DKK	9.789 DKK
					cognac, ash, bleached oak or walnut	10.263 DKK	11.458 DKK
	MAABD120TXM	MAAD120TXM		lacquered	white or black	9.916 DKK	10.975 DKK
					taupe, brick, ochre, olive green, dusty pink or dusty green	10.263 DKK	11.458 DKK
MAABD120HPLMB	MAAD120HPLMB	HPL with MDF	white	12.907 DKK	14.331 DKK		
MAABD120HPLMN	MAAD120HPLMN	HPL Soft Touch by Fenix with MDF	black	12.907 DKK	14.331 DKK		

The table top shape is slightly oval

Suggested maximum number of seats per table, calculated with an Aleta chair. The number of seats may vary depending on the chair model.

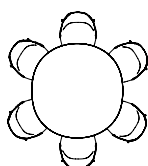

Maarten

2014, BY VICTOR CARRASCO

TABLES

Test certificates: UNE-EN 527-1:2011, UNE EN 527-2:03, UNE-EN 527-3:03 and ANSI BIFMA x5.5:2014 (table height 74).

TABLE 160

Height 30 cm:



Height 74 cm:

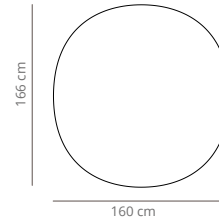

61.8 kg
 (x1) 186x176x8cm (0.26 m³)
 (x4) 16x16x33cm (0.01 m³)

66.2 kg
 (x1) 186x176x8cm (0.26 m³)
 (x4) 16x16x81cm (0.02 m³)

CODE		FINISHES			PUBLIC PRICE		
HEIGHT 30	HEIGHT 74	LEGS	TOP		HEIGHT 30	HEIGHT 74	
VCBMAABD160	MAABD160RO	MAAD160RO	white, black, taupe or combined	stained	matt oak	8.619 DKK	9.543 DKK
	MAABD160TX				MAAD160TX	cognac, ash, bleached oak or walnut	9.348 DKK
		MAABD160ROM		MAAD160ROM		stained	white or black
	MAABD160TXM				MAAD160TXM		lacquered
MAABD160ROM		MAAD160ROM	stained	matt oak		11.695 DKK	
	MAABD160TXM			MAAD160TXM	lacquered	cognac, ash, bleached oak or walnut	13.730 DKK
MAABD160TXM		MAAD160TXM	lacquered			white or black	13.128 DKK
	MAABD160TXM			MAAD160TXM	lacquered	taupe, brick, ochre, olive green, dusty pink or dusty green	13.730 DKK

The table top shape is slightly oval

Suggested maximum number of seats per table, calculated with an Aleta chair. The number of seats may vary depending on the chair model.

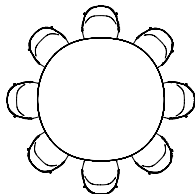

TABLES

RETURN TABLE 180X80

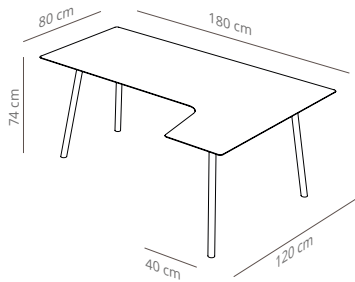

IMPORTANT: please indicate with a drawing, the situation of each table, especially when combined with the support container or added accessories, along with the order to avoid confusion. Always remember that the right or left denomination always means facing the element. The more information you attach to the order, the less chance of error.

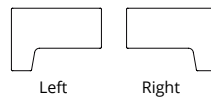

- 44.2 kg
- (x1) 200x145x8cm (0.22 m³)
- (x4) 16x16x81cm (0.02 m³)

CODE		FINISHES		PUBLIC PRICE	
HEIGHT 74		LEGS	TOP	HEIGHT 74	
VCBMAAA180	MAAA180RO	white, black, taupe or combined	stained	matt oak	8.509 DKK
				cognac, ash, bleached oak or walnut	9.289 DKK
	MAAA180TX		lacquered	white or black	8.772 DKK
				taupe, brick, ochre, olive green, dusty pink or dusty green	9.289 DKK
	MAAA180HPLB		HPL with MDF	white	13.051 DKK
	MAAA180HPLN		HPL Soft Touch by Fenix with MDF	black	13.051 DKK
	MAAA180ROM		stained	matt oak	11.416 DKK
				cognac, ash, bleached oak or walnut	13.543 DKK
	MAAA180TXM		lacquered	white or black	12.975 DKK
				taupe, brick, ochre, olive green, dusty pink or dusty green	13.543 DKK
MAAA180HPLMB	HPL with MDF	white	16.950 DKK		
MAAA180HPLMN	HPL Soft Touch by Fenix with MDF	black	16.950 DKK		

Note: the manufacturing lead time for the table is 2 weeks longer than the normal manufacturing lead time.

Suggested maximum number of seats per table, calculated with an Aleta chair. The number of seats may vary depending on the chair model.

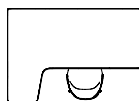

TABLES WITH CASTERS

Test certificates: UNE-EN 15372:2017

Table 80x80 with casters

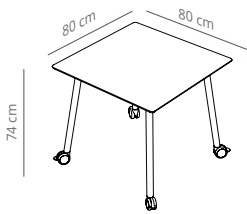

- 28.1 kg
- (x1) 96x96x7cm (0.06 m³)
- (x4) 16x16x80cm (0.02 m³)

CODE		FINISHES		PUBLIC PRICE	
		LEGS	TOP		
VCBMAA80R	MAA80ROR	white, black, taupe or combined	stained	matt oak	5.814 DKK
				cognac, ash, bleached oak or walnut	6.178 DKK
	MAA80TXR		lacquered	white or black	6.026 DKK
				taupe, brick, ochre, olive green, dusty pink or dusty green	6.178 DKK
MAA80HPLRB	HPL with MDF	white	6.966 DKK		
MAA80HPLRN	HPL Soft Touch by Fenix with MDF	black	6.966 DKK		

Suggested maximum number of seats per table, calculated with an Aleta chair. The number of seats may vary depending on the chair model.

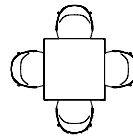

Test certificates: UNE-EN 527-1:2011, UNE EN 527-2:2017 A1:2019

Table 160x80 with casters

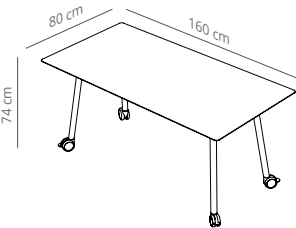

- 40.8 kg
- (x1) 180x94x8cm (0.14 m³)
- (x4) 16x16x36cm (0.01 m³)

CODE		FINISHES		PUBLIC PRICE	
		LEGS	TOP		
VCBMAA160R	MAA160ROR	white, black, taupe or combined	stained	matt oak	6.755 DKK
				cognac, ash, bleached oak or walnut	7.272 DKK
	MAA160TXR		lacquered	white or black	6.958 DKK
				taupe, brick, ochre, olive green, dusty pink or dusty green	7.272 DKK
MAA160HPLRB	HPL with MDF	white	8.941 DKK		
MAA160HPLRN	HPL Soft Touch by Fenix with MDF	black	8.941 DKK		

Suggested maximum number of seats per table, calculated with an Aleta chair. The number of seats may vary depending on the chair model.

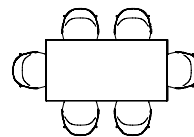

TABLES

Test certificates: UNE-EN 527-1:2011, UNE EN 527-2:2017 A1:2019

Table 160x90 with casters

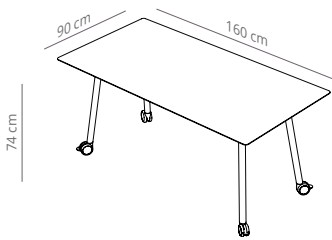

- 46.3 kg
- (x1) 179x109x7cm (0.14 m³)
- (x4) 16x16x80cm (0.02 m³)

CODE		FINISHES		PUBLIC PRICE	
		LEGS	TOP		
VCBMAA16090R	MAA160RO90R	white, black, taupe or combined	stained	matt oak	7.466 DKK
				cognac, ash, bleached oak or walnut	8.043 DKK
	MAA160TX90R		lacquered	white or black	7.678 DKK
				taupe, brick, ochre, olive green, dusty pink or dusty green	8.043 DKK
	MAA160HPL90RB	HPL with MDF	white	9.882 DKK	
	MAA160HPL90RN	HPL Soft Touch by Fenix with MDF	black	9.882 DKK	

Suggested maximum number of seats per table, calculated with an Aleta chair. The number of seats may vary depending on the chair model.

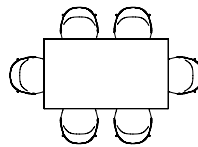

Test certificates: UNE-EN 527-1:2011, UNE EN 527-2:2017 A1:2019

Table 180x80 with casters

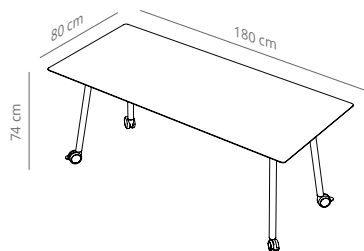

- 44.2 kg
- (x1) 200x94x8cm (0.15 m³)
- (x4) 16x16x80cm (0.02 m³)

CODE		FINISHES		PUBLIC PRICE	
		LEGS	TOP		
VCBMAA180R	MAA180ROR	white, black, taupe or combined	stained	matt oak	7.111 DKK
				cognac, ash, bleached oak or walnut	7.789 DKK
	MAA180TXR		lacquered	white or black	7.424 DKK
				taupe, brick, ochre, olive green, dusty pink or dusty green	7.789 DKK
	MAA180HPLRB	HPL with MDF	white	10.085 DKK	
	MAA180HPLRN	HPL Soft Touch by Fenix with MDF	black	10.085 DKK	

Suggested maximum number of seats per table, calculated with an Aleta chair. The number of seats may vary depending on the chair model.

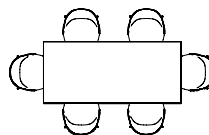

Test certificates: UNE-EN 527-1:2011, UNE EN 527-2:2017 A1:2019

Table 180x90 with casters

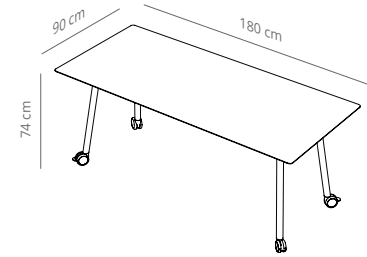

- 48.8 kg
- (x1) 201x110x7cm (0.15 m³)
- (x4) 16x16x80cm (0.02 m³)

CODE		FINISHES		PUBLIC PRICE	
		LEGS	TOP		
VCBMAA18090R	MAA180RO90R	white, black, taupe or combined	stained	matt oak	7.933 DKK
				cognac, ash, bleached oak or walnut	8.670 DKK
	MAA180TX90R		lacquered	white or black	8.255 DKK
				taupe, brick, ochre, olive green, dusty pink or dusty green	8.670 DKK
	MAA180HPL90RB	HPL with MDF	white	10.382 DKK	
	MAA180HPL90RN	HPL Soft Touch by Fenix with MDF	black	10.382 DKK	

Suggested maximum number of seats per table, calculated with an Aleta chair. The number of seats may vary depending on the chair model.

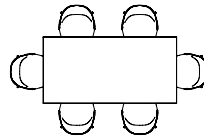
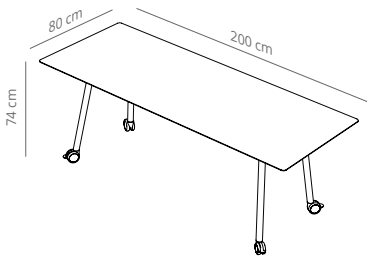

Table 200x80 with casters



- 47.4 kg
- (x1) 220x94x8cm (0.15 m³)
- (x4) 16x16x80cm (0.02 m³)

CODE		FINISHES		PUBLIC PRICE	
		LEGS	TOP		
VCBMAA200R	MAA200ROR	white, black, taupe or combined	stained	matt oak	7.272 DKK
				cognac, ash, bleached oak or walnut	8.356 DKK
	MAA200TXR		lacquered	white or black	7.890 DKK
				taupe, brick, ochre, olive green, dusty pink or dusty green	8.356 DKK
	MAA200HPLRB	HPL with MDF	white	11.263 DKK	
	MAA200HPLRN	HPL Soft Touch by Fenix with MDF	black	11.263 DKK	

Suggested maximum number of seats per table, calculated with an Aleta chair. The number of seats may vary depending on the chair model.

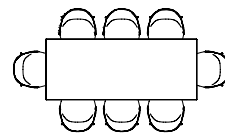

TABLES

Test certificates: UNE-EN 527-1:2011, UNE EN 527-2:2017 A1:2019

Table 200x90 with casters

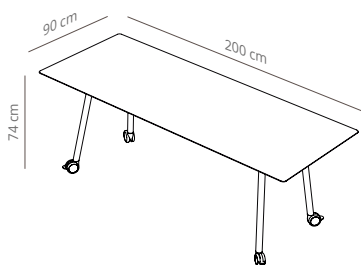

54.1 kg
 (x1) 219x107x9cm (0.21 m³)
 (x4) 16x16x80cm (0.02 m³)

CODE		FINISHES		PUBLIC PRICE	
		LEGS	TOP		
VCBMAA20090R	MAA200RO90R	white, black, taupe or combined	stained	matt oak	8.043 DKK
				cognac, ash, bleached oak or walnut	9.289 DKK
	MAA200TX90R		lacquered	white or black	8.772 DKK
				taupe, brick, ochre, olive green, dusty pink or dusty green	9.289 DKK
MAA200HPL90RB	HPL with MDF	white	11.814 DKK		
MAA200HPL90RN	HPL Soft Touch by Fenix with MDF	black	11.814 DKK		

Suggested maximum number of seats per table, calculated with an Aleta chair. The number of seats may vary depending on the chair model.

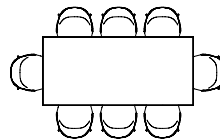

Test certificates: ANSI/BIFMA X5.5:2014

Table 120 with casters

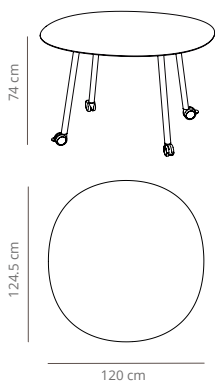

41.8kg
 (x1) 136x143x8cm (0.16 m³)
 (x4) 16x16x80cm (0.02 m³)

CODE		FINISHES		PUBLIC PRICE	
		LEGS	TOP		
VCBMAA120R	MAAD120ROR	white, black, taupe or combined	stained	matt oak	7.831 DKK
				cognac, ash, bleached oak or walnut	8.509 DKK
	MAAD120TXR		lacquered	white or black	8.043 DKK
				taupe, brick, ochre, olive green, dusty pink or dusty green	8.509 DKK
MAAD120HPLRB	HPL with MDF	white	9.984 DKK		
MAAD120HPLRN	HPL Soft Touch by Fenix with MDF	black	9.984 DKK		

The table top shape is slightly oval

Suggested maximum number of seats per table, calculated with an Aleta chair. The number of seats may vary depending on the chair model.

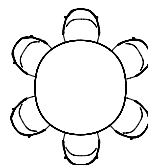

Test certificates: ANSI/BIFMA X5.5:2014

Table 160

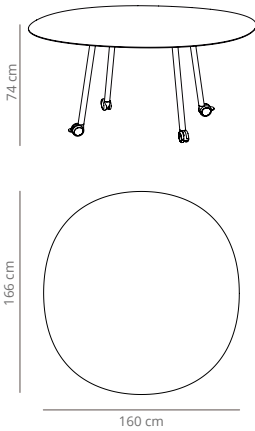

- 61.8 kg
- (x1) 186x176x8cm (0.26 m³)
- (x4) 16x16x80cm (0.02 m³)

CODE		FINISHES		PUBLIC PRICE	
		LEGS	TOP		
VCBMAA160R	MAAD160ROR	white, black, taupe or combined	stained	matt oak	10.221 DKK
				cognac, ash, bleached oak or walnut	11.051 DKK
	MAAD160TXR		lacquered	white or black	10.492 DKK
				taupe, brick, ochre, olive green, dusty pink or dusty green	11.051 DKK

The table top shape is slightly oval

Suggested maximum number of seats per table, calculated with an Aleta chair. The number of seats may vary depending on the chair model.

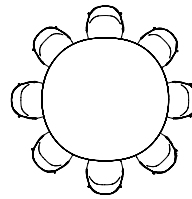

Return table 180x80 with casters

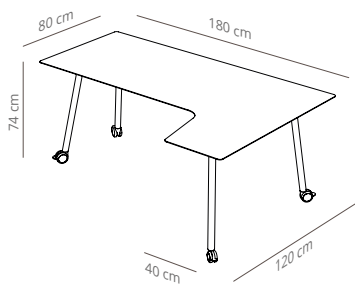

- 38.8 kg
- (x1) 200x145x8cm (0.22 m³)
- (x4) 16x16x84cm (0.02 m³)

CODE		FINISHES		PUBLIC PRICE	
		LEGS	TOP		
VCBMAAA180R	MAAA180ROR	white, black, taupe or combined	stained	matt oak	9.136 DKK
				cognac, ash, bleached oak or walnut	9.967 DKK
	MAAA180TXR		lacquered	white or black	9.390 DKK
				taupe, brick, ochre, olive green, dusty pink or dusty green	9.967 DKK
	MAAA180HPLRB		HPL with MDF	white	13.450 DKK
	MAAA180HPLRN		HPL Soft Touch by Fenix with MDF	black	13.450 DKK

Note: the manufacturing lead time for the table is 2 weeks longer than the normal manufacturing lead time.

Suggested maximum number of seats per table, calculated with an Aleta chair. The number of seats may vary depending on the chair model.

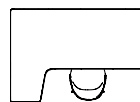

IMPORTANT: please indicate with a drawing, the situation of each table, especially when combined with the support container or added accessories, along with the order to avoid confusion. Always remember that the right or left denomination always means facing the element. The more information you attach to the order, the less chance of error.

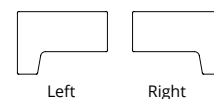

WIRE MANAGEMENT

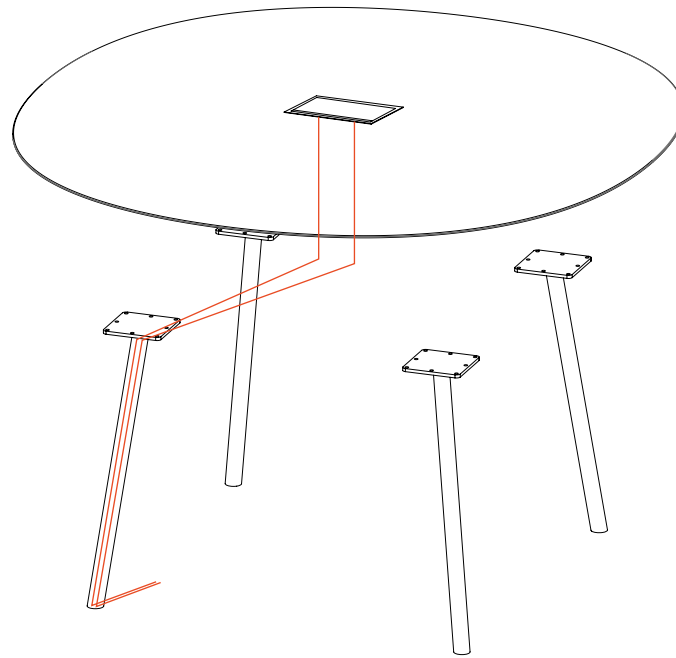

Wire management leg

CODE		FINISHES		PUBLIC PRICE
-	MAAPMER	lacquered	white, black or taupe	822 DKK

The Maarten table allows the possibility to manage the wiring so that it is hidden and integrated into the table. For this purpose, the cable management leg (MAAPMER) is available as an option.

The leg allows up to 4 cables to be routed inside the table down to the floor.



Wire management metal leg.

ACCESSORIES

For the different table tops, we offer the possibility of installing the following accessories. The drawings with the location of the accessories require the approval of the technical department.

Wire hole

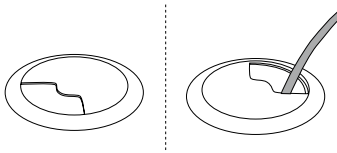

Installed and included in the board box.

CODE	FINISHES	PUBLIC PRICE
-	AC03B black or white	153 DKK

Cut out of the board is included
Dimensions: Ø 6 cm

Cut out

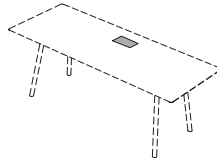

CODE	PUBLIC PRICE
-	MAARMEC 1.093 DKK

Table top with incision to measure.
The price is indicated per table top.

Table top protector in ecoleather

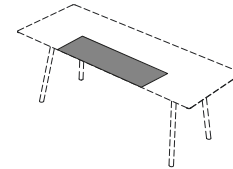

1 kg
 Installed and included in the table top box

CODE	FINISHES	PUBLIC PRICE
-	PROT ecoleather	2.187 DKK

Dimensions: 44x90 cm

Wire holder

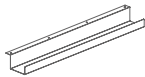

2.5 kg
 (x1) 19x9x122.5cm (0.02 m³)

CODE	FINISHES	PUBLIC PRICE
-	LECAN black or white	670 DKK

Dimensions: 99x16x9 cm

Simple wire column

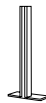

3 kg
 (x1) 74x15x28cm (0.03 m³)

CODE	FINISHES	PUBLIC PRICE
-	LEWIRES black or white	1.500 DKK

Dimensions: 25x12x71 cm

Double wire column

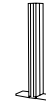

3 kg
 (x1) 74x15x28cm (0.03 m³)

CODE	FINISHES	PUBLIC PRICE
-	LEWIRED black or white	2.856 DKK

Dimensions: 25x12x71 cm

Modesty screen 160

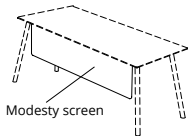

(x1) 134x53x9cm (0.06 m³)

CODE	FINISHES	PUBLIC PRICE
VCBMAAF160	MAAF160RO matt oak, cognac, ash, bleached oak or walnut	1.398 DKK
	MAAF160TX black or white	1.458 DKK
	MAAF160TX taupe, brick, ochre, olive green, dusty pink or dusty green	1.500 DKK

Dimensions: 114x33 cm

Modesty screen 180 and 200

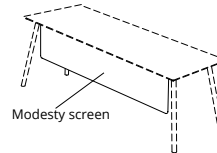

(x1) 154x53x9cm (0.07 m³)

CODE	FINISHES	PUBLIC PRICE
VCBMAAF180	MAAF180RO MAAF200RO matt oak, cognac, ash, bleached oak or walnut	1.398 DKK
	MAAF180TX MAAF200TX black or white	1.458 DKK
	MAAF180TX MAAF200TX taupe, brick, ochre, olive green, dusty pink or dusty green	1.500 DKK

Dimensions: 134x33 cm

TABLES

POWER OPTIONS

Table top hatch



1.2 kg
 (x1) 34x18x9cm (0.005 m³)

CODE		FINISHES	PUBLIC PRICE
VCBCAP*	CAP*	black or white	1.246 DKK

Metallic access hatch to the lower part of the table.

Available in white, black or grey. Does not include power options.

Dimensions: 32x15 cm

* Cut out not included.

Table top hatch plus

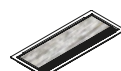

1.2 kg
 (x1) 34x18x9cm (0.005 m³)

CODE		FINISHES	PUBLIC PRICE
VCBCAPP*	CAPP*	black or grey	1.500 DKK

Metallic access hatch to the lower part of the table, for wooden table tops. Metal

frame available in black or grey and central part in the veneer of the finish of the table. Does not include power options.

Dimensions: 32x15 cm

* Cut out not included.

USB hub

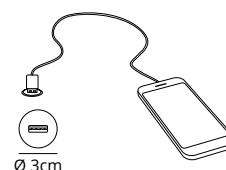

Installed and included in the table top box

CODE		FINISHES	PUBLIC PRICE
-	MAAUSB	black or white	525 DKK

Built-in USB hub for device charging.

Available in black or white.

Dimensions: Ø 3 cm

Table top powerbox



1.4 kg
 (x1) 33x17x7.5 cm (0.004 m³)

CODE		FINISHES	PUBLIC PRICE
-	BOX-E*	black or white	2.441 DKK
-	BOX-M*		3.534 DKK

BOX-E: 4 sockets

BOX-M: 4 devices (sockets and multimedia)

Metallic hatch with 4 sockets or combined with built-in multimedia devices.

Available in white, black or grey.

Dimensions: 32x15 cm

* Cut out not included.

For all available power options [see page 506](#)

Table top powerbox plus



1.4 kg
 (x1) 33x17x7.5 cm (0.004 m³)

CODE		FINISHES	PUBLIC PRICE
-	BOXP-E*	black or white	3.534 DKK
-	BOXP-M*		4.610 DKK

BOXP-E: 4 sockets

BOXP-M: 4 devices (sockets and multimedia)

Metallic hatch for wooden table tops with 4 sockets or combined with built-in multimedia devices. Metal frame available in black or grey and central part in the veneer of the finish of the table.

Dimensions: 32x15 cm

* Cut out not included.

For all available power options [see page 506](#)

Under table powerbox

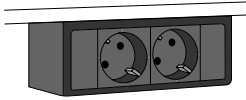

1.7 kg
 (x1) 17x18x9cm (0.005 m³)

CODE		FINISHES	PUBLIC PRICE
-	MAAEL-E	black	2.814 DKK

Powerbox available with 2 sockets or combined with built-in multimedia devices

For all available power options *see page 506*

USB hub with battery

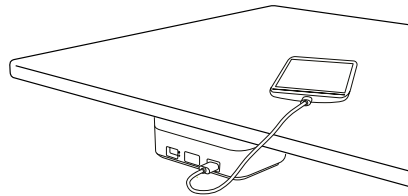

1.4 kg
 (x1) 40x20x25cm (0.02 m³)

CODE		FINISHES	PUBLIC PRICE
-	MAAEL-B	black	2.187 DKK

USB hub with two USB device charging ports without being plugged into electric current.

It's needed to buy the battery charging tray to charge the USB hub battery.

Battery charging tray

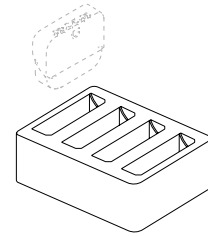

1 kg
 (x1) 40x20x25cm (0.02 m³)

CODE		FINISHES	PUBLIC PRICE
-	MAAEL-C	black	2.542 DKK

Battery charging tray. Charges up to four stations simultaneously in 7 hours. Includes magnetic key to remove the station from its support.

Each hatch has 4 modules (sockets or multimedia devices) to install power options. The modules can be complete (1) or half module. (1/2).

The power options are under the UNE-EN 50085 standards.

For the references BOX-E, BOX-M, BOXP-E, BOXP-M y MAAEL-E the cable length is 0.3 meters with Wieland connector. The power connection cable is not included, and will have to be provided by the customer.

TABLES

SEATINGS RECOMMENDED PER TABLE

Table 80x80 (up to 4 chairs)

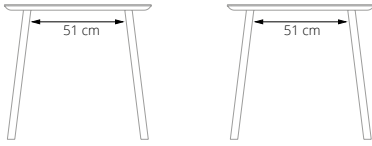

Table 160x80 | 160x90 (up to 6 chairs)



Table 180x80 | 180x90 (up to 8 chairs)

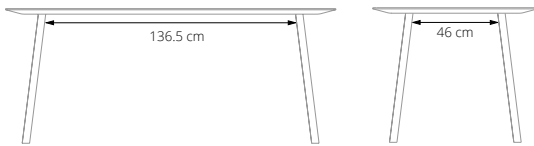
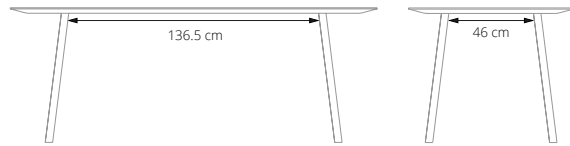

Table 200x80 | 200x90 (up to 8 chairs)



Return table 180x80



Table 120 (up to 6 chairs)

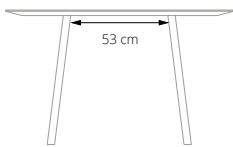
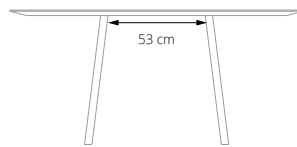

Table 160 (up to 8 chairs)



POWER POSITION SUGGESTIONS

We have curated a selection of cut out positions from the most demanded due to its polyvalence and flexibility.

Please contact our sales team in case you need a quote for specials, we are open to listen to your needs. For other options, please contact the sales team, indicating the cut out reference in the order.

All the cut outs presented have the measure of a standard power box (32x15cm), compatible with the references CAP, CAPP, BOX-E, BOX-M, BOXP-E and BOXP-M.

The circle represents the column centered option for cut out and power options, only compatible for references CAMEC, CATC and CAUSB.

TABLE 80x80

80 A

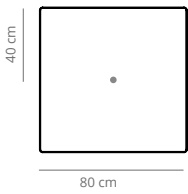

TABLES 160

160 A

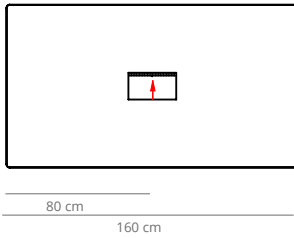

160 B

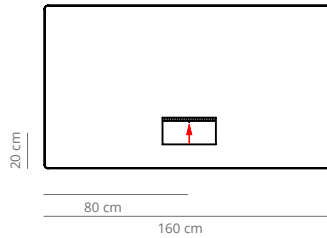

160 C

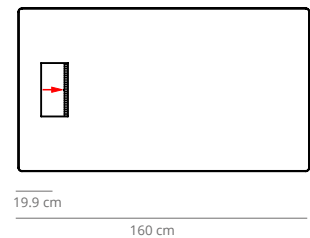

TABLES 180

180 A

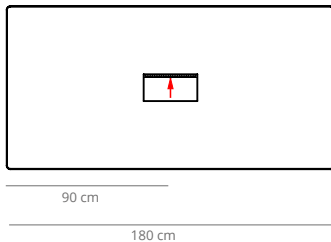

180 B

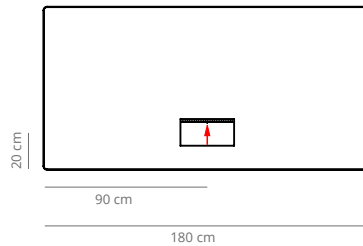

180 C

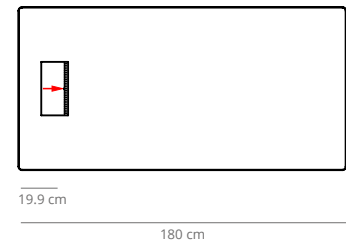

 The rectangle represents a standard powerbox (32x15 cm), compatible with references CAP, CAPP, BOX-E, BOX-M, BOXP-E y BOXP-M. The arrow points out the opening side.

- The circle represents the column centered option for cut out and power options, only compatible for references CAMEC, CATC and CAUSB.

TABLES

TABLES 200

200 B

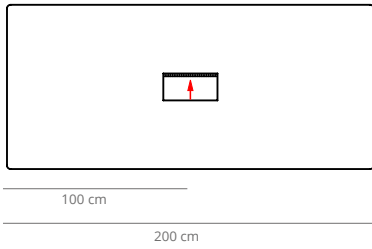

200 C

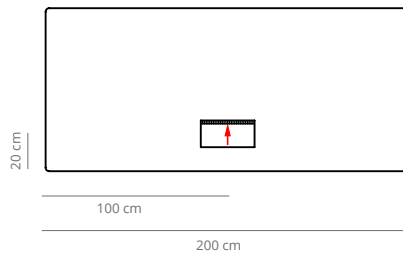

200 D

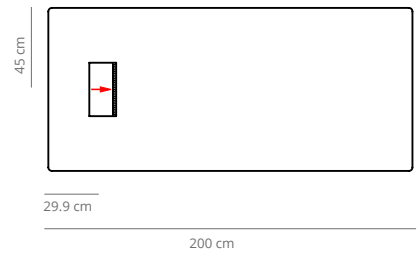

RIGHT WING TABLES

180 DA

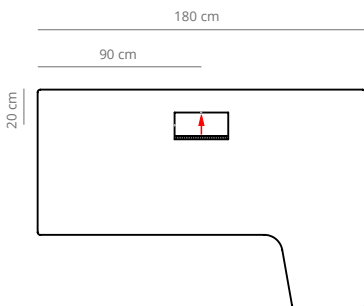

180 DB

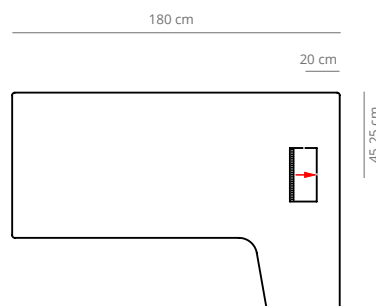

180 DC

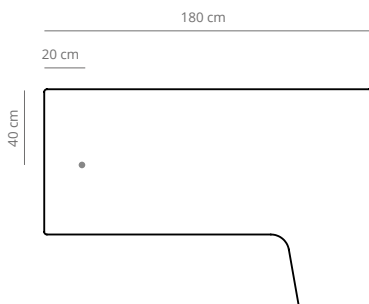

180 DD

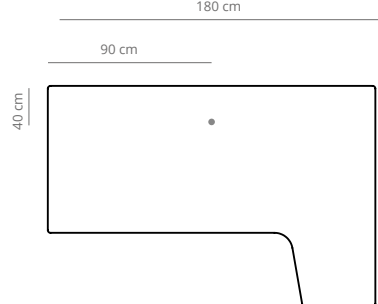

180 DE

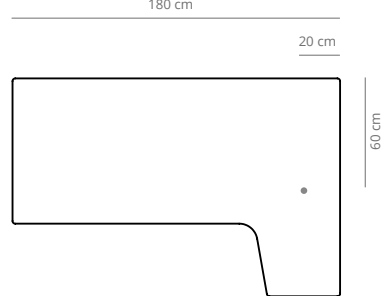

 The rectangle represents a standard powerbox (32x15 cm), compatible with references CAP, CAPP, BOX-E, BOX-M, BOXP-E y BOXP-M. The arrow points out the opening side.

- The circle represents the column centered option for cut out and power options, only compatible for references CAMEC, CATC and CAUSB.

LEFT WING TABLES

180 IA

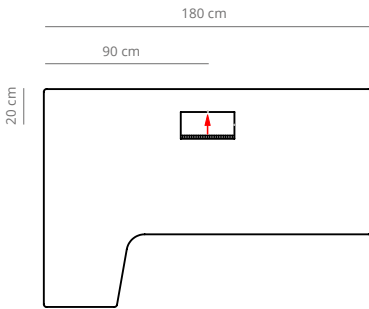

180 IB

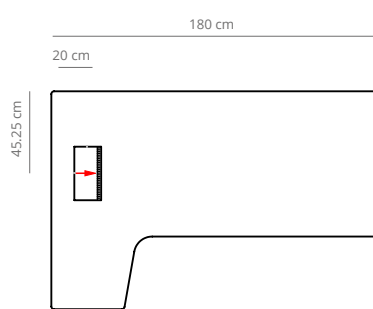

180 IC

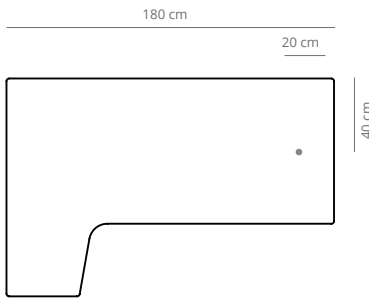

180 ID

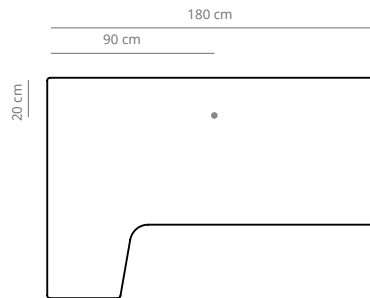

180 IE

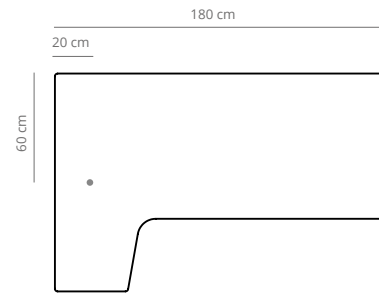

ROUND TABLES

120 OA

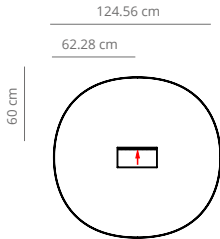

120 OB

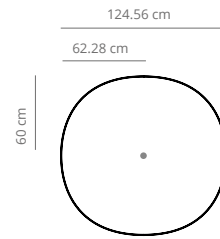

160 OA

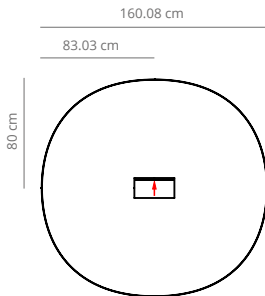

160 OB

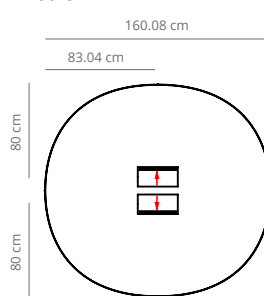

160 OC

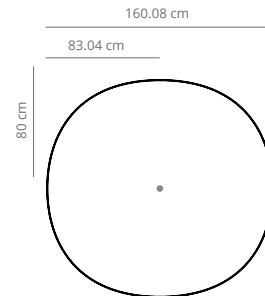

The rectangle represents a standard powerbox (32x15 cm), compatible with references CAP, CAPP, BOX-E, BOX-M, BOXP-E y BOXP-M. The arrow points out the opening side.

- The circle represents the column centered option for cut out and power options, only compatible for references CAMEC, CATC and CAUSB.



Burin

BY PATRICIA URQUIOLA

TABLES

Burin is a symbolic tribute to traditional wood carving tools. The unmistakable silhouette of the base runs through this extension of the collection to include a new table with a central base, available in different heights and a double version for large surface areas.

Conceived for both homes and community spaces, the new Burin table gives continuity to the family that was launched in 2011 with the side table designed by Patricia Urquiola.

NOTE: We can offer the possibility to ship the tables without counterweight. There is no option to install the tables without the recommended counterweight. For more detailed information please contact the Sales Department.

NOTE 2: For tables equal to, or longer than 240 cm, the production delay is two additional weeks respect the normal production term.

Central support available in roto-moulded polyethylene in white, black or taupe.

The 30 mm thick cover or work surface is made with microtextured MDF. It is lacquered with one of our collection's finishes, making it very scratch resistant. It also comes with a solid oak veneer, stained in mate, wenge, cognac or ash. Available in high resistance materials such as HPL with MDF for heavy contract use.

THICKNESSES AND TYPES OF BOARD EDGES:

More table top information on page 21

MDF laquered | HPL with MDF

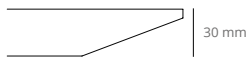

Melamine

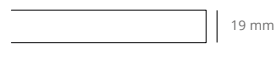

Compact

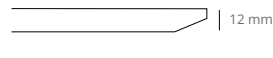

The total size of the compact and melamine tabletops may vary by ± 1cm

CENTRAL ELECTRIFICATION

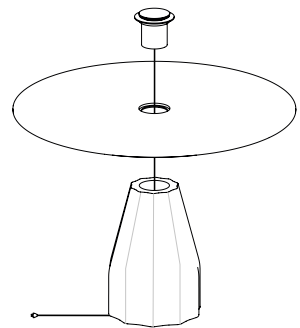

HEIGHTS AND BASES AVAILABLE

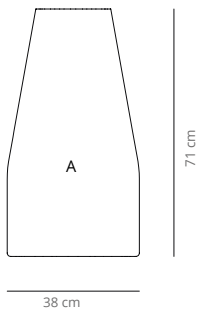

Table tops available for base A:
D60 - D100 | 70x70 - 80x80

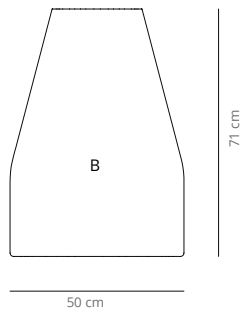

Table tops available for base B:
D120 | 90x90 - 100x100

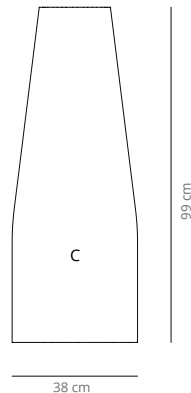

Table tops available for base C:
D60 - D100 | 70x70 - 80x80

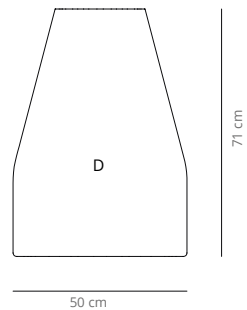
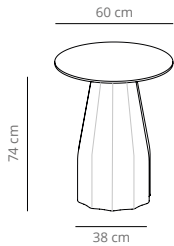

Table tops available for base D:
D150 | 240x120 - 300x150 - 500x150

HEIGHT 74

Test certificates: UNE-EN 15372:2017, UNE-EN 527-1:2011, UNE EN 527-2:2017 A1:2019

Table diameter 60



57.2 kg
 (x1) 59x55x89 cm (0.29 m³)
 (x1) 76x76x7 cm (0.04 m³)

CODE		BASE	FINISHES		PUBLIC PRICE
			TOP		
VCBBUD6075HM	BUD60M	white, black or taupe	melamine	white or black	3.458 DKK
VCBBUD6087	BUD60		stained	matt oak, cognac, ash, bleached oak or walnut	4.204 DKK
	BUD60TX		lacquered (microtexturized)	white or black	4.254 DKK
taupe, brick, ochre, olive green, dusty pink or dusty green				4.356 DKK	
VCBBUD6047	BUD60CN		compact laminate (black edge)	black	4.678 DKK
	BUD60CB		compact laminate (white edge)	white	4.678 DKK
VCBBUD6075HPL	BUD60HPLN		HPL Soft Touch by Fenix with MDF	black	4.449 DKK
	BUD60HPLB		HPL with MDF	white	4.449 DKK

Suggested maximum number of seats per table, calculated with an Aleta chair. The number of seats may vary depending on the chair model.

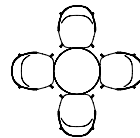
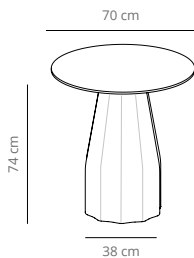

Table diameter 70



54.6 kg
 (x1) 59x55x89 cm (0.29 m³)
 (x1) 96x96x7 cm (0.06 m³)

CODE		BASE	FINISHES		PUBLIC PRICE
			TOP		
VCBBUD7075HM	BUD70M	white, black or taupe	melamine	white or black	3.559 DKK
VCBBUD7087	BUD70		stained	matt oak, cognac, ash, bleached oak or walnut	4.356 DKK
	BUD70TX		lacquered (microtexturized)	white or black	4.526 DKK
taupe, brick, ochre, olive green, dusty pink or dusty green				4.610 DKK	
VCBBUD7047	BUD70CN		compact laminate (black edge)	black	4.890 DKK
	BUD70CB		compact laminate (white edge)	white	4.890 DKK
VCBBUD7075HPL	BUD70HPLN		HPL Soft Touch by Fenix with MDF	black	4.653 DKK
	BUD70HPLB		HPL with MDF	white	4.653 DKK

Suggested maximum number of seats per table, calculated with an Aleta chair. The number of seats may vary depending on the chair model.

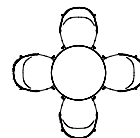

TABLES

Test certificates: UNE-EN 15372:2017, UNE-EN 527-1:2011, UNE EN 527-2:2017 A1:2019

Table diameter 80

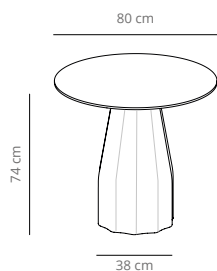

60.3 kg
 (x1) 59x55x89cm (0.29 m³)
 (x1) 96x96x7cm (0.06 m³)

CODE		BASE	FINISHES		PUBLIC PRICE
			TOP		
VCBBUD8075HM	BUD80M	white, black or taupe	melamine	white or black	4.153 DKK
VCBBUD8087	BUD80		stained	matt oak, cognac, ash, bleached oak or walnut	5.034 DKK
	BUD80TX		lacquered (microtexturized)	white or black	5.653 DKK
taupe, brick, ochre, olive green, dusty pink or dusty green				5.763 DKK	
VCBBUD8047	BUD80CN		compact laminate (black edge)	black	6.026 DKK
	BUD80CB		compact laminate (white edge)	white	6.026 DKK
VCBBUD8075HPL	BUD80HPLN		HPL Soft Touch by Fenix with MDF	black	5.729 DKK
	BUD80HPLB		HPL with MDF	white	5.729 DKK

Suggested maximum number of seats per table, calculated with an Aleta chair. The number of seats may vary depending on the chair model.

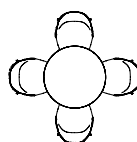
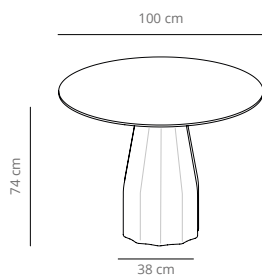

Table diameter 100



67.4 kg
 (x1) 59x55x89 cm (0.29 m³)
 (x1) 116x116x7 cm (0.09 m³)

CODE		BASE	FINISHES		PUBLIC PRICE
			TOP		
VCBBUD10075HM	BUD100M	white, black or taupe	melamine	white or black	4.797 DKK
VCBBUD10087	BUD100		stained	matt oak, cognac, ash, bleached oak or walnut	5.712 DKK
	BUD100TX		lacquered (microtexturized)	white or black	7.060 DKK
taupe, brick, ochre, olive green, dusty pink or dusty green				7.170 DKK	
VCBBUD10047	BUD100CN		compact laminate (black edge)	black	7.466 DKK
	BUD100CB		compact laminate (white edge)	white	7.466 DKK
VCBBUD10075HPL	BUD100HPLN		HPL Soft Touch by Fenix with MDF	black	7.119 DKK
	BUD100HPLB		HPL with MDF	white	7.119 DKK

Suggested maximum number of seats per table, calculated with an Aleta chair. The number of seats may vary depending on the chair model.

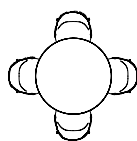

Burin

2018, BY PATRICIA URQUIOLA

TABLES

Test certificates: UNE-EN 15372:2017, UNE-EN 527-1:2011, UNE EN 527-2:2017 A1:2019

Table diameter 120

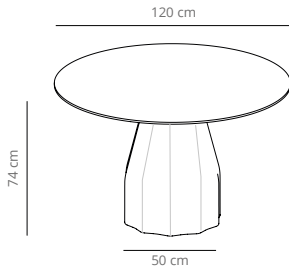

96.6 kg
 (x1) 59x55x89cm (0.29 m³)
 (x1) 136x136x7 cm (0.13 m³)

CODE		FINISHES		PUBLIC PRICE	
		BASE	TOP		
VCBBUD12075HM	BUD120M	white, black or taupe	melamine	white or black	5.882 DKK
VCBBUD12087	BUD120		stained	matt oak, cognac, ash, bleached oak or walnut	6.958 DKK
	BUD120TX		lacquered (microtexturized)	white or black	8.458 DKK
taupe, brick, ochre, olive green, dusty pink or dusty green				8.560 DKK	
VCBBUD12047	BUD120CN		compact laminate (black edge)	black	8.924 DKK
	BUD120CB		compact laminate (white edge)	white	8.924 DKK
VCBBUD12075HPL	BUD120HPLN		HPL Soft Touch by Fenix with MDF	black	8.500 DKK
	BUD120HPLB		HPL with MDF	white	8.500 DKK

Suggested maximum number of seats per table, calculated with an Aleta chair. The number of seats may vary depending on the chair model.

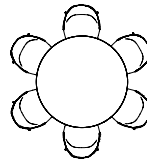
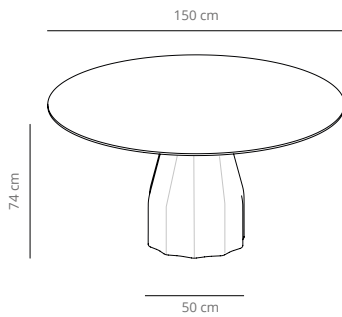

Table diameter 150



109 kg
 (x1) 59x55x89cm (0.29 m³)
 (x1) 178x166x7 cm (0.21 m³)

CODE		FINISHES		PUBLIC PRICE	
		BASE	TOP		
VCBBUD15075HM	BUD150M	white, black or taupe	melamine	white or black	7.416 DKK
VCBBUD15087	BUD150		stained	matt oak, cognac, ash, bleached oak or walnut	8.670 DKK
VCBBUD15087	BUD150TX		lacquered (microtexturized)	white or black	10.789 DKK
				taupe, brick, ochre, olive green, dusty pink or dusty green	10.899 DKK
VCBBUD15047	BUD150CN		compact laminate (black edge)	black	11.323 DKK
	BUD150CB		compact laminate (white edge)	white	11.323 DKK

Suggested maximum number of seats per table, calculated with an Aleta chair. The number of seats may vary depending on the chair model.

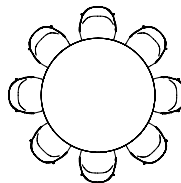

TABLES

Test certificates: UNE-EN 15372:2017, UNE-EN 527-1:2011, UNE EN 527-2:2017 A1:2019

Table 70x70

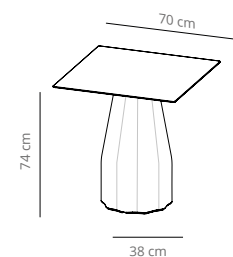

59.8 kg
 (x1) 59x55x89 cm (0.29 m³)
 (x1) 76x76x7 cm (0.04 m³)

CODE		BASE	FINISHES		PUBLIC PRICE
			TOP		
VCBBUC7075HM	BUC70M	white, black or taupe	melamine	white or black	3.805 DKK
VCBBUC7087	BUC70		stained	matt oak, cognac, ash, bleached oak or walnut	4.356 DKK
	BUC70TX		lacquered (microtexturized)	white or black	4.526 DKK
taupe, brick, ochre, olive green, dusty pink or dusty green				4.610 DKK	
VCBBUC7047	BUC70CN		compact laminate (black edge)	black	4.890 DKK
	BUC70CB		compact laminate (white edge)	white	4.890 DKK
VCBBUC7075HPL	BUC70HPLN		HPL Soft Touch by Fenix with MDF	black	4.653 DKK
	BUC70HPLB		HPL with MDF	white	4.653 DKK

Suggested maximum number of seats per table, calculated with an Aleta chair. The number of seats may vary depending on the chair model.

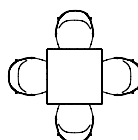

NOTE: The melamine tops come in a square shape, not in a rounded corner shape.

Table 80x80

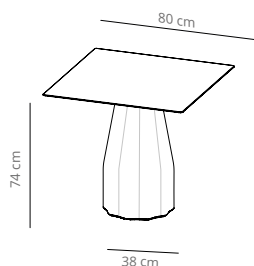

62.8 kg
 (x1) 59x55x89 cm (0.29 m³)
 (x1) 96x96x7 cm (0.06 m³)

CODE		BASE	FINISHES		PUBLIC PRICE
			TOP		
VCBBUC8075HM	BUC80M	white, black or taupe	melamine	white or black	4.153 DKK
VCBBUC8087	BUC80		stained	matt oak, cognac, ash, bleached oak or walnut	5.034 DKK
	BUC80TX		lacquered (microtexturized)	white or black	5.653 DKK
taupe, brick, ochre, olive green, dusty pink or dusty green				5.763 DKK	
VCBBUC8047	BUC80CN		compact laminate (black edge)	black	6.026 DKK
	BUC80CB		compact laminate (white edge)	white	6.026 DKK
VCBBUC8075HPL	BUC80HPLN		HPL Soft Touch by Fenix with MDF	black	5.729 DKK
	BUC80HPLB		HPL with MDF	white	5.729 DKK

Suggested maximum number of seats per table, calculated with an Aleta chair. The number of seats may vary depending on the chair model.

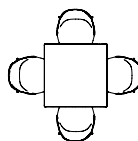

NOTE: The melamine tops come in a square shape, not in a rounded corner shape.

Burin

2018, BY PATRICIA URQUIOLA

TABLES

Test certificates: UNE-EN 15372:2017, UNE-EN 527-1:2011, UNE EN 527-2:2017 A1:2019

Table 90x90

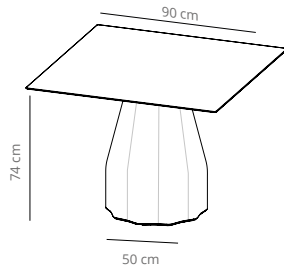

70.3 kg
 (x1) 59x55x89 cm (0.29 m³)
 (x1) 96x96x7 cm (0.06 m³)

CODE		BASE	FINISHES		PUBLIC PRICE
			TOP		
VCBBUC9075HM	BUC90M	white, black or taupe	melamine	white or black	4.399 DKK
VCBBUC9087	BUC90		stained	matt oak, cognac, ash, bleached oak or walnut	5.348 DKK
	BUC90TX		lacquered (microtexturized)	white or black	6.433 DKK
taupe, brick, ochre, olive green, dusty pink or dusty green				6.483 DKK	
VCBBUC9047	BUC90CN		compact laminate (black edge)	black	6.755 DKK
	BUC90CB		compact laminate (white edge)	white	6.755 DKK
VCBBUC9075HPL	BUC90HPLN		HPL Soft Touch by Fenix with MDF	black	6.424 DKK
	BUC90HPLB		HPL with MDF	white	6.424 DKK

Suggested maximum number of seats per table, calculated with an Aleta chair. The number of seats may vary depending on the chair model.

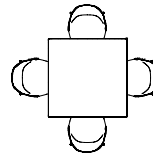

NOTE: The melamine tops come in a square shape, not in a rounded corner shape.

Table 100x100

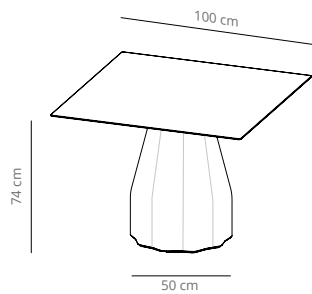

95.7 kg
 (x1) 59x55x89 cm (0.29 m³)
 (x1) 116x116x7 cm (0.09 m³)

CODE		BASE	FINISHES		PUBLIC PRICE
			TOP		
VCBBUC10075HM	BUC100M	white, black or taupe	melamine	white or black	4.797 DKK
VCBBUC10087	BUC100		stained	matt oak, cognac, ash, bleached oak or walnut	5.712 DKK
	BUC100TX		lacquered (microtexturized)	white or black	7.060 DKK
taupe, brick, ochre, olive green, dusty pink or dusty green				7.170 DKK	
VCBBUC10047	BUC100CN		compact laminate (black edge)	black	7.466 DKK
	BUC100CB		compact laminate (white edge)	white	7.466 DKK
VCBBUC10075HPL	BUC100HPLN		HPL Soft Touch by Fenix with MDF	black	7.119 DKK
	BUC100HPLB		HPL with MDF	white	7.119 DKK

Suggested maximum number of seats per table, calculated with an Aleta chair. The number of seats may vary depending on the chair model.

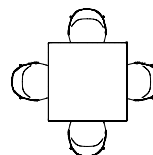

NOTE: The melamine tops come in a square shape, not in a rounded corner shape.

TABLES

Test certificates: UNE-EN 15372:2017, UNE-EN 527-1:2011, UNE EN 527-2:2017 A1:2019

Table 240x120

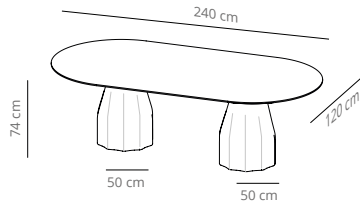

206 kg
 (x2) 59x55x89 cm (0.29 m³)
 (x1) 267x149x27 cm (1.07 m³)

CODE		FINISHES		PUBLIC PRICE	
		BASE	TOP		
VCBBUC24087	BUC240	white, black or taupe	stained	matt oak, cognac, ash, bleached oak or walnut	15.569 DKK
	BUC240TX		lacquered (microtexturized)	white or black	12.204 DKK
taupe, brick, ochre, olive green, dusty pink or dusty green				12.306 DKK	
VCBBUC24047	BUC240CN	compact laminate (black edge)	black	12.772 DKK	
	BUC240CB	compact laminate (white edge)	white	12.772 DKK	

Suggested maximum number of seats per table, calculated with an Aleta chair. The number of seats may vary depending on the chair model.

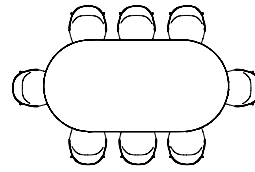
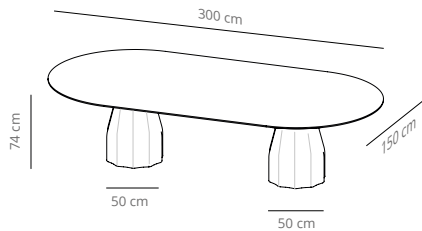

Table 300x150



245.8 kg
 (x2) 59x55x89 cm (0.29 m³)
 (x1) 330x180x27 cm (1.6 m³)

CODE		FINISHES		PUBLIC PRICE	
		BASE	TOP		
VCBBUC30087	BUC300	white, black or taupe	stained	matt oak, cognac, ash, bleached oak or walnut	25.739 DKK
	BUC300TX		lacquered (microtexturized)	white or black	18.840 DKK
taupe, brick, ochre, olive green, dusty pink or dusty green				18.942 DKK	

Suggested maximum number of seats per table, calculated with an Aleta chair. The number of seats may vary depending on the chair model.

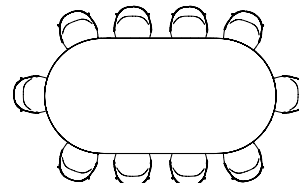

Burin

2018, BY PATRICIA URQUIOLA

TABLES

Table 500x150

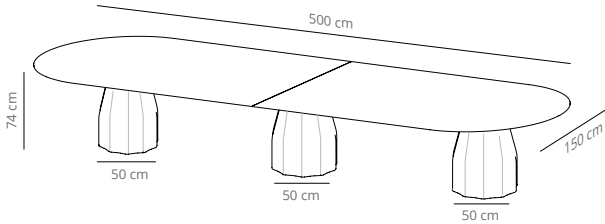

- 📦 397 kg
- 📦 (x3) 59x55x89 cm (0.29 m³)
- 📦 (x2) 281x176x10 cm (0.49 m³)

CODE		FINISHES		PUBLIC PRICE	
		BASE	TOP		
VCBBUC50087	BUC500	white, black or taupe	stained	matt oak, cognac, ash, bleached oak or walnut	35.392 DKK
	BUC500TX		lacquered (microtexturized)	white or black	29.849 DKK
					taupe, brick, ochre, olive green, dusty pink or dusty green

Suggested maximum number of seats per table, calculated with an Aleta chair. The number of seats may vary depending on the chair model.

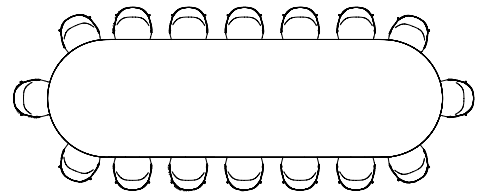

HEIGHT 102

Test certificates: UNE-EN 15372:2017, UNE-EN 527-1:2011, UNE EN 527-2:2017 A1:2019

Table diameter 60

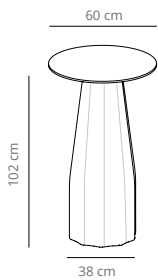

- 📦 37.2 kg
- 📦 (x1) 59x55x105 cm (0.34 m³)
- 📦 (x1) 76x76x7 cm (0.04 m³)

CODE		FINISHES		PUBLIC PRICE	
		BASE	TOP		
VCBBUD60H75HM	BUD60HM	white, black or taupe	melamine	white or black	4.305 DKK
VCBBUD60H87	BUD60H		stained	matt oak, cognac, ash, bleached oak or walnut	5.144 DKK
	BUD60HTX		lacquered (microtexturized)	white or black	5.238 DKK
taupe, brick, ochre, olive green, dusty pink or dusty green				5.238 DKK	
VCBBUD60H47	BUD60HCN		compact laminate (black edge)	black	5.602 DKK
	BUD60HCB		compact laminate (white edge)	white	5.602 DKK
VCBBUD60H75HPL	BUD60HHPLN		HPL Soft Touch by Fenix with MDF	black	5.339 DKK
	BUD60HHPLB		HPL with MDF	white	5.339 DKK

Suggested maximum number of seats per table, calculated with an Aleta chair. The number of seats may vary depending on the chair model.

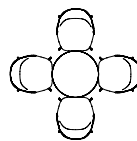

TABLES

Table diameter 70

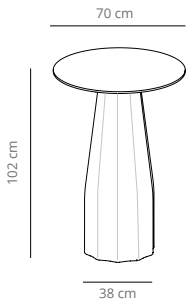

36.4 kg
 (x1) 59x55x105 cm (0.34 m³)
 (x1) 86x86x7 cm (0.05 m³)

CODE		FINISHES		PUBLIC PRICE	
		BASE	TOP		
VCBBUD70H75HM	BUD70HM	white, black or taupe	melamine	white or black	4.399 DKK
VCBBUD70H87	BUD70H		stained	matt oak, cognac, ash, bleached oak or walnut	5.238 DKK
	BUD70HTX		lacquered (microtexturized)	white or black	5.348 DKK
taupe, brick, ochre, olive green, dusty pink or dusty green				5.449 DKK	
VCBBUD70H47	BUD70HCN		compact laminate (black edge)	black	5.712 DKK
	BUD70HCB		compact laminate (white edge)	white	5.712 DKK
VCBBUD70H75HPL	BUD70HHPLN		HPL Soft Touch by Fenix with MDF	black	5.441 DKK
	BUD70HHPLB		HPL with MDF	white	5.441 DKK

Suggested maximum number of seats per table, calculated with an Aleta chair. The number of seats may vary depending on the chair model.

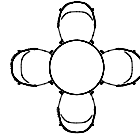
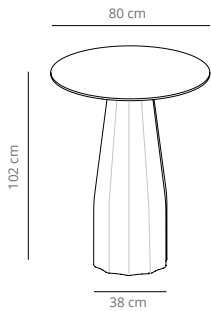

Table diameter 80



42.1 kg
 (x1) 59x55x105 cm (0.34 m³)
 (x1) 96x96x7 cm (0.06 m³)

CODE		FINISHES		PUBLIC PRICE	
		BASE	TOP		
VCBBUD80H75HM	BUD80HM	white, black or taupe	melamine	white or black	4.941 DKK
VCBBUD80H87	BUD80H		stained	matt oak, cognac, ash, bleached oak or walnut	5.856 DKK
	BUD80HTX		lacquered (microtexturized)	white or black	6.543 DKK
taupe, brick, ochre, olive green, dusty pink or dusty green				6.644 DKK	
VCBBUD80H47	BUD80HCN		compact laminate (black edge)	black	6.958 DKK
	BUD80HCB		compact laminate (white edge)	white	6.958 DKK
VCBBUD80H75HPL	BUD80HHPLN		HPL Soft Touch by Fenix with MDF	black	6.627 DKK
	BUD80HHPLB		HPL with MDF	white	6.627 DKK

Suggested maximum number of seats per table, calculated with an Aleta chair. The number of seats may vary depending on the chair model.

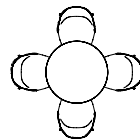

Burin

2018, BY PATRICIA URQUIOLA

TABLES

Test certificates: UNE-EN 15372:2017, UNE-EN 527-1:2011, UNE EN 527-2:2017 A1:2019

Table diameter 100

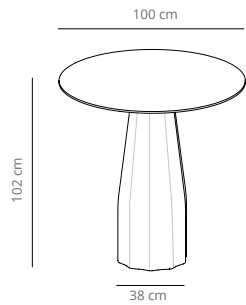

49.2 kg
 (x1) 59x55x105 cm (0.34 m³)
 (x1) 116x116x7 cm (0.08 m³)

CODE		BASE	FINISHES		PUBLIC PRICE
			TOP		
VCBBUD100H75HM	BUD100HM	white, black or taupe	melamine	white or black	5.975 DKK
VCBBUD100H87	BUD100H		stained	matt oak, cognac, ash, bleached oak or walnut	7.009 DKK
	BUD100HTX		lacquered (microtexturized)	white or black	7.678 DKK
taupe, brick, ochre, olive green, dusty pink or dusty green				7.797 DKK	
VCBBUD100H47	BUD100HCN		compact laminate (black edge)	black	8.043 DKK
	BUD100HCB		compact laminate (white edge)	white	8.043 DKK
VCBBUD100H75HPL	BUD100HHPLN		HPL Soft Touch by Fenix with MDF	black	7.661 DKK
	BUD100HHPLB		HPL with MDF	white	7.661 DKK

Suggested maximum number of seats per table, calculated with an Aleta chair. The number of seats may vary depending on the chair model.

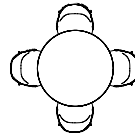
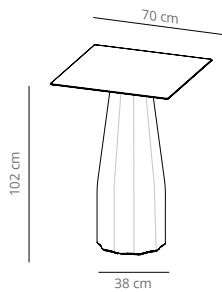

Table 70x70



41.6 kg
 (x1) 59x55x105 cm (0.34 m³)
 (x1) 77x77x7 cm (0.04 m³)

CODE		BASE	FINISHES		PUBLIC PRICE
			TOP		
VCBBUC70H75HM	BUC70HM	white, black or taupe	melamine	white or black	4.399 DKK
VCBBUC70H87	BUC70H		stained	matt oak, cognac, ash, bleached oak or walnut	5.238 DKK
	BUC70HTX		lacquered (microtexturized)	white or black	5.348 DKK
taupe, brick, ochre, olive green, dusty pink or dusty green				5.449 DKK	
VCBBUC70H47	BUC70HCN		compact laminate (black edge)	black	5.712 DKK
	BUC70HCB		compact laminate (white edge)	white	5.712 DKK
VCBBUC70H75HPL	BUC70HHPLN		HPL Soft Touch by Fenix with MDF	black	5.441 DKK
	BUC70HHPLB		HPL with MDF	white	5.441 DKK

Suggested maximum number of seats per table, calculated with an Aleta chair. The number of seats may vary depending on the chair model.

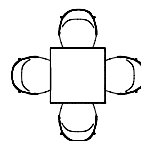

NOTE: The melamine tops come in a square shape, not in a rounded corner shape.

TABLES

Test certificates: UNE-EN 15372:2017, UNE-EN 527-1:2011, UNE EN 527-2:2017 A1:2019

Table 80x80

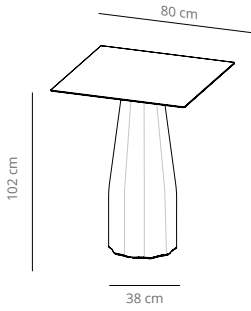

- 44.6 kg
- (x1) 59x55x105 cm (0.34 m³)
- (x1) 87x87x7 cm (0.05 m³)

CODE		BASE	FINISHES		PUBLIC PRICE
			TOP		
VCBBUC80H75HM	BUC80HM	white, black or taupe	melamine	white or black	4.941 DKK
VCBBUC80H87	BUC80H		stained	matt oak, cognac, ash, bleached oak or walnut	5.856 DKK
	BUC80HTX		lacquered (microtexturized)	white or black	6.543 DKK
				taupe, brick, ochre, olive green, dusty pink or dusty green	6.644 DKK
VCBBUC80H47	BUC80HCN		compact laminate (black edge)	black	6.958 DKK
	BUC80HCB		compact laminate (white edge)	white	6.958 DKK
VCBBUC80H75HPL	BUC80HHPLN		HPL Soft Touch by Fenix with MDF	black	6.627 DKK
	BUC80HHPLB		HPL with MDF	white	6.627 DKK

Suggested maximum number of seats per table, calculated with an Aleta chair. The number of seats may vary depending on the chair model.

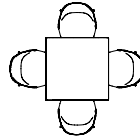

ACCESSORIES AND POWER OPTIONS

For the different table tops, we offer the possibility of installing the following accessories and power options. The drawings with the location of the accessories need the approval of the technical department.

Pop-up sockets

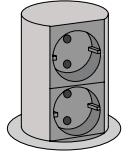

0.6 kg
(x1) 21x16x16cm (0.005 m³)

CODE	FINISHES	PUBLIC PRICE
-	BUTC	by model* 3.009 DKK

Built-in pop-up socket cylinder can have 2 Schuko sockets or 1 Schuko socket + 2 USB hubs. For different configurations, contact the sales department.

The cylinder is hidden and pops up by gently pressing on it, offering the possibility of connection on four sides.

The finish can vary depending on the internal configuration. For more information, please contact our sales department.

NOTE: The cut out is included only if it is in the center of the base column.

USB hub

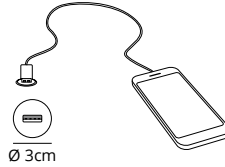

Installed and included in the table top box

CODE	FINISHES	PUBLIC PRICE
-	BUUSB	white or black 525 DKK

Built-in USB hub for charging electronic devices.

Available in black or white.

Dimensions: Ø 3 cm

NOTE: The cut out is included if it coincides with the center of the base column. It is not included for other positions.

Cut out

CODE	PUBLIC PRICE
-	BUMEC 1.093 DKK

Custom table top measure. The price is per table top.

Table top hatch



1.2 kg
(x1) 34x18x9cm (0.005 m³)

CODE	FINISHES	PUBLIC PRICE
VCBCAP*	CAP*	white or black 1.246 DKK

Metallic hatch access to the lower part of the table.

Available in white, black or grey. Does not include power options.

Dimensions: 32x15 cm

* Cut out not included.

NOTE: Not available for compact tabletops.

NOTE: Only available for models: BUC140, BUD150, BUC240, BUC300 and BUC500.

Table top hatch plus

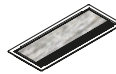

1.2 kg
(x1) 34x18x9cm (0.005 m³)

CODE	FINISHES	PUBLIC PRICE
VCBCAPP*	CAPP*	white or black 1.500 DKK

Metallic hatch access to the lower part of the table for wooden table tops. Metal frame available in black or grey and central part in the veneer of the finish of the table. Does not include power options.

Dimensions: 32x15 cm

* Cut out not included.

NOTE: Not available for compact tabletops.

NOTE: Only available for models: BUC140, BUD150, BUC240, BUC300 and BUC500.

TABLES

Table top hatch powerbox



1.7 kg

(x1) 34x18x9cm (0.005 m³)

CODE		FINISHES	PUBLIC PRICE
-	BOX-E*	white or black	2.441 DKK
-	BOX-M*		3.534 DKK

BOX-E: 4 sockets

BOX-M: 4 devices (sockets and multimedia)

Metallic hatch with 4 sockets or combined with built-in multimedia devices.

Available in white, black or grey

Dimensions: 32x15 cm

* Cut out not included.

For all available power options [see page 505](#).

NOTE: Not available for compact table tops.

NOTE: Only available for the models: BUC140,

BUD150, BUC240, BUC300 and BUC500.

Table top hatch powerbox plus

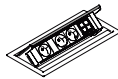

1.7 kg

(x1) 34x18x9cm (0.005 m³)

CODE		FINISHES	PUBLIC PRICE
-	BOXP-E*	white or black	3.534 DKK
-	BOXP-M*		4.610 DKK

BOXP-E: 4 sockets

BOXP-M: 4 devices (sockets and multimedia)

Metallic hatch for wooden table tops with 4 sockets or combined with built-in multimedia devices. Metal frame available in black or grey and central part in the veneer of the finish of the table.

Dimensions: 32x15 cm

* Cut out not included.

For all available power options [see page 505](#).

NOTE: Not available for compact table tops.

NOTE: Only available for the models: BUC140,

BUD150, BUC240, BUC300 and BUC500.

Each hatch has 4 modules (sockets or multimedia devices) to install power options. The modules can be complete (1) or half module. (1/2).

The power options are under the UNE-EN 50085 standards.

For the references BOX-E, BOX-M, BOXP-E, BOXP-M y BUEL-E the cable length is 0.3 meters with Wieland connector. The power connection cable is not included, and will have to be provided by the customer.

NOTE: Power options not available for models BUC500 and BUC500TX if it interferes with the center leg.

Under table powerbox

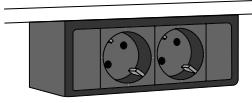

1.7 kg
 (x1) 17x18x9cm (0.005 m³)

CODE		FINISHES	PUBLIC PRICE
VCBBUELE	BUEL-E	black	2.814 DKK

Powerbox available with 2 sockets or combined with built-in multimedia devices

For all available power options *see page 505*.

NOTE: Not available for compact table tops.

USB hub with battery

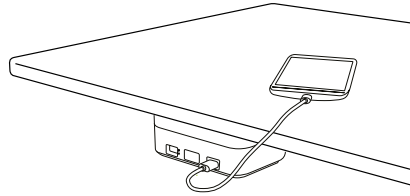

1.4 kg
 (x1) 40x20x25cm (0.02 m³)

CODE		FINISHES	PUBLIC PRICE
VCBBUELB	BUEL-B	black	2.187 DKK

USB hub with two USB device charging ports without being plugged into electric current.

It's needed to buy the battery charging tray to charge the USB hub battery.

Battery charging tray

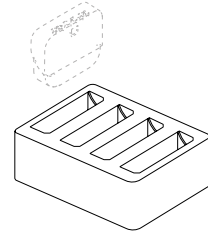

1 kg
 (x1) 40x20x25cm (0.02 m³)

CODE		FINISHES	PUBLIC PRICE
VCBBUELC	BUEL-C	black	2.542 DKK

Battery charging tray. Charges up to four stations simultaneously in 7 hours. Includes magnetic key to remove the station from its support.

TABLES

POWER POSITION OPTIONS

We have curated a selection of cut out positions from the most demanded due to its polyvalence and flexibility. Please contact our sales team in case you need a quote for specials, we are open to listen to your needs. For other options, please contact the sales department, indicating the cut out reference in the order.

TABLES 40 x 120 cm

240 A

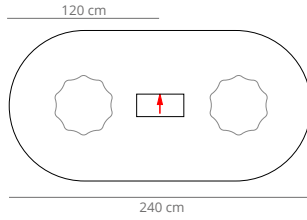

240 B

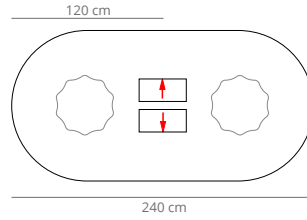

240 C

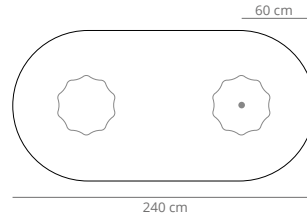

240 D

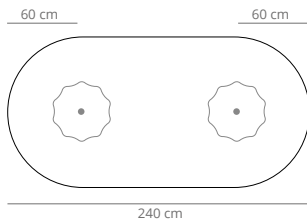

240 E

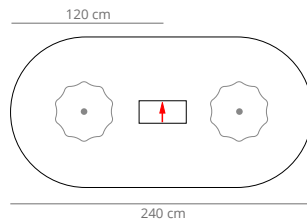

TABLES 300 x 150 cm

300 A

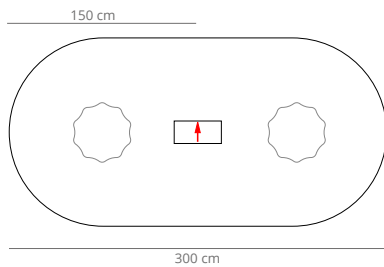

300 B

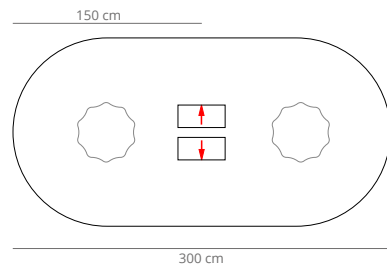

300 C

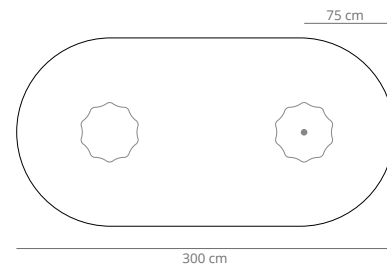

300 D

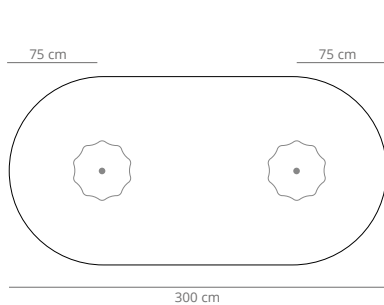

300 E

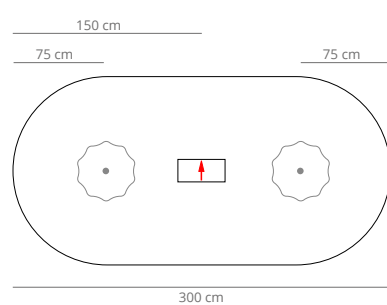

300 F

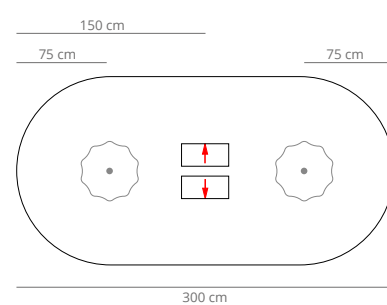

 The rectangle represents a standard powerbox (32x15 cm), compatible with references CAP, CAPP, BOX-E, BOX-M, BOX-P-E y BOX-P-M. The arrow points out the opening side.

- The circle represents the column centered option for cut out and power options, only compatible for references BUMEC, BUTC and BUUSB.

TABLES 500 x 150 cm

500 A

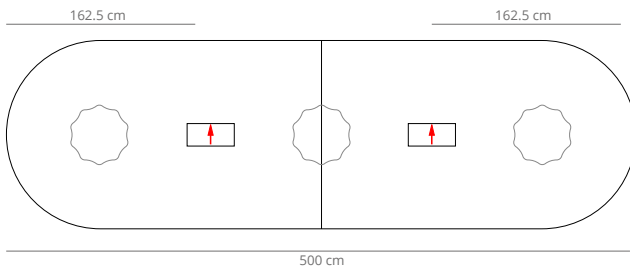

500 B

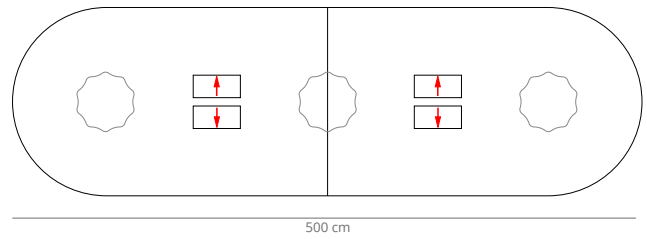

500 C

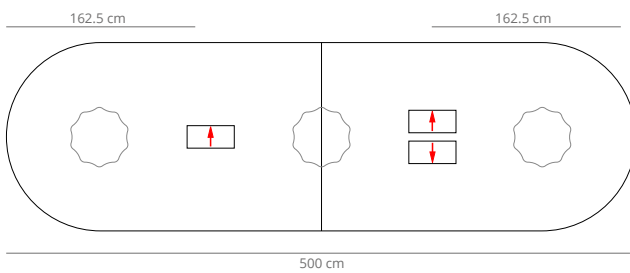

500 D

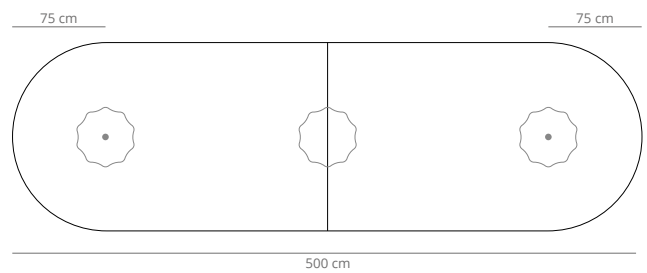

500 E

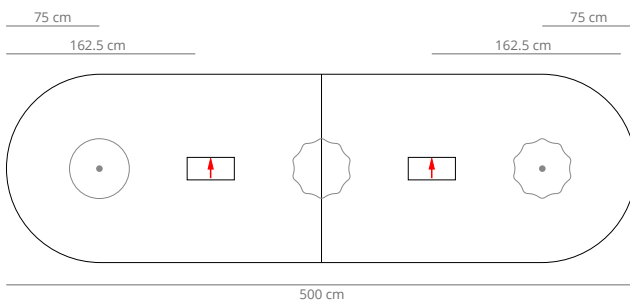

500 F

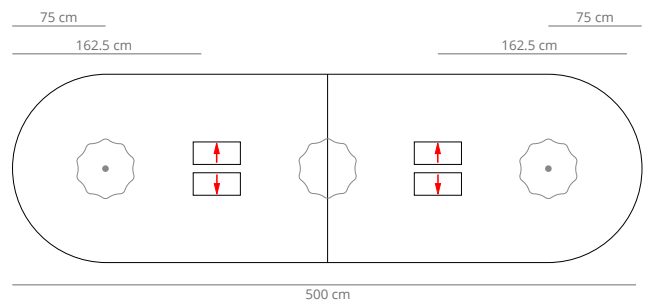

The rectangle represents a standard powerbox (32x15 cm), compatible with references CAP, CAPP, BOX-E, BOX-M, BOXP-E y BOXP-M. The arrow points out the opening side.

- The circle represents the column centered option for cut out and power options, only compatible for references BUMEC, BUTC and BUUSB



Trestle

BY JOHN PAWSON

TABLES

Test certificates: ANSI/BIFMA X5.5:2014, UNE-EN 15372:2017, UNE-EN 527-1:2011 and UNE EN 527-2:2017 A1:2019

The elegance of Pawson surprises us once again with this immense table and bench of exquisite proportions, for tables 74 cm height, 88 cm counter height and 105 cm bar height.

Stained solid oak, solid beech legs and metal legs lacquered with the finishes of our collection.

Due to the fact that the wood used is natural, the finish may vary. Beam in calibrated powder coated tube in thermoreinforced polyester in graphite grey (RAL9007).

The table top is available in two different finishes and widths (90 cm and 120 cm):

- 30 mm MDF board with a natural oak veneer polished in matt, cognac, ash or wenge. Also available in micro-textured lacquer in white, black or taupe.
- High pressure HPL laminate in black or white on a 30 mm thick MDF board with stained edges in transparent.

NOTE: For tables equal to, or longer than 480 cm, the production delay is two additional weeks respect the normal production term.

Thickness and type of table top edge:

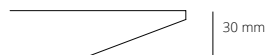

More information about table tops on page 21

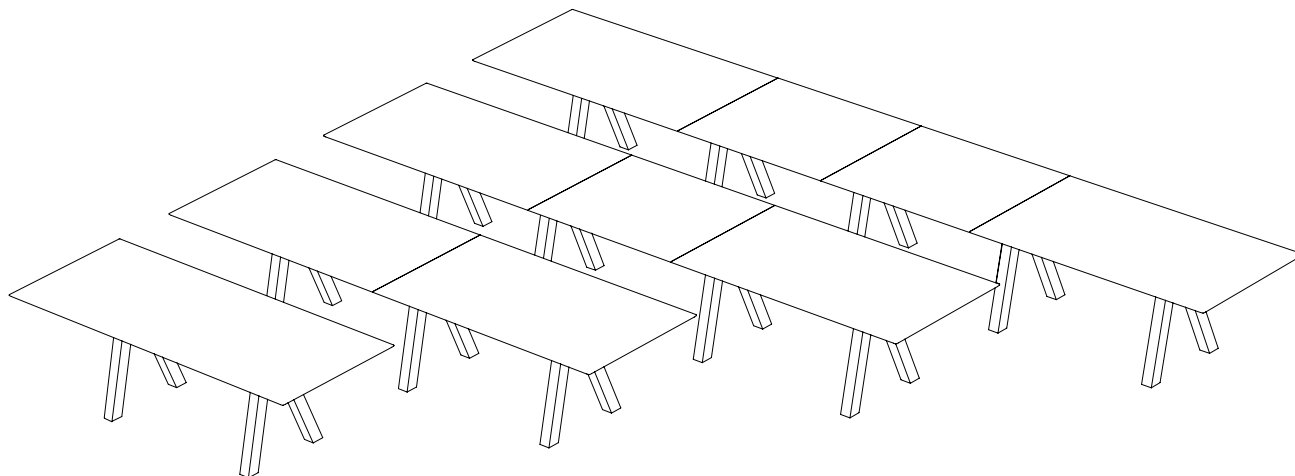

Trestle

2014, BY JOHN PAWSON

TABLES

TABLE TOP OPTIONS

HEIGHT 74

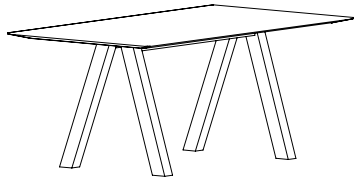

Width 90

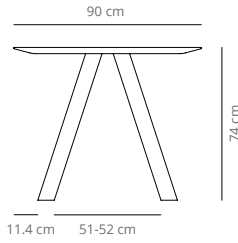

Width 120

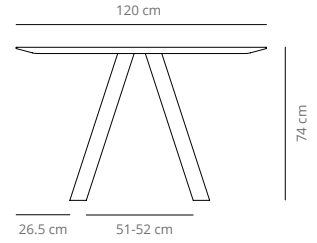

HEIGHT 88



Width 90

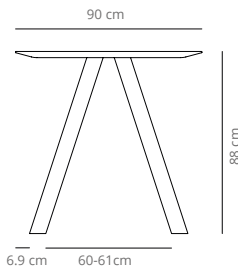

Width 120

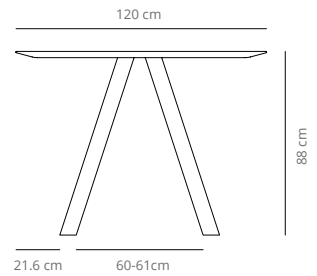

HEIGHT 105

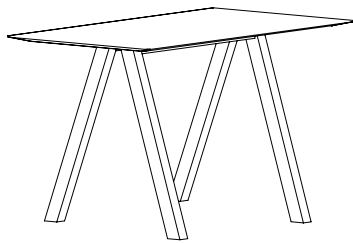

Width 90

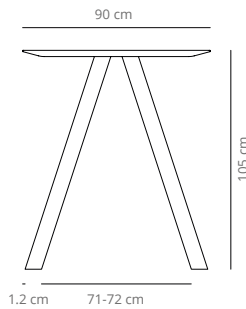

Width 120

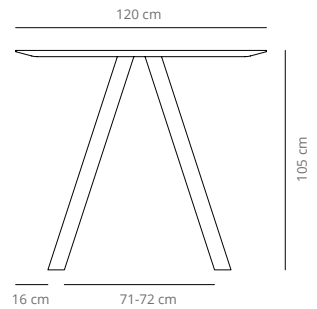

For 200 cm table length

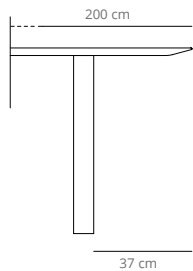

For 240 cm / 360 cm / 420 cm table length

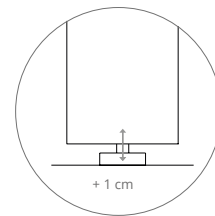
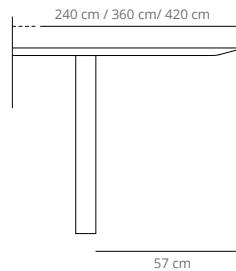

ADJUSTABLE HEIGHT LEGS

TABLES

HEIGHT 74 cm

Table 200 cm

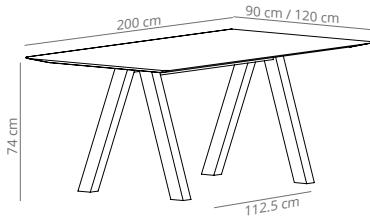

FINISHES			CODE	PUBLIC PRICE	CODE	PUBLIC PRICE		
LEGS	TOP		WIDTH 120		WIDTH 90			
metal: black or white	stained	matt oak	VCBTRMSCA	TRMESCROA	15.933 DKK	VC MS	TRMESCRO	12.712 DKK
		cognac, ash, bleached oak or walnut		18.060 DKK	13.814 DKK			
	lacquered (microtexturized)	white or black		TRMESCTXA	15.933 DKK		TRMESCTX	12.712 DKK
		taupe		16.238 DKK	12.975 DKK			
	HPL Soft Touch by Fenix with MDF	black		TRMESCHPLAN	16.704 DKK		TRMESCHPLN	14.136 DKK
		white		TRMESCHPLAB	16.704 DKK		TRMESCHPLB	14.136 DKK
stained (oak): matt oak, cognac, ash, bleached oak or walnut	stained	matt oak	TRMSCROA	20.137 DKK	TRMSCRO	15.679 DKK		
		cognac, ash, bleached oak or walnut	21.077 DKK	16.450 DKK				
lacquered microtexturized (beech): white, black or taupe	lacquered (microtexturized)	white or black	TRMSCTXA	20.552 DKK	TRMSCTX	16.035 DKK		
		taupe	21.077 DKK	16.450 DKK				
	HPL Soft Touch by Fenix with MDF	black	TRMSCHPLAN	20.365 DKK	TRMSCHPLN	17.840 DKK		
		white	TRMSCHPLAB	20.365 DKK	TRMSCHPLB	17.840 DKK		

90 cm: 66.6 kg
 (x1) 218x108x8cm (0.19 m³)
 (x1) 119x18x9cm (0.02 m³)
 (x2) 77x29x75cm (0.17 m³)

120 cm: 91.6 kg
 (x1) 218x139x8 cm (0.24 m³)
 (x1) 119x18x9cm (0.02 m³)
 (x2) 77x29x75cm (0.17 m³)

+ 177€



It is possible to add a built-in wire management system (TRPMR) in a leg for an extra of 177€. It has to be indicated in the order with its reference. To see the position options for the wire management leg, see page 467.

NOTES:
 Due to the fact that the wood used is natural, the finish may vary.

All of the weights are calculated considering the option of the wooden leg.

Suggested maximum number of seats per table, calculated with an Aleta chair. The number of seats may vary depending on the chair model.

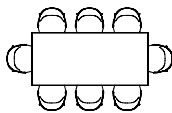
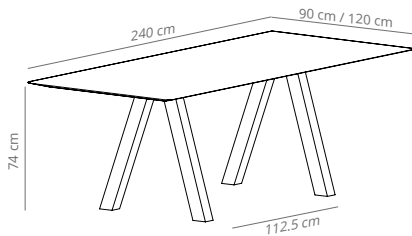

Table 240 cm



FINISHES			CODE	PUBLIC PRICE	CODE	PUBLIC PRICE		
LEGS	TOP		WIDTH 120		WIDTH 90			
metal: black or white	stained	matt oak	VCBTRMSA	TRMESROA	18.060 DKK	VC	TRMESRO	13.814 DKK
		cognac, ash, bleached oak or walnut		20.179 DKK	14.848 DKK			
	lacquered (microtexturized)	white or black		TRMESTXA	18.060 DKK		TRMESTX	13.814 DKK
		taupe		18.425 DKK	14.068 DKK			
	HPL Soft Touch by Fenix with MDF	black		TRMESHPLAN	18.492 DKK		TRMESHPLN	15.179 DKK
	HPL with MDF	white		TRMESHPLAB	18.492 DKK		TRMESHPLB	15.179 DKK
stained (oak): matt oak, cognac, ash, bleached oak or walnut	stained	matt oak	TRMSROA	23.408 DKK	TRMSRO	16.450 DKK		
		cognac, ash, bleached oak or walnut	24.450 DKK	17.340 DKK				
lacquered microtexturized (beech): white, black or taupe	lacquered (microtexturized)	white or black	TRMSTXA	23.823 DKK	TRMSTX	16.857 DKK		
		taupe	24.450 DKK	17.340 DKK				
	HPL Soft Touch by Fenix with MDF	black	TRMSHPLAN	22.145 DKK	TRMSHPLN	18.831 DKK		
	HPL with MDF	white	TRMSHPLAB	22.145 DKK	TRMSHPLB	18.831 DKK		

90 cm: 73.3 kg
 (x1) 258x108x8cm (0.19 m³)
 (x1) 119x18x9cm (0.02 m³)
 (x2) 77x29x75cm (0.17 m³)

120 cm: 130.6 kg
 (x1) 267x148x28 cm (0.24 m³)
 (x1) 119x18x9cm (0.02 m³)
 (x2) 77x29x75cm (0.17 m³)

+ 177€



It is possible to add a built-in wire management system (TRPMR) in a leg for an extra of 177€. It has to be indicated in the order with its reference. To see the position options for the wire management leg, see page 467.

NOTES:
 Due to the fact that the wood used is natural, the finish may vary.

All of the weights are calculated considering the option of the wooden leg.

Suggested maximum number of seats per table, calculated with an Aleta chair. The number of seats may vary depending on the chair model.

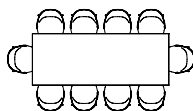

TABLES

Double table

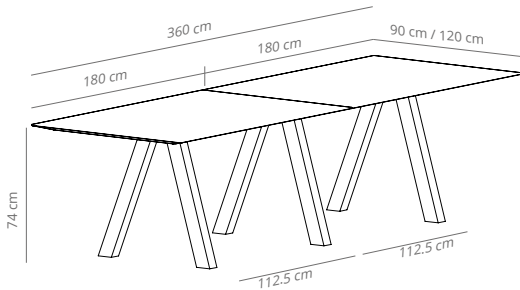

FINISHES			CODE	PUBLIC PRICE	CODE	PUBLIC PRICE	
LEGS	TOP		WIDTH 120		WIDTH 90		
metal: black or white	stained	matt oak	VCBTRMDA	26.620 DKK	V	20.662 DKK	
		cognac, ash, bleached oak or walnut		TRMEDROA		27.713 DKK	TRMEDRO
	lacquered (microtexturized)	white or black		27.239 DKK		21.281 DKK	
		taupe		27.815 DKK		21.594 DKK	
	HPL Soft Touch by Fenix with MDF	black		TRMEDHPLAN		39.095 DKK	TRMEDHPLN
HPL with MDF	white	TRMEDHPLAB	39.095 DKK	TRMEDHPLB	30.934 DKK		
stained (oak): matt oak, cognac, ash, bleached oak or walnut	stained	matt oak	32.383 DKK	26.417 DKK			
		cognac, ash, bleached oak or walnut	TRMDROA	33.476 DKK	TRMDRO	27.145 DKK	
lacquered microtexturized (beech): white, black or taupe	lacquered (microtexturized)	white or black	33.061 DKK	27.035 DKK			
		taupe	33.586 DKK	27.349 DKK			
	HPL Soft Touch by Fenix with MDF	black	TRMDHPLAN	44.587 DKK	TRMDHPLN	36.426 DKK	
	HPL with MDF	white	TRMDHPLAB	44.587 DKK	TRMDHPLB	36.426 DKK	

90 cm: 116.4 kg
 (x2) 199x108x8 cm (0.17 m³)
 (x2) 119x18x9 cm (0.02 m³)
 (x3) 77x29x75 cm (0.17 m³)

120 cm: 161.2 kg
 (x2) 199x139x28 cm (0.22 m³)
 (x2) 119x18x9 cm (0.02 m³)
 (x3) 77x29x75 cm (0.17 m³)

+ 177€



It is possible to add a built-in wire management system (TRPMR) in a leg for an extra of 177€. It has to be indicated in the order with its reference. To see the position options for the wire management leg, see page 467.

NOTES:
 Due to the fact that the wood used is natural, the finish may vary.

All of the weights are calculated considering the option of the wooden leg.

Suggested maximum number of seats per table, calculated with an Aleta chair. The number of seats may vary depending on the chair model.

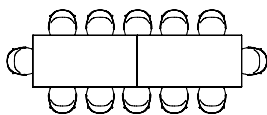

Triple table

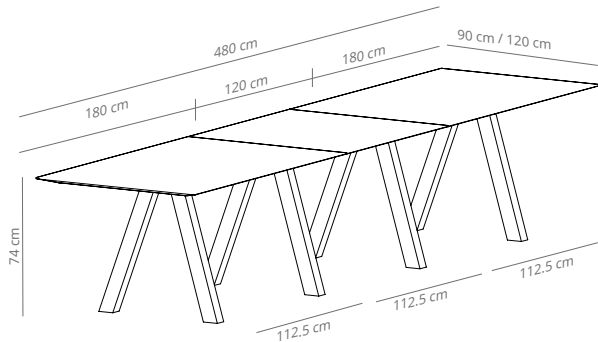

FINISHES			CODE	PUBLIC PRICE	CODE	PUBLIC PRICE
LEGS	TOP		WIDTH 120		WIDTH 90	
metal: black or white	stained	matt oak	TRMETROA	36.281 DKK	TRMETRO	28.340 DKK
		cognac, ash, bleached oak or walnut		37.731 DKK		29.315 DKK
	lacquered (microtexturized)	white or black	TRMETTXA	37.273 DKK	TRMETTX	29.171 DKK
		taupe		37.943 DKK		29.637 DKK
	HPL Soft Touch by Fenix with MDF	black	TRMETHPLAN	51.155 DKK	TRMETHPLN	40.527 DKK
	HPL with MDF	white	TRMETHPLAB	51.155 DKK	TRMETHPLB	40.527 DKK
stained (oak): matt oak, cognac, ash, bleached oak or walnut	stained	matt oak	TRMTROA	44.011 DKK	TRMTRO	36.027 DKK
		cognac, ash, bleached oak or walnut		45.460 DKK		37.061 DKK
	lacquered microtexturized (beech): white, black or taupe	white or black	TRMTTXA	44.951 DKK	TRMTTX	36.909 DKK
		taupe		45.672 DKK		37.315 DKK
	HPL Soft Touch by Fenix with MDF	black	TRMTHPLAN	58.469 DKK	TRMTHPLN	47.841 DKK
	HPL with MDF	white	TRMTHPLAB	58.469 DKK	TRMTHPLB	47.841 DKK

90 cm: 157.6 kg
 (x1) 138x108x8cm (0.12 m³)
 (x2) 199x108x8cm (0.17 m³)
 (x3) 119x18x9 cm (0.02 m³)
 (x4) 77x29x75 cm (0.17 m³)

120 cm: 215.3 kg
 (x1) 143x139x8 cm (0.22 m³)
 (x2) 199x139x8 cm (0.22 m³)
 (x3) 119x18x9 cm (0.02 m³)
 (x4) 77x29x75 cm (0.17 m³)

+ 177€



It is possible to add a built-in wire management system (TRPMR) in a leg for an extra of 177€. It has to be indicated in the order with its reference. To see the position options for the wire management leg, see page 467.

NOTES:
 The manufacturing lead time for 480 cm table tops (triples) is 2 weeks additional to the normal manufacturing lead time.

Due to the natural wood used, the finish may vary.

All weights are calculated considering the wooden legs.

Suggested maximum number of seats per table, calculated with an Aleta chair. The number of seats may vary depending on the chair model.

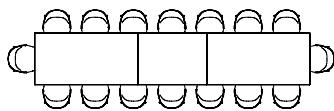

TABLES

HEIGHT 88 cm

Table 200 cm

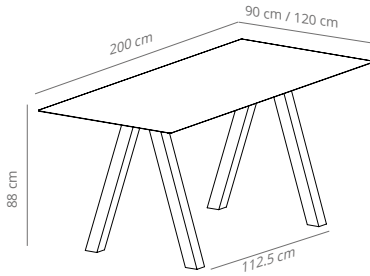

FINISHES			CODE	PUBLIC PRICE	CODE	PUBLIC PRICE
LEGS	TOP		WIDTH 120		WIDTH 90	
metal: black or white	stained	matt oak	VCBTRMSCAH	TRMESCROAH	16.145 DKK	12.924 DKK
		cognac, ash, bleached oak or walnut		TRMESCROH	18.272 DKK	14.009 DKK
	lacquered (microtexturized)	white or black		TRMESCTXAH	16.145 DKK	12.924 DKK
		taupe		TRMESCTXH	16.450 DKK	13.187 DKK
	HPL Soft Touch by Fenix with MDF	black		TRMESCHPLAHN	16.908 DKK	14.331 DKK
	HPL with MDF	white		TRMESCHPLAH	16.908 DKK	14.331 DKK
stained (oak): matt oak, cognac, ash, bleached oak or walnut	stained	matt oak	VCBTRMSCAH	TRMESCROAH	21.230 DKK	16.713 DKK
		cognac, ash, bleached oak or walnut		TRMESCROH	22.111 DKK	17.543 DKK
	lacquered microtexturized (beech): white, black or taupe	white or black		TRMESCTXAH	21.594 DKK	17.136 DKK
		taupe		TRMESCTXH	22.111 DKK	17.543 DKK
	HPL Soft Touch by Fenix with MDF	black		TRMESCHPLAHN	21.399 DKK	18.831 DKK
	HPL with MDF	white		TRMESCHPLAH	21.399 DKK	18.831 DKK

90 cm: 67.2 kg
 (x1) 218x108x8cm (0.19 m³)
 (x1) 119x18x9cm (0.02 m³)
 (x2) 91x29x85cm (0.22 m³)

120 cm: 92.2 kg
 (x1) 218x139x8 cm (0.24 m³)
 (x1) 119x18x9cm (0.02 m³)
 (x2) 91x29x85cm (0.22 m³)

+ 177€



It is possible to add a built-in wire management system (TRPMR) in a leg for an extra of 177€. It has to be indicated in the order with its reference. To see the position options for the wire management leg, see page 467.

NOTES:
 Due to the fact that the wood used is natural, the finish may vary.

All of the weights are calculated considering the option of the wooden leg.

Suggested maximum number of seats per table, calculated with an Aleta chair. The number of seats may vary depending on the chair model.

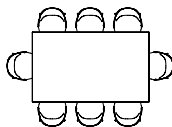
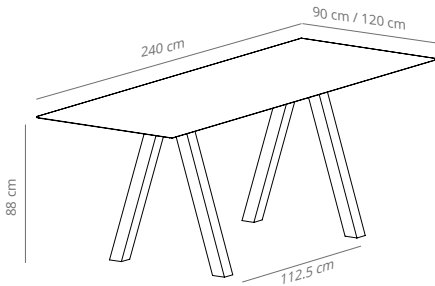

Table 240 cm



FINISHES			CODE	PUBLIC PRICE	CODE	PUBLIC PRICE
LEGS	TOP		WIDTH 120		WIDTH 90	
metal: black or white	stained	matt oak	TRMESROAH	18.272 DKK	TRMESROH	14.009 DKK
		cognac, ash, bleached oak or walnut		20.391 DKK		15.060 DKK
	lacquered (microtexturized)	white or black	TRMESTXAH	18.272 DKK	TRMESTXH	14.009 DKK
		taupe		18.637 DKK		14.280 DKK
	HPL Soft Touch by Fenix with MDF	black	TRMESHPLAHN	18.679 DKK	TRMESHPLHN	15.365 DKK
	HPL with MDF	white	TRMESHPLAHB	18.679 DKK	TRMESHPLHB	15.365 DKK
stained (oak): matt oak, cognac, ash, bleached oak or walnut	stained	matt oak	TRMSROAH	24.493 DKK	TRMSROH	17.543 DKK
		cognac, ash, bleached oak or walnut		25.484 DKK		18.382 DKK
lacquered microtexturized (beech): white, black or taupe	lacquered (microtexturized)	white or black	TRMSTXAH	24.916 DKK	TRMSTXH	17.959 DKK
		taupe		25.484 DKK		18.382 DKK
	HPL Soft Touch by Fenix with MDF	black	TRMSHPLAHN	23.188 DKK	TRMSHPLHN	19.874 DKK
	HPL with MDF	white	TRMSHPLAHB	23.188 DKK	TRMSHPLHB	19.874 DKK

90 cm: 73.3 kg
 (x1) 258x108x8cm (0.19 m³)
 (x1) 119x18x9cm (0.02 m³)
 (x2) 91x29x85cm (0.22 m³)

120 cm: 130.6 kg
 (x1) 267x148x28 cm (0.24 m³)
 (x1) 119x18x9cm (0.02 m³)
 (x2) 91x29x85cm (0.22 m³)

+ 177€



It is possible to add a built-in wire management system (TRPMR) in a leg for an extra of 177€. It has to be indicated in the order with its reference. To see the position options for the wire management leg, see page 467.

NOTES:
 Due to the fact that the wood used is natural, the finish may vary.

All of the weights are calculated considering the option of the wooden leg.

Suggested maximum number of seats per table, calculated with an Aleta chair. The number of seats may vary depending on the chair model.

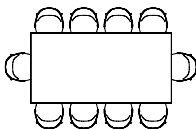

TABLES

Double table

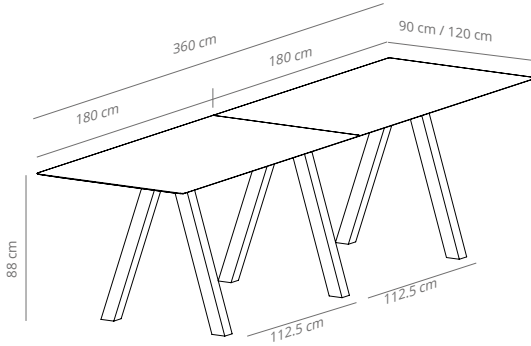

FINISHES		CODE	PUBLIC PRICE	CODE	PUBLIC PRICE
LEGS	TOP	WIDTH 120		WIDTH 90	
metal: black or white	stained	matt oak	26.934 DKK		20.967 DKK
		cognac, ash, bleached oak or walnut	TRMEDROAH 28.027 DKK	TRMEDROH	21.704 DKK
	lacquered (microtexturized)	white or black	27.561 DKK		21.594 DKK
		taupe	TRMEDTXAH 28.137 DKK	TRMEDTXH	21.899 DKK
	HPL Soft Touch by Fenix with MDF	black	TRMEDHPLAHN 39.392 DKK	TRMEDHPLH	31.239 DKK
HPL with MDF	white	TRMEDHPLAHB 39.392 DKK	TRMEDHPLH	31.239 DKK	
stained (oak): matt oak, cognac, ash, bleached oak or walnut	stained	matt oak	33.993 DKK		28.027 DKK
		cognac, ash, bleached oak or walnut	TRMDROAH 35.086 DKK	TRMDROH	28.756 DKK
lacquered microtexturized (beech): white, black or taupe	lacquered (microtexturized)	white or black	34.620 DKK		28.645 DKK
		taupe	TRMDTXAH 35.197 DKK	TRMDTXH	28.959 DKK
	HPL Soft Touch by Fenix with MDF	black	TRMDHPLAHN 46.112 DKK	TRMDHPLHN	37.960 DKK
	HPL with MDF	white	TRMDHPLAHB 46.112 DKK	TRMDHPLHB	37.960 DKK

90 cm: 119 kg
 (x2) 199x108x8 cm (0.17 m³)
 (x2) 119x18x9 cm (0.02 m³)
 (x3) 91x29x85cm (0.22 m³)

120 cm: 163 kg
 (x2) 199x139x28 cm (0.22 m³)
 (x2) 119x18x9 cm (0.02 m³)
 (x3) 91x29x85cm (0.22 m³)

+ 177€



It is possible to add a built-in wire management system (TRPMR) in a leg for an extra of 177€. It has to be indicated in the order with its reference. To see the position options for the wire management leg, see page 467.

NOTES:
 Due to the fact that the wood used is natural, the finish may vary.

All of the weights are calculated considering the option of the wooden leg.

Suggested maximum number of seats per table, calculated with an Aleta chair. The number of seats may vary depending on the chair model.

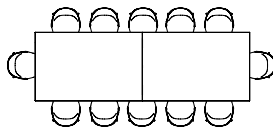

Triple table

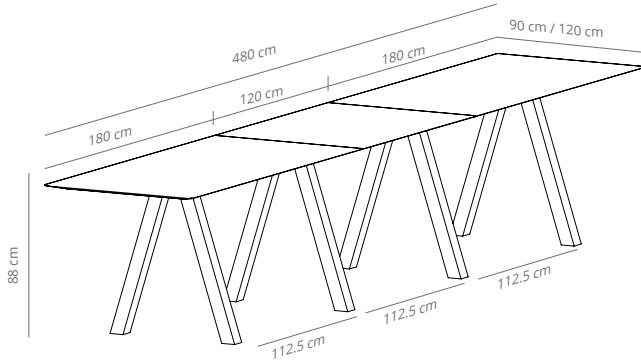

FINISHES			CODE	PUBLIC PRICE	CODE	PUBLIC PRICE	
LEGS	TOP		WIDTH 120		WIDTH 90		
metal: black or white	stained	matt oak	VCBTRMTAH	36.739 DKK	T	28.756 DKK	
		cognac, ash, bleached oak or walnut		TRMETROAH		38.146 DKK	TRMETROH
	lacquered (microtexturized)	white or black		37.680 DKK		29.637 DKK	
		taupe		TRMETTXAH		38.409 DKK	TRMETTXH
	HPL Soft Touch by Fenix with MDF	black		TRMETHPLAHN51.553 DKK		TRMETHPLHN40.926 DKK	
	HPL with MDF	white		TRMETHPLAHB51.553 DKK		TRMETHPLHB40.926 DKK	
stained (oak): matt oak, cognac, ash, bleached oak or walnut	stained	matt oak	46.129 DKK	38.146 DKK			
		cognac, ash, bleached oak or walnut	TRMTROAH	47.587 DKK	TRMTROH	39.180 DKK	
lacquered microtexturized (beech): white, black or taupe	lacquered (microtexturized)	white or black	47.070 DKK	39.027 DKK			
		taupe	TRMTTXAH	47.799 DKK	TRMTTXH	39.443 DKK	
	HPL Soft Touch by Fenix with MDF	black	TRMTHPLAHN 60.545 DKK	TRMTHPLHN 49.875 DKK			
	HPL with MDF	white	TRMTHPLAHB 60.545 DKK	TRMTHPLHB 49.875 DKK			

90 cm: 160 kg
 (x1) 138x108x8cm (0.12 m³)
 (x2) 199x108x8cm (0.17 m³)
 (x3) 119x18x9 cm (0.02 m³)
 (x4) 91x29x85cm (0.22 m³)

120 cm: 217.7 kg
 (x1) 143x139x8 cm (0.22 m³)
 (x2) 199x139x8 cm (0.22 m³)
 (x3) 119x18x9 cm (0.02 m³)
 (x4) 91x29x85cm (0.22 m³)

+ 177€



It is possible to add a built-in wire management system (TRPMR) in a leg for an extra of 177€. It has to be indicated in the order with its reference. To see the position options for the wire management leg, see page 467.

NOTES:
 The manufacturing lead time for 480 cm table tops (triples) is 2 weeks additional to the normal manufacturing lead time.

Due to the natural wood used, the finish may vary.

All weights are calculated considering the wooden legs.

Suggested maximum number of seats per table, calculated with an Aleta chair. The number of seats may vary depending on the chair model.

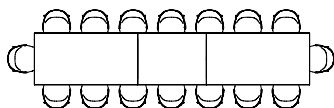

TABLES

HEIGHT 105 cm

Table 200 cm

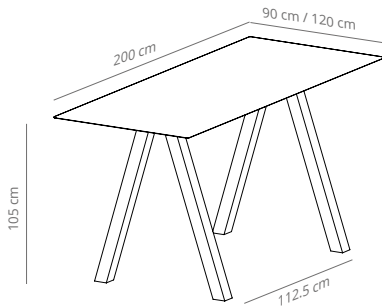

FINISHES			CODE	PUBLIC PRICE	CODE	PUBLIC PRICE		
LEGS	TOP		WIDTH 120		WIDTH 90			
metal: black or white	stained	matt oak	VCBTRMSCAB	16.348 DKK	VC	13.128 DKK		
		cognac, ash, bleached oak or walnut		TRMESCROAB		18.484 DKK	TRMESCROB	14.221 DKK
	lacquered (microtexturized)	white or black		16.348 DKK		13.128 DKK		
		taupe		16.662 DKK		13.450 DKK		
	HPL Soft Touch by Fenix with MDF	black		TRMESCHPLAB		17.094 DKK	TRMESCHPLB	14.577 DKK
	HPL with MDF	white		TRMESCHPLAB		17.094 DKK	TRMESCHPLB	14.577 DKK
stained (oak): matt oak, cognac, ash, bleached oak or walnut	stained	matt oak	23.984 DKK	19.518 DKK				
		cognac, ash, bleached oak or walnut	TRMESCROAB	24.916 DKK	TRMESCROB	20.289 DKK		
lacquered microtexturized (beech): white, black or taupe	lacquered (microtexturized)	white or black	24.391 DKK	19.882 DKK				
		taupe	24.916 DKK	20.289 DKK				
	HPL Soft Touch by Fenix with MDF	black	TRMSCHPLABN	24.018 DKK	TRMSCHPLBN	21.501 DKK		
	HPL with MDF	white	TRMSCHPLABB	24.018 DKK	TRMSCHPLBB	21.501 DKK		

90 cm: 75.4 kg
 (x1) 218x108x8cm (0.19 m³)
 (x1) 119x18x9cm (0.02 m³)
 (x2) 107.5x29x95cm (0.3 m³)

120 cm: 100.4 kg
 (x1) 218x139x8 cm (0.24 m³)
 (x1) 119x18x9cm (0.02 m³)
 (x2) 107.5x29x95cm (0.3 m³)

+ 177€



It is possible to add a built-in wire management system (TRPMR) in a leg for an extra of 177€. It has to be indicated in the order with its reference. To see the position options for the wire management leg, see page 467.

NOTES:
 Due to the fact that the wood used is natural, the finish may vary.

All of the weights are calculated considering the option of the wooden leg.

Suggested maximum number of seats per table, calculated with an Aleta chair. The number of seats may vary depending on the chair model.

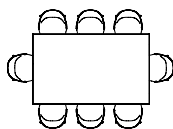

Trestle

2014, BY JOHN PAWSON

TABLES

Table 240 cm

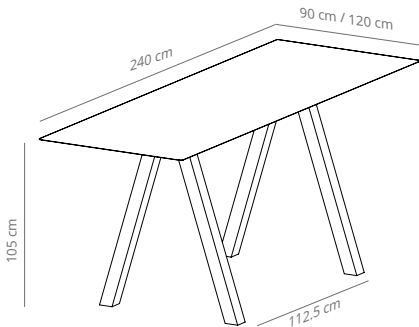

FINISHES			CODE	PUBLIC PRICE	CODE	PUBLIC PRICE	
LEGS	TOP		WIDTH 120		WIDTH 90		
metal: black or white	stained	matt oak	TRMESROAB	18.484 DKK	TRMESROB	14.221 DKK	
		cognac, ash, bleached oak or walnut		20.662 DKK		15.314 DKK	
	lacquered (microtexturized)	white or black	TRMESTXAB	18.484 DKK	TRMESTXB	14.221 DKK	
		taupe		18.891 DKK		14.484 DKK	
	HPL Soft Touch by Fenix with MDF	black	TRMESHPLABN	18.882 DKK	TRMESHPLBN	15.569 DKK	
	HPL with MDF	white	TRMESHPLABB	18.882 DKK	TRMESHPLBB	15.569 DKK	
	stained (oak): matt oak, cognac, ash, bleached oak or walnut	stained	matt oak	TRMSROAB	27.239 DKK	TRMSROB	20.289 DKK
			cognac, ash, bleached oak or walnut		28.281 DKK		21.171 DKK
		lacquered (microtexturized)	white or black	TRMSTXAB	27.713 DKK	TRMSTXB	20.755 DKK
			taupe		28.281 DKK		21.171 DKK
HPL Soft Touch by Fenix with MDF		black	TRMSHPLABN	25.806 DKK	TRMSHPLBN	22.493 DKK	
		white	TRMSHPLABB	25.806 DKK	TRMSHPLBB	22.493 DKK	

- 90 cm: 82.1 kg
 (x1) 258x108x8cm (0.19 m³)
 (x1) 119x18x9cm (0.02 m³)
 (x2) 107.5x29x95cm (0.3 m³)
- 120 cm: 139.4 kg
 (x1) 267x148x28 cm (0.24 m³)
 (x1) 119x18x9cm (0.02 m³)
 (x2) 107.5x29x95cm (0.3 m³)

+ 177€



It is possible to add a built-in wire management system (TRPMR) in a leg for an extra of 177€. It has to be indicated in the order with its reference. To see the position options for the wire management leg, see page 467.

NOTES:
 Due to the fact that the wood used is natural, the finish may vary.

All of the weights are calculated considering the option of the wooden leg.

Suggested maximum number of seats per table, calculated with an Aleta chair. The number of seats may vary depending on the chair model.

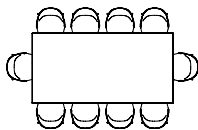

TABLES

Double table

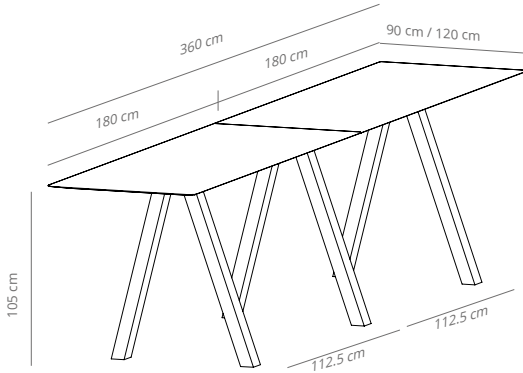

FINISHES			CODE	PUBLIC PRICE	CODE	PUBLIC PRICE		
LEGS	TOP		WIDTH 120		WIDTH 90			
metal: black or white	stained	matt oak	VCBTRMDAB	27.239 DKK	VC	21.281 DKK		
		cognac, ash, bleached oak or walnut		TRMEDROAB		28.340 DKK	TRMEDROB	22.001 DKK
	lacquered (microtexturized)	white or black		27.925 DKK		21.899 DKK		
		taupe		TRMEDTXAB		28.442 DKK	TRMEDTXB	22.213 DKK
	HPL Soft Touch by Fenix with MDF	black		TRMEDHPLABN		39.688 DKK	TRMEDHPLB	31.586 DKK
	HPL with MDF	white		TRMEDHPLABB		39.688 DKK	TRMEDHPLBB	31.586 DKK
stained (oak): matt oak, cognac, ash, bleached oak or walnut	stained	matt oak	38.146 DKK	32.171 DKK				
		cognac, ash, bleached oak or walnut	TRMDROAB	39.239 DKK	TRMDROB	32.908 DKK		
lacquered microtexturized (beech): white, black or taupe	lacquered (microtexturized)	white or black	38.816 DKK	32.798 DKK				
		taupe	TRMDTXAB	39.341 DKK	TRMDTXB	33.163 DKK		
	HPL Soft Touch by Fenix with MDF	black	TRMDHPLABN	50.121 DKK	TRMDHPLBN	41.968 DKK		
	HPL with MDF	white	TRMDHPLABB	50.121 DKK	TRMDHPLBB	41.968 DKK		

90 cm: 132.2 kg
 (x2) 199x108x8 cm (0.17 m³)
 (x2) 119x18x9 cm (0.02 m³)
 (x3) 107.5x29x95cm (0.3 m³)

120 cm: 176.2 kg
 (x2) 199x139x28 cm (0.22 m³)
 (x2) 119x18x9 cm (0.02 m³)
 (x3) 107.5x29x95cm (0.3 m³)

+ 177€



It is possible to add a built-in wire management system (TRPMR) in a leg for an extra of 177€. It has to be indicated in the order with its reference. To see the position options for the wire management leg, see page 467.

NOTES:
 Due to the fact that the wood used is natural, the finish may vary.

All of the weights are calculated considering the option of the wooden leg.

Suggested maximum number of seats per table, calculated with an Aleta chair. The number of seats may vary depending on the chair model.

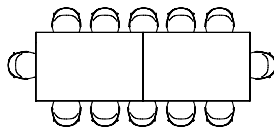

Trestle

2014, BY JOHN PAWSON

TABLES

Triple table

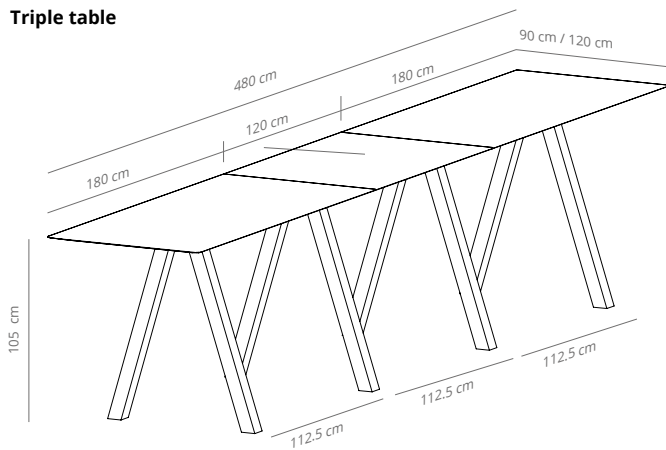

FINISHES			CODE	PUBLIC PRICE	CODE	PUBLIC PRICE		
LEGS	TOP		WIDTH 120		WIDTH 90			
metal: black or white	stained	matt oak	VCBTRMTAB	37.163 DKK	T	29.171 DKK		
		cognac, ash, bleached oak or walnut		TRMETROAB		38.604 DKK	TRMETROB	30.205 DKK
	lacquered (microtexturized)	white or black		TRMETTXAB		38.095 DKK	TRMETTXB	30.052 DKK
		taupe		38.816 DKK		30.468 DKK		
	HPL Soft Touch by Fenix with MDF	black		TRMETHPLABN5		1.994 DKK	TRMETHPLBN	41.316 DKK
	HPL with MDF	white		TRMETHPLABB5		1.994 DKK	TRMETHPLBB	41.316 DKK
stained (oak): matt oak, cognac, ash, bleached oak or walnut	stained	matt oak	51.689 DKK	43.748 DKK				
		cognac, ash, bleached oak or walnut	TRMTROAB	53.138 DKK	TRMTROB	44.740 DKK		
	lacquered (microtexturized)	white or black	52.672 DKK	44.587 DKK				
		taupe	53.350 DKK	44.994 DKK				
	HPL Soft Touch by Fenix with MDF	black	TRMTHPLABN	65.834 DKK	TRMTHPLBN	55.215 DKK		
		white	TRMTHPLABB	65.834 DKK	TRMTHPLBB	55.215 DKK		

90 cm: 177.6 kg
 (x1) 138x108x8cm (0.12 m³)
 (x2) 199x108x8cm (0.17 m³)
 (x3) 119x18x9 cm (0.02 m³)
 (x4) 107.5x29x95cm (0.3 m³)

120 cm: 235.3 kg
 (x1) 143x139x8 cm (0.22 m³)
 (x2) 199x139x8 cm (0.22 m³)
 (x3) 119x18x9 cm (0.02 m³)
 (x4) 107.5x29x95cm (0.3 m³)

+ 177€



It is possible to add a built-in wire management system (TRPMR) in a leg for an extra of 177€. It has to be indicated in the order with its reference. To see the position options for the wire management leg, see page 467.

NOTES:
 The manufacturing lead time for 480 cm table tops (triples) is 2 weeks additional to the normal manufacturing lead time.

Due to the natural wood used, the finish may vary.

All weights are calculated considering the wooden legs.

Suggested maximum number of seats per table, calculated with an Aleta chair. The number of seats may vary depending on the chair model.

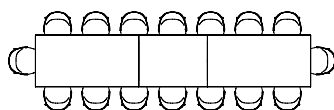

COMPONENTS FOR TABLE COMPOSITIONS

Apart from those suggested, there is a possibility to create your own table compositions.

For those compositions, it will be necessary to choose two end table tops, central table tops according to the length of the table, and the legs (the number of legs will be the result of the number of total table tops plus 1).

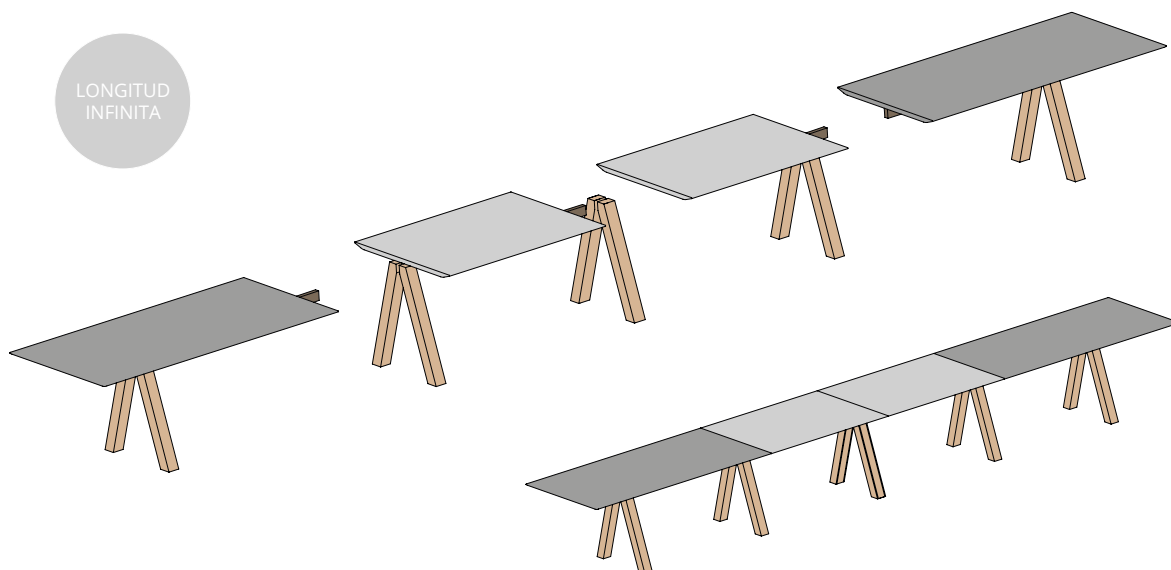

- Colour code:
- Central top (TRMC - TRMCA)
 - End top (TRME - TRMEA)
 - Legs (TRPM - TRPMH - TRPMB - TRPME - TRPMEH - TRPMEB) *

**The measure for metal legs and wooden legs is slightly different.*

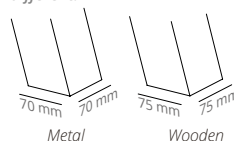

LEG OPTIONS

74 cm

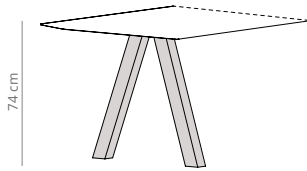

TRPME: 8.2 kg
 (x1) 29x77x75 cm (0.17 m³)

TRPM: 10 kg
 (x1) 29x77x75 cm (0.17 m³)

CODE		FINISHES		PUBLIC PRICE
VCBTRPM	TRPME	metal: black or white	white or black	2.704 DKK
	TRPM	stained (oak)	matt oak, cognac, ash, bleached oak or walnut	4.610 DKK
lacquered (beech)		white, black or taupe		

88 cm

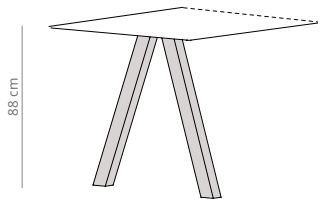

TRPMEH: 9.1 kg
 (x1) 29x91x85 cm (0.22 m³)

TRPMH: 10.6 kg
 (x1) 29x91x85 cm (0.22 m³)

CODE		FINISHES		PUBLIC PRICE
VCBTRPMH	TRPMEH	metal: black or white	white or black	2.814 DKK
	TRPMH	stained (oak)	matt oak, cognac, ash, bleached oak or walnut	5.144 DKK
lacquered (beech)		white, black or taupe		

105 cm

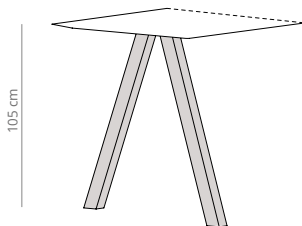

TRPMEB: 10.5 kg
 (x1) 29x107.5x95 cm (0.3 m³)

TRPMB: 14.4 kg
 (x1) 29x107.5x95 cm (0.3 m³)

CODE		FINISHES		PUBLIC PRICE
VCBTRPMB	TRPMEB	metal: black or white	white or black	2.907 DKK
	TRPMB	stained (oak)	matt oak, cognac, ash, bleached oak or walnut	6.543 DKK
lacquered (beech)		white, black or taupe		

TABLES

OPCIONES DE TABLERO

Central top

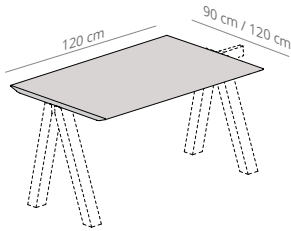

- 90 cm: 31.2 kg
 (x1) 139x108x8 cm (0.12 m³)
 (x1) 119x18x9cm (0.02 m³)
- 120 cm: 44.1 kg
 (x1) 139x143x8cm (0.16 m³)
 (x1) 119x18x9cm (0.02 m³)

FINISHES		CODE	PUBLIC PRICE	CODE	PUBLIC PRICE
stained	matt oak	TRMCARO	7.009 DKK	TRMCRO	5.034 DKK
	cognac, ash, bleached oak or walnut		7.373 DKK		5.297 DKK
lacquered (microtexturized)	white or black	TREMCAIX	7.314 DKK	TREMCTX	5.238 DKK
	taupe		7.466 DKK		5.348 DKK
HPL Soft Touch by Fenix with MDF	black	TREMCAPLN	9.534 DKK	TREMCPLN	7.017 DKK
HPL with MDF	white	TREMCAPLB	9.534 DKK	TREMCPLB	7.017 DKK

End top

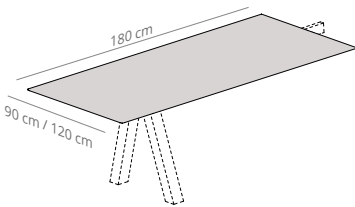

- 90 cm: 43.5 kg
 (x1) 199x108x8cm (0.19 m³)
 (x1) 119x18x9cm (0.02 m³)
- 120 cm: 65.9 kg
 (x1) 199x139x8cm (0.22 m³)
 (x1) 119x18x9cm (0.02 m³)

FINISHES		CODE	PUBLIC PRICE	CODE	PUBLIC PRICE
stained	matt oak	TRMEARO	9.289 DKK	TRMERO	6.331 DKK
	cognac, ash, bleached oak or walnut		9.865 DKK		6.687 DKK
lacquered (microtexturized)	white or black	TREMEXTX	9.602 DKK	TREMEXTX	6.644 DKK
	taupe		9.916 DKK		6.797 DKK
HPL Soft Touch by Fenix with MDF	black	TREMEAPLN	15.713 DKK	TREMEPLN	11.662 DKK
HPL with MDF	white	TREMEAPLB	15.713 DKK	TREMEPLB	11.662 DKK

NOTE: Due to the fact that the wood used is natural, the finish may vary.

WIRE MANAGEMENT

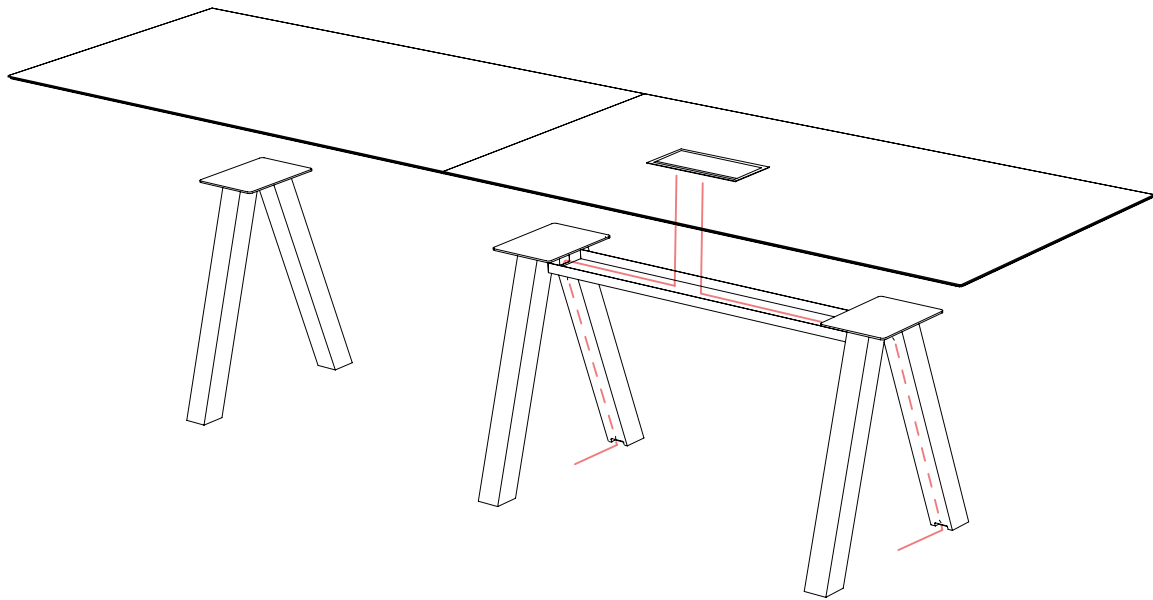

Trestle table allows the possibility of managing the wiring so it is kept hidden and integrated in the table. We offer the option of installing the wire holder (TRECAN) and the wire management leg (TRPMR).

The wire holder allows to pass the wires from the bottom of the table top to the leg and the wire management leg allows to canalize up to 6 wires until reaching the floor.



Metal leg wire management



Wooden leg wire management

Wire management leg

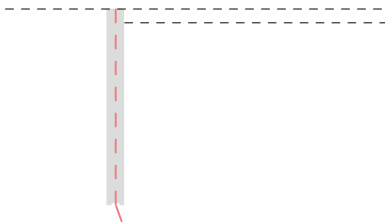

CODE		FINISHES		PUBLIC PRICE
-	TRPMR	metal: black or white	white or black	1.500 DKK
		stained (oak)	matt oak, cognac, ash, bleached oak or walnut	
		lacquered (beech)	white, black or taupe	

Wire holder

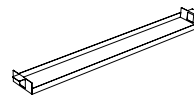

3.5 kg
(x1) 8.5x19x130 cm (0.02 m³)

CODE		FINISHES	PUBLIC PRICE
-	TRECAN	graphite grey	670 DKK

WIRE MANAGEMENT LEG SUGGESTIONS

Below are some options for the position of the wire management leg of the Trestle table. For options other than those shown, contact the sales department.

All options are valid for both 90 cm and 120 cm wide tables.

SIMPLE TABLE

PR1

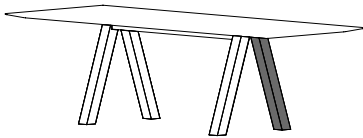

PL1

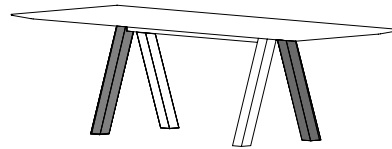

DOUBLE TABLE

PR2

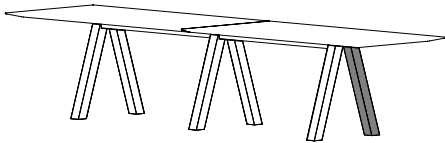

PL2

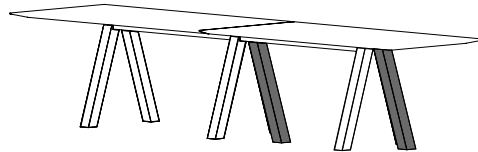

TRIPLE TABLE

PR3

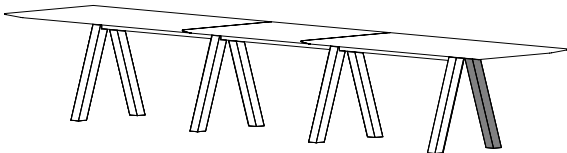

PL3

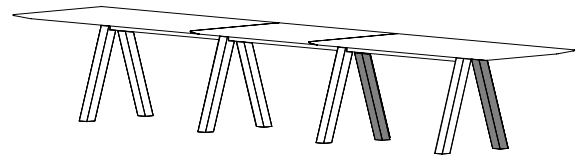

PCL3

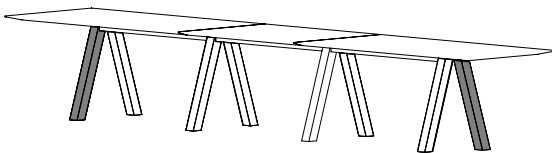

PCR3

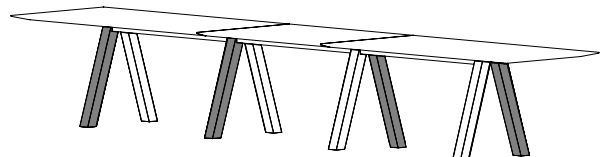

ACCESSORIES AND POWER OPTIONS

For the different table tops, we offer the possibility of installing the following accessories. The drawings with the location of the accessories different from the ones shown need the approval of the technical department.

Wire hole

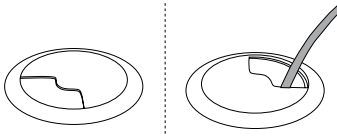

 Installed and included in the table top box

CODE		FINISHES	PUBLIC PRICE
-	AC03B	white	153 DKK

Cut out of the board is included.
Dimensions: Ø 6 cm

Cut out

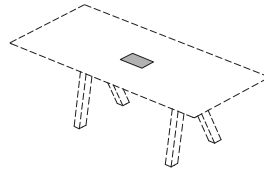

CODE		PUBLIC PRICE
-	TRMEC	1.093 DKK

Table top custom cut out. Price cut out table.

Table top protector in ecoleather

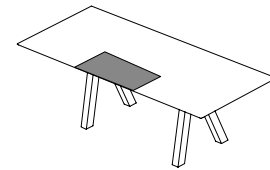

 1 kg

 Installed and included in the table top box

CODE		FINISHES	PUBLIC PRICE
-	TRPROT	eco leather	2.187 DKK

Dimensions: 44x90 cm

Table top hatch



 1.2 kg

 (x1) 34x18x9cm (0.005 m³)

CODE		FINISHES	PUBLIC PRICE
-	CAP	black, white or grey	1.246 DKK

Metallic hatch access to the lower part of the table.

Available in white, black or grey.
Does not include power options.

Dimensions: 32x15 cm

* Cut out not included.

Table top hatch plus



 1.2 kg

 (x1) 34x18x9cm (0.005 m³)

CODE		FINISHES	PUBLIC PRICE
-	CAPP	black or grey	1.500 DKK

Metallic hatch access to the lower part of the table for wooden table tops. Metal frame available in black or grey and central part in the veneer of the finish of the table. Does not include power options.

Dimensions: 32x15 cm

* Cut out not included.

USB hub

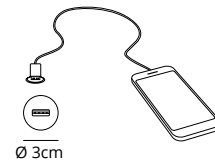

Ø 3cm

 Installed and included in the table top box

CODE		FINISHES	PUBLIC PRICE
-	TREUSB	white	525 DKK

Built-in USB hub for charging electronic devices.

Available in black or white.

Dimensions: Ø 3 cm

TABLES

Table top hatch powerbox



1.4 kg
(x1) 33x17x7.5 cm (0.005 m³)

CODE		FINISHES	PUBLIC PRICE
-	BOX-E	black, white or grey	2.441 DKK
-	BOX-M		3.534 DKK

BOX-E: 4 sockets

BOX-M: 4 devices (sockets and multimedia)

Metallic hatch with 4 sockets or combined with built-in multimedia devices.

Available in white, black or grey

Dimensions: 32x15 cm

* Cut out not included.

For all available power options [see page 505](#).

Each hatch has 4 modules (sockets or multimedia devices) to install power options. The modules can be complete (1) or half module. (1/2).

The power options are under the UNE-EN 50085 standards.

Table top hatch powerbox plus

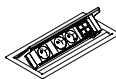

1.4 kg
(x1) 33x17x7.5 cm (0.005 m³)

CODE		FINISHES	PUBLIC PRICE
-	BOXP-E*	black or grey	3.534 DKK
-	BOXP-M*		4.610 DKK

BOXP-E: 4 sockets

BOXP-M: 4 devices (sockets and multimedia)

Metallic hatch for wooden table tops with 4 sockets or combined with built-in multimedia devices. Metal frame available in black or grey and central part in the veneer of the finish of the table.

Dimensions: 32x15 cm

* Cut out not included.

For all available power options [see page 505](#).

For the references BOX-E, BOX-M, BOXP-E, BOXP-M y TREEL-E the cable length is 0.3 meters with Wieland connector. The power connection cable is not included, and will have to be provided by the customer.

Under table powerbox

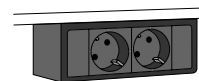

1.7 kg
(x1) 17x18x9cm (0.005 m³)

CODE		FINISHES	PUBLIC PRICE
-	TREEL-E	black	2.814 DKK

Powerbox available with 2 sockets or combined with built-in multimedia devices

For all available power options [see page 505](#).

NOTE: Not available for compact table tops.

USB hub with battery

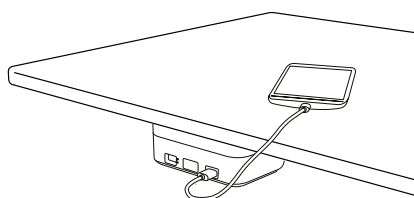

1.4 kg
(x1) 40x20x25cm (0.02 m³)

CODE		FINISHES	PUBLIC PRICE
-	TREEL-B	black	2.187 DKK

USB hub with two USB device charging ports without being plugged into electric current.

It's needed to buy the battery charging tray to charge the USB hub battery.

Battery charging tray

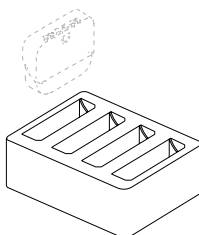

1 kg
(x1) 40x20x25cm (0.02 m³)

CODE		FINISHES	PUBLIC PRICE
-	TREEL-C	black	2.542 DKK

Battery charging tray. Charges up to four stations simultaneously in 7 hours. Includes magnetic key to remove the station from its support.

POWER POSITION SUGGESTIONS

We have curated a selection of cut out positions from the most demanded due to its polyvalence and flexibility. Please contact our sales team in case you need a quote for specials, we are open to listen to your needs. For other options, please contact the sales team, indicating the cut out reference in the order.

All the cut outs presented have the measure of a standard power box (32x15cm), compatible with the references CAP, CAPP, BOX-E, BOX-M, BOXP-E and BOXP-M.

All cut out options are valid for both 90 cm and 120 cm tables.

SIMPLE TABLE

200 A

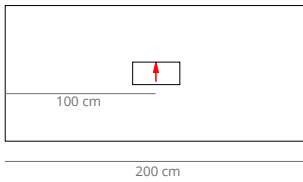

200 B

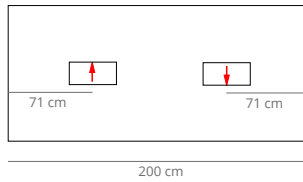

200 C

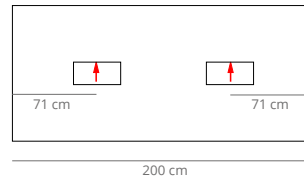

240 A

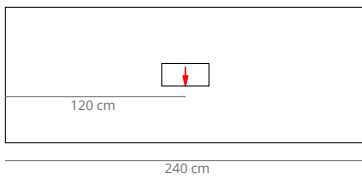

240 B

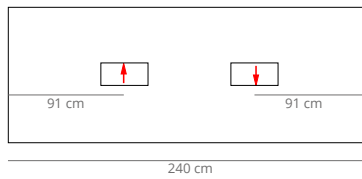

240 C

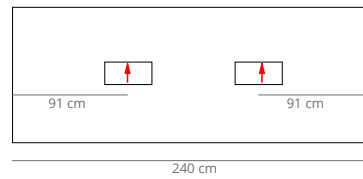

240 D



DOUBLE TABLE

360 A

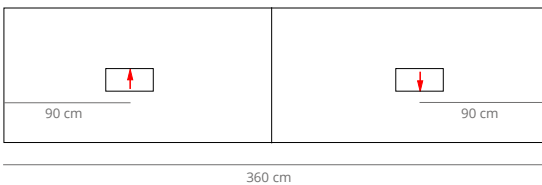

360 B

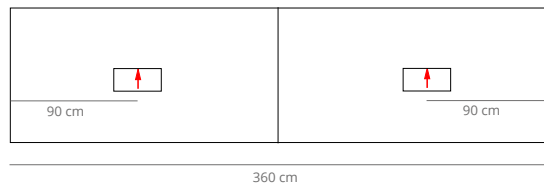

NOTE: ↑ The arrow points out the opening side

TABLES

TRIPLE TABLES

480 A

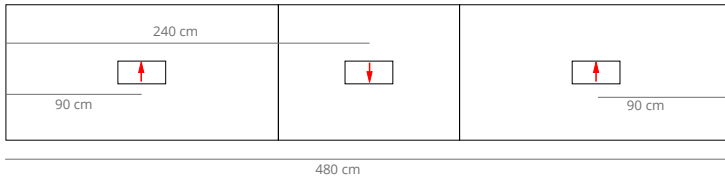

480 B

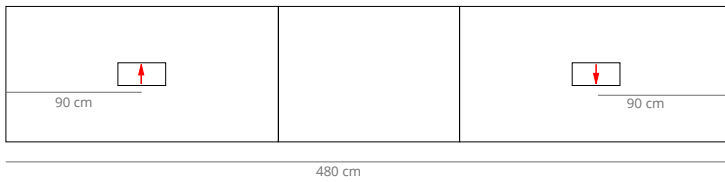

480 C

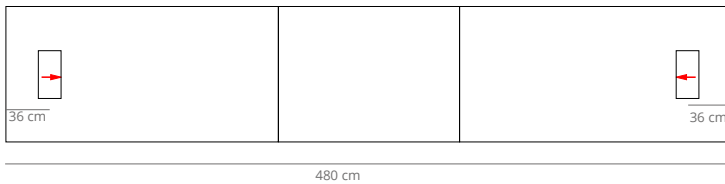

CUSTOM POSITIONS FOR POWER OPTIONS

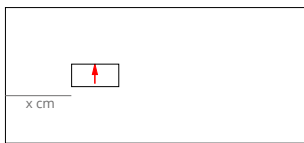

If the desired position for the power option is not among the suggested, please contact with sales department for assesstment.

Note:  The arrow points out the opening side



Stan

BY STUDIO VCCB

TABLES

Base in powder coated steel in thermoreinforced polyester in white (RAL 9016), grey (RAL7004) or black (RAL9005). The white base of the Stan table is in RAL 9016.

Different base sizes available.

The prices are quoted including the appropriate table top for the correct stability.

Table top available in different measures, materials and thickness:

- Melamine (LPL) thickness 19 mm with 1,5 mm PVC edge, in black or white.

- 12 mm thick compact laminated table top. The edge can be in black or white. With a black edge, the surface of the tabletop can be black or white; for a white edge, it can be white.

*The term of manufacture of the Stan tables is 6 weeks.

NOTE: The height of the table varies according to the thickness of the different table tops. The height indicated below refers to the base without tabletop.

Thickness and type of table top edges available for each material:

More table top information on page 21

Melamine | HPL*



Compact



Table 60x60

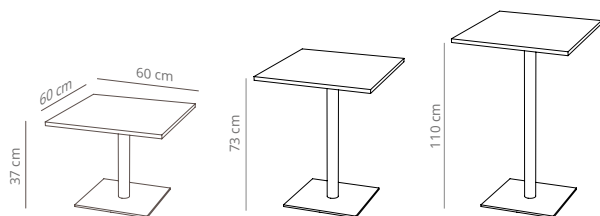

37 cm 26.2 kg
 (x1) 75x75x7.5 cm (0.08 m³)
 (x1) 50x42x50 cm (0.10 m³)

73 cm 27.2 kg
 (x1) 75x75x7.5 cm (0.08 m³)
 (x1) 50x42x75.5 cm (0.15 m³)

110 cm 25.7 kg
 (x1) 75x75x7.5 cm (0.18 m³)
 (x1) 50x42x114.5 cm (0.24 m³)

Suggested maximum number of seats per table, calculated with an Aleta chair. The number of seats may vary depending on the chair model.

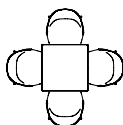

CODE	FINISHES			PUBLIC PRICE
	BASE	TOP		
HEIGHT 37	white or black	melamine	white or black	4.051 DKK
		compact laminate (black edge)	white or black	4.610 DKK
		HPL*	white or black	6.526 DKK
		compact laminate (white edge)	white	6.848 DKK
HEIGHT 72	white or black	melamine	white or black	4.305 DKK
		compact laminate (black edge)	white or black	4.721 DKK
		HPL*	white or black	6.627 DKK
		compact laminate (white edge)	white	6.958 DKK
HEIGHT 110	white or black	melamine	white or black	4.348 DKK
		compact laminate (black edge)	white or black	4.780 DKK
		HPL*	white or black	6.721 DKK
		compact laminate (white edge)	white	7.060 DKK

*Last order entry for HPL is 18 December 2023







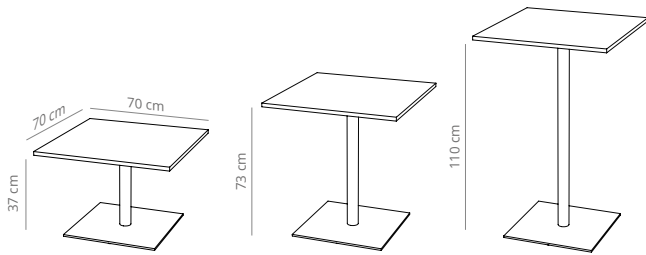

Stan

2015, BY STUDIO VCCB

TABLES

Table 70x70



- 37 cm  28.7 kg
 (x1) 91.5x93.5x12.5cm (0.10 m³)
 (x1) 60x52x50 cm (0.15 m³)
- 73 cm  29.7 kg
 (x1) 91.5x93.5x12.5cm (0.10 m³)
 (x1) 60x52x75.5cm (0.23 m³)
- 110 cm  30.7 kg
 (x1) 91.5x93.5x12.5cm (0.10 m³)
 (x1) 60x52x114.5cm (0.35 m³)

Suggested maximum number of seats per table, calculated with an Aleta chair. The number of seats may vary depending on the chair model.

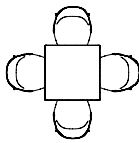







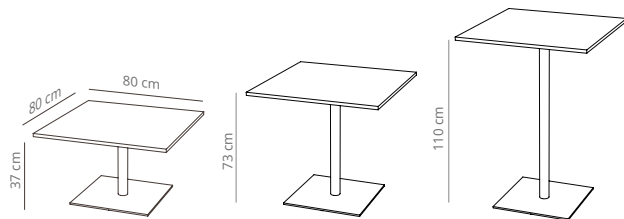

	CODE	FINISHES		PUBLIC PRICE	
		BASE	TOP		
HEIGHT 37	ST37C70M	white or black	melamine	white or black	4.593 DKK
	ST37C70CN		compact laminate (black edge)	white or black	5.399 DKK
	ST37C70HPL		HPL*	white or black	7.865 DKK
	ST37C70CB		compact laminate (white edge)	white	8.255 DKK
HEIGHT 72	ST72C70M	white or black	melamine	white or black	4.653 DKK
	ST72C70CN		compact laminate (black edge)	white or black	5.449 DKK
	ST72C70HPL		HPL*	white or black	7.907 DKK
	ST72C70CB		compact laminate (white edge)	white	8.305 DKK
HEIGHT 110	ST110C70M	white or black	melamine	white or black	4.738 DKK
	ST110C70CN		compact laminate (black edge)	white or black	5.560 DKK
	ST110C70HPL		HPL*	white or black	8.009 DKK
	ST110C70CB		compact laminate (white edge)	white	8.416 DKK

*Last order entry for HPL is 18 December 2023

Table 80x80



- 37 cm  30.3kg
 (x1) 101.5x103.5x12.5cm (0.13 m³)
 (x1) 60x52x50cm (0.15 m³)
- 73 cm  31.3 kg
 (x1) 101.5x103.5x12.5cm (0.13 m³)
 (x1) 60x52x75.5cm (0.23 m³)
- 110 cm  32.3 kg
 (x1) 101.5x103.5x12.5cm (0.13 m³)
 (x1) 60x52x114.5cm (0.35 m³)

Suggested maximum number of seats per table, calculated with an Aleta chair. The number of seats may vary depending on the chair model.

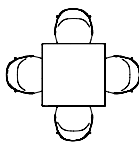

	CODE	FINISHES		PUBLIC PRICE	
		BASE	TOP		
HEIGHT 37	ST37C80M	white or black	melamine	white or black	4.695 DKK
	ST37C80CN		compact laminate (black edge)	white or black	5.856 DKK
	ST37C80HPL		HPL*	white or black	7.907 DKK
	ST37C80CB		compact laminate (white edge)	white	8.305 DKK
HEIGHT 72	ST72C80M	white or black	melamine	white or black	4.738 DKK
	ST72C80CN		compact laminate (black edge)	white or black	5.924 DKK
	ST72C80HPL		HPL*	white or black	8.009 DKK
	ST72C80CB		compact laminate (white edge)	white	8.416 DKK
HEIGHT 110	ST110C80M	white or black	melamine	white or black	4.839 DKK
	ST110C80CN		compact laminate (black edge)	white or black	6.026 DKK
	ST110C80HPL		HPL*	white or black	8.051 DKK
	ST110C80CB		compact laminate (white edge)	white	8.458 DKK

*Last order entry for HPL is 18 December 2023

TABLES

Table 90x90

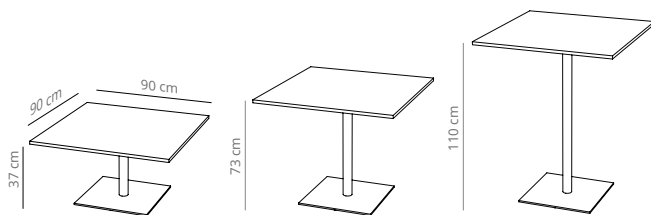

- 37 cm 31.7kg
 (x1) 111.5x113.5x12.5cm (0.15 m³)
 (x1) 60x52x50cm (0.15 m³)
- 73 cm 32.7 kg
 (x1) 111.5x113.5x12.5cm (0.15 m³)
 (x1) 60x52x75.5cm (0.23 m³)
- 110 cm 33.7 kg
 (x1) 111.5x113.5x12.5cm (0.15 m³)
 (x1) 60x52x114.5cm (0.35 m³)

Suggested maximum number of seats per table, calculated with an Aleta chair. The number of seats may vary depending on the chair model.

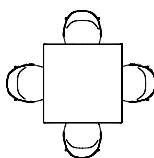

	CODE	FINISHES		PUBLIC PRICE	
		BASE	TOP		
HEIGHT 37	ST37C90M	white or black	melamine	white or black	4.738 DKK
	ST37C90CN		compact laminate (black edge)	white or black	6.543 DKK
	ST37C90HPL		HPL*	white or black	9.594 DKK
	ST37C90CB		compact laminate (white edge)	white	10.077 DKK
HEIGHT 72	ST72C90M	white or black	melamine	white or black	4.797 DKK
	ST72C90CN		compact laminate (black edge)	white or black	6.594 DKK
	ST72C90HPL		HPL*	white or black	9.687 DKK
	ST72C90CB		compact laminate (white edge)	white	10.170 DKK
HEIGHT 110	ST110C90M	white or black	melamine	white or black	4.899 DKK
	ST110C90CN		compact laminate (black edge)	white or black	6.687 DKK
	ST110C90HPL		HPL*	white or black	9.738 DKK
	ST110C90CB		compact laminate (white edge)	white	10.221 DKK

*Last order entry for HPL is 18 December 2023

Table diameter 60

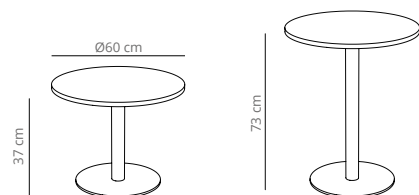

- 37 cm 26.2 kg
 (x1) 81.5x83.5x12.5cm (0.08 m³)
 (x1) 50x42x50cm (0.10 m³)
- 73 cm 27.2 kg
 (x1) 81.5x83.5x12.5cm (0.08 m³)
 (x1) 50x42x75.5cm (0.15 m³)

Suggested maximum number of seats per table, calculated with an Aleta chair. The number of seats may vary depending on the chair model.

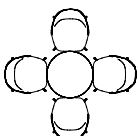

	CODE	FINISHES		PUBLIC PRICE	
		BASE	TOP		
HEIGHT 37	ST37D60M	white or black	melamine	white or black	4.941 DKK
	ST37D60CN		compact laminate (black edge)	white or black	5.449 DKK
	ST37D60HPL		HPL*	white or black	6.526 DKK
	ST37D60CB		compact laminate (white edge)	white	6.848 DKK
HEIGHT 72	ST72D60M	white or black	melamine	white or black	4.992 DKK
	ST72D60CN		compact laminate (black edge)	white or black	5.509 DKK
	ST72D60HPL		HPL*	white or black	6.627 DKK
	ST72D60CB		compact laminate (white edge)	white	6.958 DKK

*Last order entry for HPL is 18 December 2023







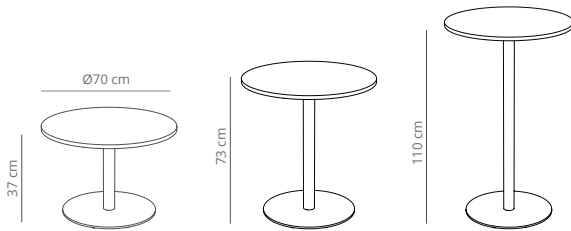

Stan

2015, BY STUDIO VCCB

TABLES

Table diameter 70



- 37 cm  28.7kg
 (x1) 91.5x93.5x12.5cm (0.10 m³)
 (x1) 60x52x50cm (0.15 m³)
- 73 cm  29.7 kg
 (x1) 91.5x93.5x12.5cm (0.10 m³)
 (x1) 60x52x75.5cm (0.23 m³)
- 110 cm  30.7 kg
 (x1) 91.5x93.5x12.5cm (0.10 m³)
 (x1) 60x52x114.5cm (0.35 m³)

Suggested maximum number of seats per table, calculated with an Aleta chair. The number of seats may vary depending on the chair model.

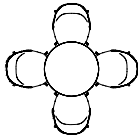
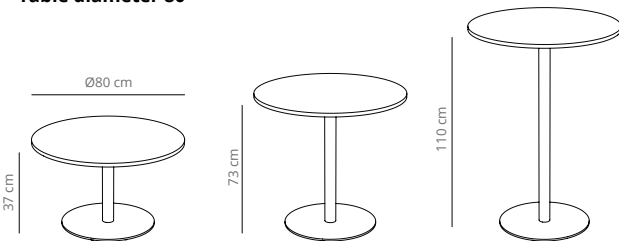









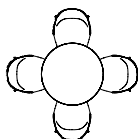

Table diameter 80



- 37 cm  30.3kg
 (x1) 101.5x103.5x12.5cm (0.13 m³)
 (x1) 60x52x50cm (0.15 m³)
- 73 cm  31.3kg
 (x1) 101.5x103.5x12.5cm (0.13 m³)
 (x1) 60x52x75.5cm (0.23 m³)
- 110 cm  32.3 kg
 (x1) 101.5x103.5x12.5cm (0.13 m³)
 (x1) 60x52x114.5cm (0.35 m³)

Suggested maximum number of seats per table, calculated with an Aleta chair. The number of seats may vary depending on the chair model.



	CODE	FINISHES		PUBLIC PRICE	
		BASE	TOP		
HEIGHT 37	ST37D70M	white or black	melamine	white or black	5.288 DKK
	ST37D70CN		compact laminate (black edge)	white or black	5.653 DKK
	ST37D70HPL		HPL*	white or black	7.805 DKK
	ST37D70CB		compact laminate (white edge)	white	8.204 DKK
HEIGHT 72	ST72D70M	white or black	melamine	white or black	5.339 DKK
	ST72D70CN		compact laminate (black edge)	white or black	6.331 DKK
	ST72D70HPL		HPL*	white or black	7.865 DKK
	ST72D70CB		compact laminate (white edge)	white	8.255 DKK
HEIGHT 110	ST110D70M	white or black	melamine	white or black	5.441 DKK
	ST110D70CN		compact laminate (black edge)	white or black	6.390 DKK
	ST110D70HPL		HPL*	white or black	7.958 DKK
	ST110D70CB		compact laminate (white edge)	white	8.356 DKK

*Last order entry for HPL is 18 December 2023

	CODE	FINISHES		PUBLIC PRICE	
		BASE	TOP		
HEIGHT 37	ST37D80M	white or black	melamine	white or black	5.390 DKK
	ST37D80CN		compact laminate (black edge)	white or black	5.814 DKK
	ST37D80HPL		HPL*	white or black	7.865 DKK
	ST37D80CB		compact laminate (white edge)	white	8.255 DKK
HEIGHT 72	ST72D80M	white or black	melamine	white or black	5.441 DKK
	ST72D80CN		compact laminate (black edge)	white or black	5.856 DKK
	ST72D80HPL		HPL*	white or black	7.958 DKK
	ST72D80CB		compact laminate (white edge)	white	8.356 DKK
HEIGHT 110	ST110D80M	white or black	melamine	white or black	5.534 DKK
	ST110D80CN		compact laminate (black edge)	white or black	5.966 DKK
	ST110D80HPL		HPL*	white or black	8.009 DKK
	ST110D80CB		compact laminate (white edge)	white	8.416 DKK

*Last order entry for HPL is 18 December 2023

TABLES

Table diameter 90

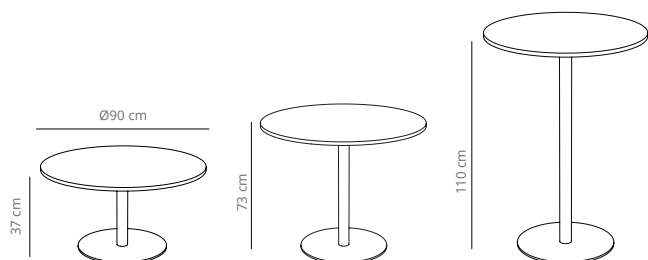

- 37 cm 31.7kg
 (x1) 111.5x113.5x12.5cm (0.15 m³)
 (x1) 60x52x50cm (0.15 m³)
- 73 cm 32.7 kg
 (x1) 111.5x113.5x12.5cm (0.15 m³)
 (x1) 60x52x75.5cm (0.23 m³)
- 110 cm 33.7 kg
 (x1) 111.5x113.5x12.5cm (0.15 m³)
 (x1) 60x52x114.5cm (0.35 m³)

Suggested maximum number of seats per table, calculated with an Aleta chair. The number of seats may vary depending on the chair model.

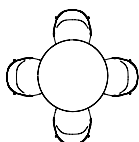
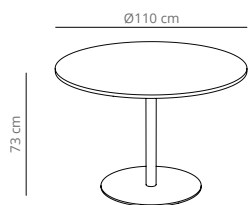
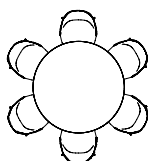

Table diameter 110



- 40.8 kg
 (x1) 131.5x143.5x12.5cm (0.23 m³)
 (x1) 70x62x75.5cm (0.32 m³)

Suggested maximum number of seats per table, calculated with an Aleta chair. The number of seats may vary depending on the chair model.



	CODE	FINISHES		PUBLIC PRICE	
		BASE	TOP		
HEIGHT 37	ST37D90M	white or black	melamine	white or black	5.483 DKK
	ST37D90CN		compact laminate (black edge)	white or black	6.483 DKK
	ST37D90HPL		HPL*	white or black	9.534 DKK
	ST37D90CB		compact laminate (white edge)	white	10.017 DKK
HEIGHT 72	ST72D90M	white or black	melamine	white or black	5.534 DKK
	ST72D90CN		compact laminate (black edge)	white or black	6.543 DKK
	ST72D90HPL		HPL*	white or black	9.594 DKK
	ST72D90CB		compact laminate (white edge)	white	10.077 DKK
HEIGHT 110	ST110D90M	white or black	melamine	white or black	5.636 DKK
	ST110D90CN		compact laminate (black edge)	white or black	6.644 DKK
	ST110D90HPL		HPL*	white or black	9.687 DKK
	ST110D90CB		compact laminate (white edge)	white	10.170 DKK

*Last order entry for HPL is 18 December 2023

CODE	FINISHES		PUBLIC PRICE	
	BASE	TOP		
ST72D110M	white or black	melamine	white or black	6.221 DKK
ST72D110CN		compact laminate (black edge)	white or black	8.255 DKK
ST72D110HPL		HPL*	white or black	12.153 DKK
ST72D110CB		compact laminate (white edge)	white	12.772 DKK

*Last order entry for HPL is 18 December 2023

Stan

2015, BY STUDIO VCCB

TABLES

Table diameter 140

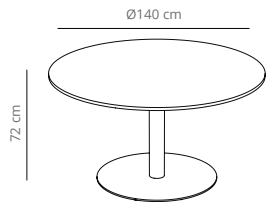

47.4 kg

(x1) 141.5x133.5x12.5cm (0.23 m³)
(x1) 80x72x75.5cm (0.42 m³)

Suggested maximum number of seats per table, calculated with an Aleta chair. The number of seats may vary depending on the chair model.

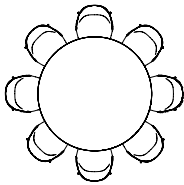

CODE	FINISHES		PUBLIC PRICE	
	BASE	TOP		
ST72D140M	white or black	melamine	white or black	10.916 DKK
ST72D140CN		compact laminate (black edge)	white or black	15.823 DKK
ST72D140CB		compact laminate (white edge)	white	21.704 DKK

*Last order entry for HPL is 18 December 2023

ACCESSORIES AND POWER OPTIONS

Linking device

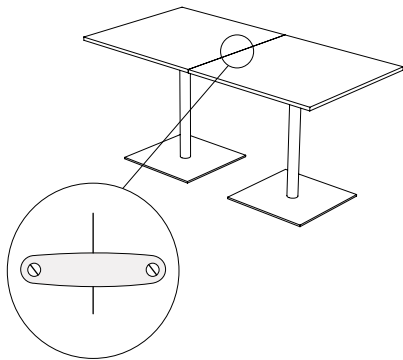

CODE	CODE
STCO	322 DKK

*Only for squared tables

USB hub with battery

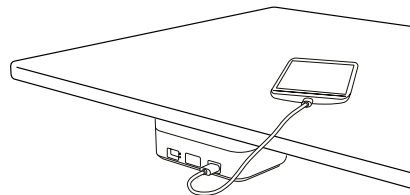

1.4 kg

(x1) 40x20x25cm (0.02 m³)

CODE	FINISHES	PUBLIC PRICE
STEL-B	black	2.187 DKK

USB hub with two USB device charging ports without being plugged into electric current. It's needed to buy the battery charging tray to charge the USB hub battery.

Battery charging tray

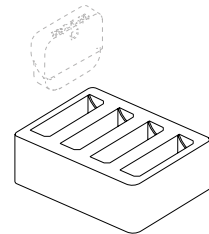

1 kg

(x1) 40x20x25cm (0.02 m³)

CODE	FINISHES	PUBLIC PRICE
STEL-C	black	2.542 DKK

Battery charging tray. Charges up to four stations simultaneously in 7 hours. Includes magnetic key to remove the station from its support.



Trino

BY ELISA OSSINO

VICCARBE · Price List 2023 EXW

V01 Apr.

LOW TABLES

The close relationship between Elisa Ossino and geometry is translated to the Viccarbe collection thanks to a new range of side tables.

Trino is born with a sculptural soul and stage vocation, with the inherent elegance of a design capable of expressing and complementing all types of interiors. The new Ossino tables are also easy to move thanks to a handle available in three different finishes: metal, solid oak and marble.

NOTE: Due to the fact that the marble and wood used is natural, the finish may vary.

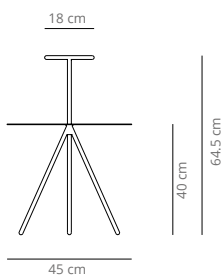
T Model

6.8 kg

(x1) 53x52x52 cm (0.14 m³)

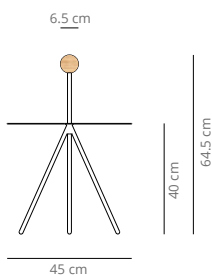
Oak sphere Model

6.7 kg

(x1) 53x52x52 cm (0.14 m³)

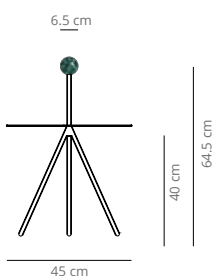
Green marble sphere Model

7.1 kg

(x1) 53x52x52 cm (0.14 m³)

Function and form meet again on this occasion to promote conversation between objects and space.

Top and base in calibrated steel structure powder coated in thermoreinforced polyester in single-color black.

Available with three different types of handle:

- T-shaped model in calibrated steel powder coated in thermoreinforced polyester.

- Solid oak sphere model stained in natural matt finish.

- Marble sphere model in Indian Green color.

CODE	FINISHES		PUBLIC PRICE
	STRUCTURE		
TRIT	black or white		2.390 DKK

CODE	FINISHES		PUBLIC PRICE
	STRUCTURE	SPHERE	
TRIRO	black or white	matt oak	2.746 DKK

CODE	FINISHES		PUBLIC PRICE
	STRUCTURE	SPHERE	
TRIM	black or white	marble	4.204 DKK



Burin Mini

BY PATRICIA URQUIOLA

LOW TABLES

Test certificates: UNE EN 15372:08
(See the test certificate list on page 448).

Structure in calibrated powder coated steel tube in thermoreinforced polyester.
Polyurethane foam base with 10 kg interior counterweight.
Handle made of high resistance technical fabric, available for all tables.
Table in MDF with single-colour lacquer finish with the finishes of our collection.

Side table height 50 / height 55

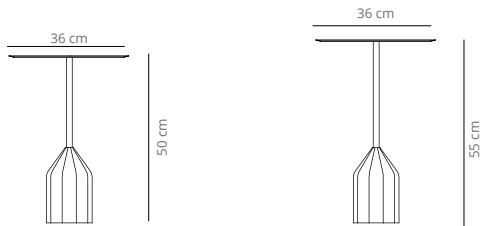

13.1 kg
 (x1) 43.5x43.5x62cm (0.12 m³)

13.1 kg
 (x1) 43.5x43.5x62cm (0.12 m³)

CODE	FINISHES		PUBLIC PRICE
	LACQUERED		
BU50	black or white*		4.051 DKK
	taupe, brick, ochre, olive green, dusty pink or dusty green		4.204 DKK
BU55	bronze		4.415 DKK

Side table height 50 with handle / height 55 with handle

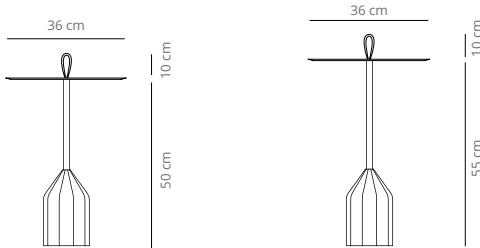

13.1 kg
 (x1) 43.5x43.5x62cm (0.12 m³)

13.1 kg
 (x1) 43.5x43.5x62cm (0.12 m³)

CODE	FINISHES		PUBLIC PRICE
	LACQUERED	HANDLE	
BU50A	black or white*	white, black, blue, green, brown or red	4.356 DKK
	taupe, brick, ochre, olive green, dusty pink or dusty green		4.568 DKK
BU55A	bronze		4.780 DKK

*The whole range of colours has a smooth lacquered finish except black, which has a lacquered microtextured finish.



Aleta

BY JAIME HAYON

LOW TABLES

Test certificates: UNE-EN 15372:2017 and ANSI/SOHO S6.5:2008 (R2013)

Calibrated steel structure with brass finish or powder coated in thermoreinforced polyester in white, black or taupe.

Table top available in different measures, materials and thickness:
 - 25 mm lacquered technical micro-texturised MDF top in all the finishes of the collection, bevelled on both sides of the top.
 - Melamine (LPL) thickness 19 mm with 1.5 mm PVC edge, in black or white.

- 12 mm thick compact laminated table top. The edge can be in black or white. With a black edge, the surface of the tabletop can be black or white; for a white edge, it can be white.

NOTE 1: The height of the table varies according to the thickness of the different table tops. The height indicated below refers to the MDF table.

Thickness and type of table top edges available for each material:



More table top information on page 23

Table H40

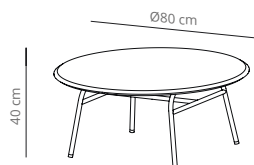

18.2 kg
 (x1) 96x96x7cm (0.07 m³)
 (x1) 64x64x60cm (0.25 m³)

CODE	FINISHES		PUBLIC PRICE	
	STRUCTURE	TOP		
ALMEBD80M	black, white or taupe	melamine	white or black	4.593 DKK
ALMEBD80TX		lacquered (microtexturized)	white or black	4.204 DKK
			taupe, brick, ochre, olive green, dusty pink and dusty green	4.314 DKK
ALMEBD80CN		compact laminate (black edge)	white or black	5.602 DKK
ALMEBD80CB		compact laminate (white edge)	white	7.526 DKK
ALMEBD80HPL		HPL*	white or black	5.636 DKK
ALMEBD80M	brass finish	melamine	white or black	5.882 DKK
ALMEBD80TX		lacquered (microtexturized)	white or black	5.449 DKK
			taupe, brick, ochre, olive green, dusty pink and dusty green	5.560 DKK
ALMEBD80CN		compact laminate (black edge)	white or black	7.212 DKK
ALMEBD80CB		compact laminate (white edge)	white	9.653 DKK
ALMEBD80HPL		HPL*	white or black	7.272 DKK

**Last order entry for HPL is 18 December 2023*

NOTE: Up to 4 tables can be packed in the same box.

POWER OPTIONS

USB hub with battery

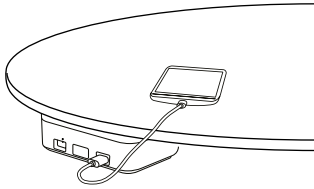

5 kg

(x1) 40x20x25cm (0.02 m³)

CODE	FINISHES	PUBLIC PRICE
ALMEEL-B	black	2.187 DKK

USB hub with two USB device charging ports without being plugged into electric current.

It's needed to buy the battery charging tray to charge the USB hub battery.

NOTE: The position is predetermined for compact table tops.

Battery charging tray

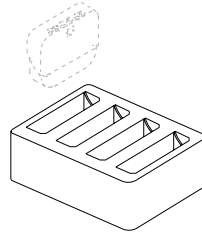

1 kg

(x1) 40x20x25cm (0.02 m³)

CODE	FINISHES	PUBLIC PRICE
ALMEEL-C	black	2.542 DKK

Battery charging tray. Charges up to four stations simultaneously in 7 hours. Includes magnetic key to remove the station from its support.



Ryutaro

BY VICTOR CARRASCO

LOW TABLES

Legs in calibrated powder coated steel tube in thermoreinforced polyester in black, white or red with transparent injection polypropylene tips. Different base and legs sizes available. Tops in MDF lacquered or oak veneer with the finishes of our collection.

NOTE: Due to the fact that the wood used is natural, the finish may vary.

Low table diameter 50

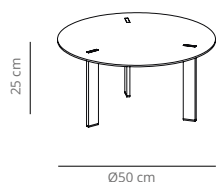

5.2 kg
 (x1) 65.5x65.5x7cm (0.03 m³)
 (x1) 40x33x11cm (0.014 m³)

Low table diameter 60

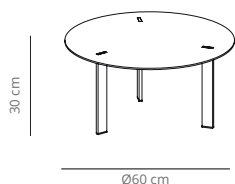

6.7 kg
 (x1) 76x76x7cm (0.04 m³)
 (x1) 40x33x11cm (0.014 m³)

Low table diameter 90*

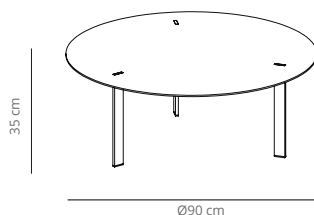

12.3 kg
 (x1) 106.5x106.5x7cm (0.08 m³)
 (x1) 40x33x11cm (0.014 m³)

CODE	FINISHES		PUBLIC PRICE	
	STRUCTURE	TOP		
RYD50H25		stained	matt oak	2.492 DKK
			cognac, ash, bleached oak or walnut	2.746 DKK
RYD50H25L	black or white	lacquered	black or white*	2.602 DKK
			taupe, brick, ochre, olive green, dusty pink or dusty green	2.746 DKK
			bronze	2.856 DKK

CODE	FINISHES		PUBLIC PRICE	
	STRUCTURE	TOP		
RYD60H30		stained	matt oak	2.814 DKK
			cognac, ash, bleached oak or walnut	3.068 DKK
RYD60H30L	black or white	lacquered	black or white*	2.958 DKK
			taupe, brick, ochre, olive green, dusty pink or dusty green	3.068 DKK
			bronze	3.170 DKK

CODE	FINISHES		PUBLIC PRICE	
	STRUCTURE	TOP		
RYD90H35		stained	matt oak	4.102 DKK
			cognac, ash, bleached oak or walnut	4.526 DKK
RYD90H35L	black or white	lacquered	black or white*	4.314 DKK
			taupe, brick, ochre, olive green, dusty pink or dusty green	4.526 DKK
			bronze	4.721 DKK

*Last order entry 18 December 2023

*The whole range of colours has a smooth lacquered finish except black, which has a lacquered microtextured finish.
 The legs have white and black lacquered. For 30 cm height leg also available in red.



Shape

BY JORGE PENSI

LOW TABLES

Test certificates: UNE EN 15372:08 (model H)

Collection of tables manufactured in MDF.
Manually satin lacquered in the colours of our collection.

Side table model H

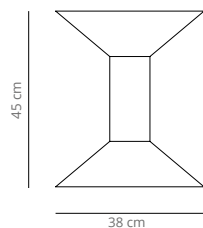

📦 15 kg

📦 (x1) 46.5x46.5x54cm (0.12 m³)

CODE	FINISHES		PUBLIC PRICE
SH-H	matt	black, white, taupe, brick, ochre, dusty pink or dusty green	5.144 DKK
		bronze or olive green	5.399 DKK
	fluorescent	fluorescent orange	6.687 DKK

Side table model O

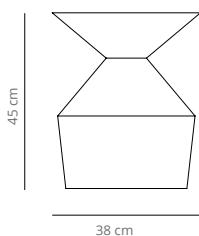

📦 15.3 kg

📦 (x1) 46.5x46.5x54cm (0.12 m³)

CODE	FINISHES		PUBLIC PRICE
SH-O	matt	black, white, taupe, brick, ochre, dusty pink or dusty green	6.331 DKK
		bronze or olive green	6.687 DKK
	fluorescent	fluorescent orange	8.416 DKK



Tiers

BY PATRICIA URQUIOLA

LOW TABLES

Structure in calibrated powder coated steel tube in thermoreinforced polyester in black or white.

Top in MDF lacquered in the finishes of our collection or veneered in matt natural oak, cognac, ash or wenge.

Transparent injection polypropylene glides.

There is the possibility of combining boards of different colors. In case of bicolor option, you must consider the superior price category.

NOTE 1: If one of the black lacquered tops is ordered, the other top will also come with a microtextured finish.

NOTE 2: Due to the fact that the wood used is natural, the finish may vary.

Low table model A

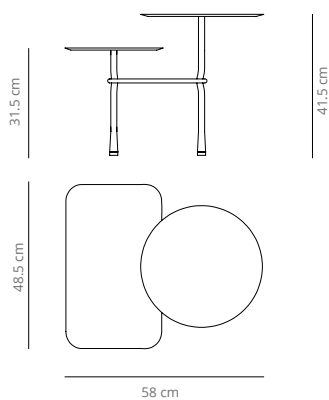

📦 7.5 kg

📦 (x1) 65x57x48cm (0.18 m³)

CODE	FINISHES		PUBLIC PRICE	
	STRUCTURE	TOP		
T1ABRO		stained	matt oak	3.992 DKK
			cognac, ash, bleached oak or walnut	4.153 DKK
T1AB	white or black	lacquered	white or black*	3.992 DKK
			taupe, brick, ochre, olive green, dusty pink or dusty green	4.153 DKK
			bronze	4.314 DKK

**The whole range of colours has a smooth lacquered finish except black, which has a lacquered microtextured finish.*



Serra

BY VICTOR CARRASCO

LOW TABLES

Test certificates: UNE EN 15372:08 (Serra rectangular) and ANSI/SOHO s6.5:2013 (serra round)
(See the test certificate list on page 448.)

Lacquered MDF or oak veneer tops in the finishes of our collection. Column in calibrated powder coated steel tube in thermoreinforced polyester in white or black. Strap or belt produced in high-resistance technical fabric in red, black and grey. There is a possibility of combining boards of different colours. In that case, you always have to consider the price of the superior category.

Height 45 without strap

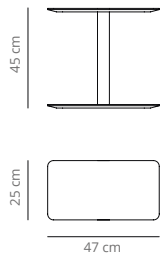

5.1 kg
(x1) 53x53x33cm (0.09 m³)

Height 45 with strap

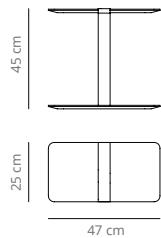

5.1 kg
(x1) (x1) 53x53x33cm (0.09 m³)

Height 50 without strap

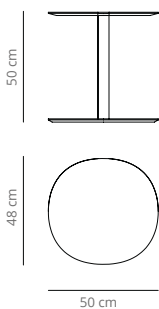

11.3 kg
(x1) 55x53.5x58cm (0.17 m³)

CODE	FINISHES		PUBLIC PRICE	
	STRUCTURE	TOP		
SE45S	white or black	stained	matt oak	2.127 DKK
			cognac, ash, bleached oak or walnut	2.280 DKK
		lacquered	black or white*	2.187 DKK
			taupe, brick, ochre, olive green, dusty pink or dusty green	2.280 DKK
			bronze	2.441 DKK

CODE	FINISHES			PUBLIC PRICE	
	STRAP	STRUCTURE	TOP		
SE45	black, grey or red	white or black	stained	matt oak	2.237 DKK
				cognac, ash, bleached oak or walnut	2.441 DKK
			lacquered	black or white*	2.280 DKK
				taupe, brick, ochre, olive green, dusty pink or dusty green	2.441 DKK
				bronze	2.704 DKK

CODE	FINISHES		PUBLIC PRICE	
	STRUCTURE	TOP		
SE50	white or black	stained	matt oak	2.746 DKK
			cognac, ash, bleached oak or walnut	3.068 DKK
		lacquered	black or white*	2.958 DKK
			taupe, brick, ochre, olive green, dusty pink or dusty green	3.068 DKK
			bronze	3.220 DKK

*The whole range of colours has a smooth lacquered finish except black, which has a lacquered microtextured finish.



Holy Day

BY JEAN-MARIE MASSAUD

LOW TABLES

Side table of oak wood stained with the finishes of our collection.
Structure in calibrated powder coated steel tube in thermoreinforced polyester in black or white.

Needed fabric for material
1.40 m: 0.75 m

NOTE: Due to the fact that the wood used is natural, the finish may vary.

Last order entry 18 December 2023

Side table diameter 50

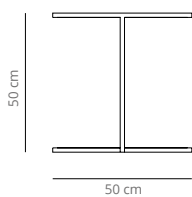
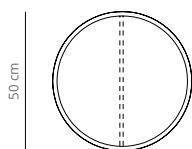

 5.6 kg

 (x1) 53x53x53cm (0.15 m³)

CODE	FINISHES		PUBLIC PRICE
HD50RO	stained	matt oak	3.848 DKK
		cognac, ash or wenge	4.102 DKK



Giro

BY PEDRO PAULO - VENZON

LOW TABLES

Stained solid oak table top in the finishes of the collection.
 Calibrated steel structure with brass finish or powder coated in
 thermoreinforced polyester in black or white.
 Plastic glides.

NOTE: Due to the fact that the wood used is natural, the finish may vary.

Sculpture table

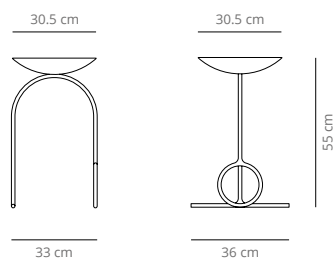

▲ 5.4 kg

📦 (x1) 44x44x62cm (0.12 m³)

CODE	FINISHES		PUBLIC PRICE	
	STRUCTURE	TOP		
GIRO	white, black	lacquered	white or black	5.297 DKK
		stained	matt oak, cognac, ash, bleched oak or walnut	5.297 DKK
	brass finish	lacquered	white or black	6.644 DKK
		stained	matt oak, cognac, ash, bleched oak or walnut	6.644 DKK



Bamba

BY PEDRO PAULO-VENZON

LOW TABLES

Table top and calibrated steel structure powder coated in thermoreinforced polyester in single-color black or white.
Plastic glides.

Sculpture table

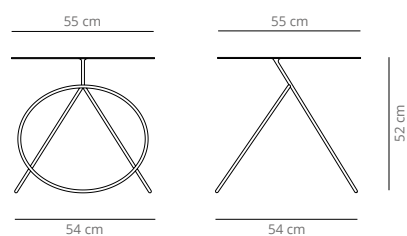

📦 14.9 kg

📦 (x1) 63x64x61 cm (0.25 m³)

CODE	FINISHES	PUBLIC PRICE
BAMBA	white or black	4.153 DKK



Up in the Air

BY RAMÓN ÚBEDA AND OTTO CANALDA

LOW TABLES

Collection tables lacquered in black or white with handmade fish replicas, floating in UV resistant silicone. Anti-reflective optical glass. As for the handcrafted process, the design might slightly change from one fish to another.

Last order entry 18 December 2023

Side table height 45

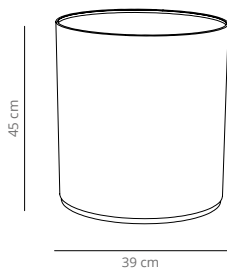

TWO FISH 'Dragon eye'



📦 24 kg

📦 (x1) 46x46x55cm (0.12 m³)

CODE	FINISHES		PUBLIC PRICE
	LACQUER	FISH	
UP45	black or white	two fish 'dragon eyes'	16.814 DKK



Window

BY VINCENT VAN DUYSSEN

ACCESSORIES

Test certificates: UNE EN 14749:06 and UNE EN 56843:2001.

Calibrated powder coated steel tube in thermoreinforced polyester in black or white microtexturized.
Rounded hangers laser cut and carefully designed dimensions for the proper care of the clothes.
Polyethylene mousse interior in black or white.

Free standing coat hanger

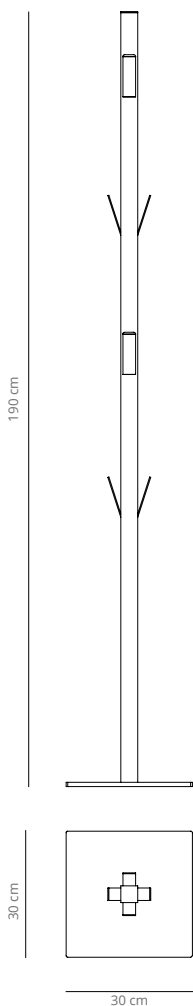

14.9 kg
(x1) 17x17x193cm (0.06 m³)
(x1) 7x38x38cm (0.01 m³)

CODE	FINISHES	PUBLIC PRICE
WIPIN	black	2.814 DKK
WIPIB	white	

Wall coat hanger

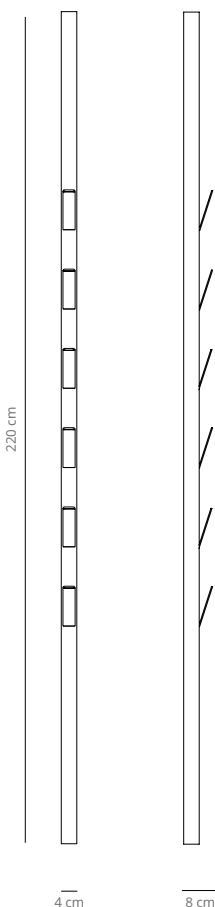

8.9 kg
(x1) 17x17x223cm (0.06 m³)

CODE	FINISHES	PUBLIC PRICE
WIPAN	black	2.026 DKK
WIPAB	white	

Umbrella stand

Powder coated steel tube in thermoreinforced epoxy in black or white.

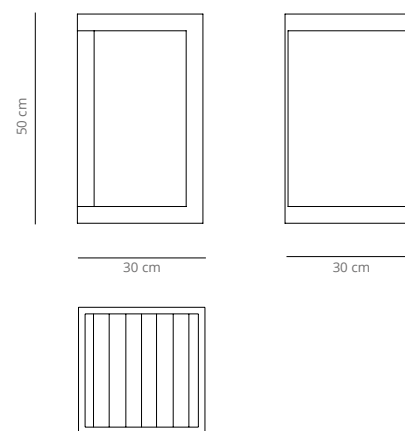

6 kg
(x1) 46.5x46.5x54.5cm (0.12 m³)

CODE	FINISHES	PUBLIC PRICE
WIPRN	black	2.814 DKK
WIPRB	white	



Keel

BY VICTOR CARRASCO

ACCESSORIES

Collection of bookshelves in stained solid oak in the collection's finishes. The infinite possibilities of its graphic compositions enable the creation of facilities for placing books, objects or photographs. Includes adjustable wall anchor system (does not include screws).

Last order entry 18 December 2023

Medium bookshelf

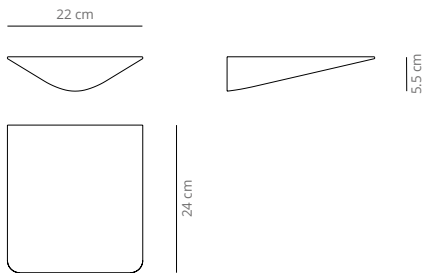

1.5 kg
 (x1) 13x50x27cm (0.02 m³)

CODE	FINISHES		PUBLIC PRICE
KEEMRO	stained	matt oak, cognac, ash, bleached oak or walnut	1.712 DKK

High bookshelf

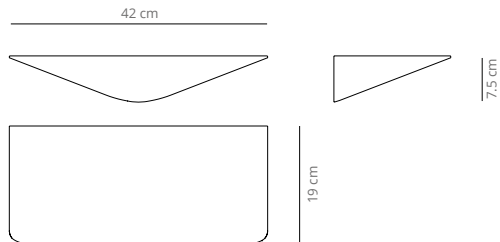

2.3 kg
 (x1) 13x50x27cm (0.02 m³)

CODE	FINISHES		PUBLIC PRICE
KEEGRO	stained	matt oak, cognac, ash, bleached oak or walnut	1.924 DKK

Certificates

BURIN MINI

The model tested complies satisfactorily with specifications of standard UNE EN 15372:08, according to the following tests:
Safety. General requirements and shear and squeeze points.
Horizontal static load.
Vertical static load.
Horizontal fatigue.
Vertical fatigue, cantilever or pedestal tables.
Vertical impact for tables without glass.

NAGI high armchair

The model tested complies satisfactorily with specifications of standards UNE EN 16139:13, according to the following tests:
General requirements for safety.
Front roll-over stability.
Rear roll-over stability.
Stability roll-over in rocking chairs.
Static on seat load.
Load static on the front edge of the seat.
Durability of the seat and backrest.
Durability of the front edge of the seat.

SERRA rectangular

The model tested complies satisfactorily with specifications of standard UNE EN 15372:08, according to the following tests:
Safety. General requirements and shear and squeeze points.
Horizontal static load.
Vertical static load.
Horizontal fatigue.
Vertical fatigue, cantilever or pedestal tables.
Vertical impact for tables without glass.

FINISHING PROCESS white (smooth)

The tested finishing system fulfils the requirements in the standards UNE 89401-1 and UNE 89401-3 to be used as a finishing system.

FINISHING PROCESS white (microtextured)













The tested finishing system fulfils the requirements in the standards UNE 89401-1, UNE 89401-2 and UNE 89401-3 to be used as a finishing system.

LAST MINUTE

The model tested complies satisfactorily with specifications of standard UNE EN 16139:13, according to the following tests:
Fatigue on the front edge of the seat.
Fatigue on seat and back.

Power Options

Socket models available.





Schuko (F) Austria, Finland, Germany, Greece, Holland, Indonesia (110/220V), Italy, Luxembourg, Norway, Portugal, Russia, Spain, Sweden, Turkey	1	
French (E) Belgium, France, Morocco, Poland, Slovakia, Tunesz	1	
Italian 10A (L) Chile, Italy, Uruguay	1	
Danish (K) Denmark	1	
Swiss 10A (J) Switzerland	1	
Swiss 16A Switzerland	1	
British (G) Bahrain, Cyprus, Kuwait, Malta, Qatar, Saudi Arabia (127/220V), Singapore, United Kingdom, United Arab Emirates	1	
American (B) Canada (120V), Colombia (110V), Costa Rica (120V), Cuba (110V), Ecuador (120V), Guatemala (120V), Japan (100V), Mexico (127V), Panama (110V), Peru, Philippines, USA (120V)	1	
Euro American Austria, Finland, Germany, Greece, Holland, Indonesia (110/220V), Italy, Luxembourg, Norway, Portugal, Russia, Spain, Sweden, Turkey	1	
Australian (I) Australia, China, New Zealand, Argentina	1	
USB Charger* USB A + USB C (20W)	1/2*	
USB Charger 847 DKK USB C (60W)	1	

For charging mobile phones and other devices

For computer charging

*The USB charger allows special configurations in the powerbox.
 For other options, please contact sales department.

Multimedia devices available:

VGA  1/2	RJ45  1/2	USB data transfer  1/2
HDMI  1/2	Minijack  1/2	

Power Options

Socket models available.

This socket options are only available for the next product references:

Trivio table
TRIELO

UK fused

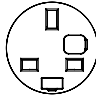

Australian

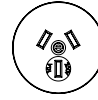

Italian

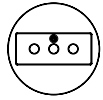

Sistema Sofa
SISCON-E

UK unfused



Chinese combi



USA Nema



Step Sofa
STECON-E

Savina Sofa
SAVICON-E
SAVIELO

Schuko



Danish



Season Sofa
SESELO

Season Bench
SEBELO

French/ Belgian



Swiss



Common Bench
COELO

Season Pouf
SEMELO

Multimedia models available.

This socket options are only available for the next product references:

Trivio Table
TRIELUC

TUF-R A+C
(25W)



For charging mobile phones and other devices

Sistema Sofa
SISCON-U

Step Sofa
STECON-U

Savina Sofa
SAVICON-U
SAVIELUC

Season Sofa
SESELUC

Season Bench
SEBELUC

Common Bench
COELUC

Season Pouf
SEMELUC

Fabrics selections

Standard Fabrics

EMEA | APAC | UK

A curated selection of fabrics available as standards, stocked in Spain, for the fastest delivery.

Now available a collection of fabrics in stock that guarantee a shorter lead time on all upholstery products and provides guidance of the best-performing ranges.

viccarbe

G1



Crevin Urus 08

G1



Crevin Duo 04

G2



Crevin Gaudi 11

G1



Crevin Duo 50

G2

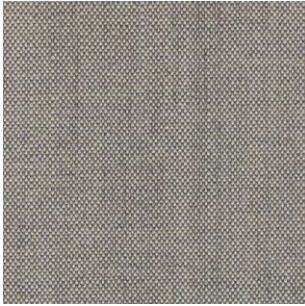

Kvadrat Remix 3 126

G1



Camira Era Promp 45

G2



Camira Main Line Flax Archway

G2



Camira Main Line Flax Camden

G2

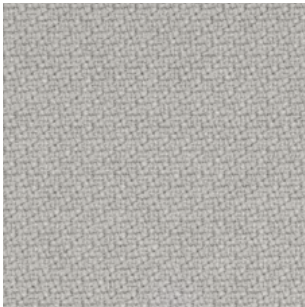

Gabriel Step 60004

G3

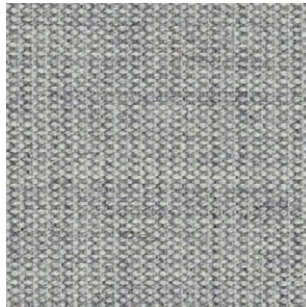

Kvadrat Canvas 2 124

G2

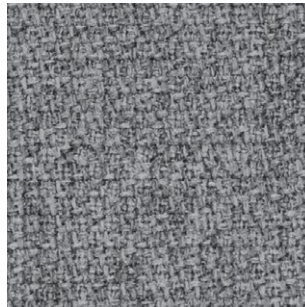

Gabriel Step Melange 60004

G5

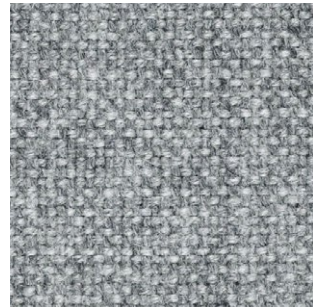

Kvadrat Hallingdal 65 130

G2

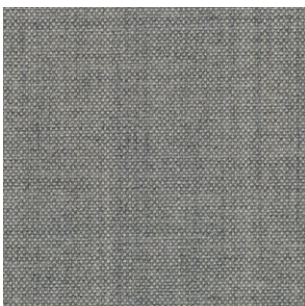

Kvadrat Remix 3 123

G2

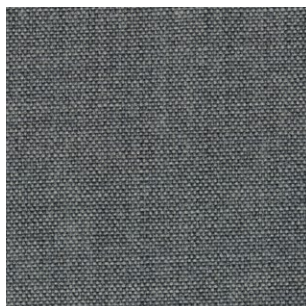

Kvadrat Remix 3 143

G5



Kvadrat Hallingdal 65 180

⚠ Not available in UK: Crevin collections Duo, Urus and Gaudi.

G2



Crevin Gaudi 05

G2



Camira Main Line Flax Upminster

G4

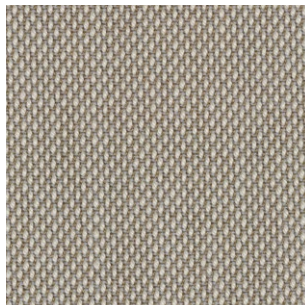

Kvadrat Steelcut Trio 213

G5



Kvadrat Divina Melange 3 237

G5



Kvadrat Hallingdal 65 220

G1

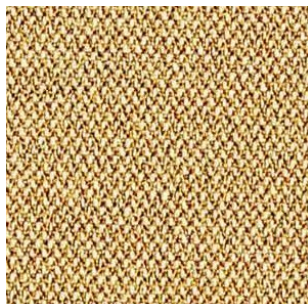

Camira Era Splitsecond 31

G4

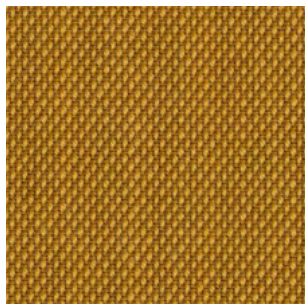

Kvadrat Steelcut Trio 3 453

G5



Kvadrat Divina Melange 3 457

G5

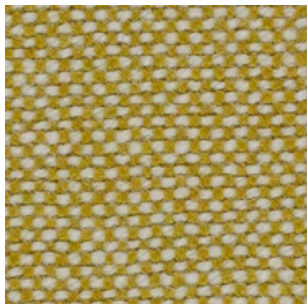

Kvadrat Hallingdal 65 407

G2

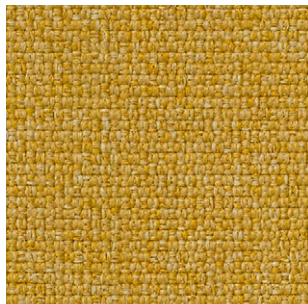

Gabriel Medley 62054

G2

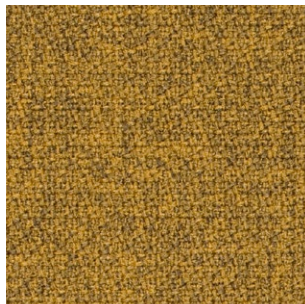

Gabriel Step Melange 62057

G2

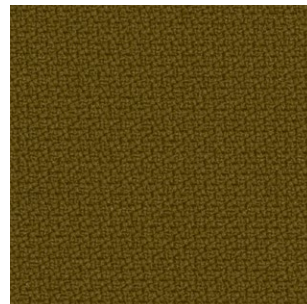

Gabriel Step 68165

G2

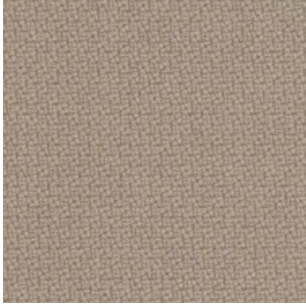

Gabriel Step 61149

G2



Gabriel Medley 61189

G2



Kvadrat Remix 3 242

G1



Gabriel Felicity 61164

G1

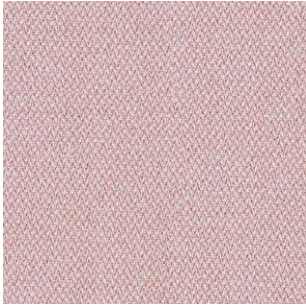

Camira Era Calendar 19

G2



Kvadrat Remix 3 612

G5

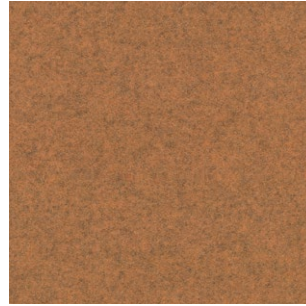

Kvadrat Divina Melange 3 527

G2



Gabriel Medley 61003

G5

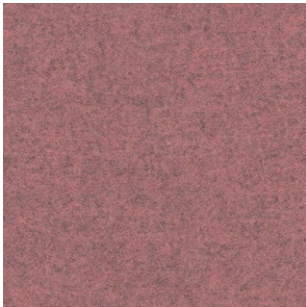

Kvadrat Divina Melange 3 617

G1

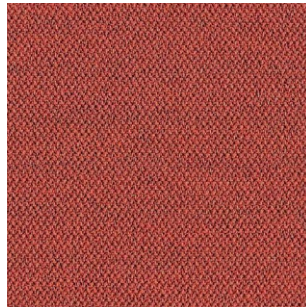

Camira Era Experience 29

G1

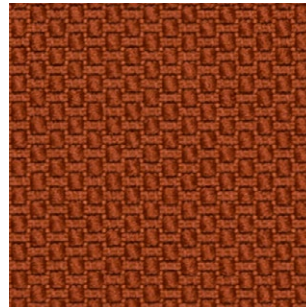

Gabriel Felicity 63089

G2

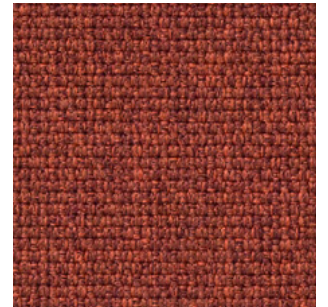

Gabriel Medley 63063

G4

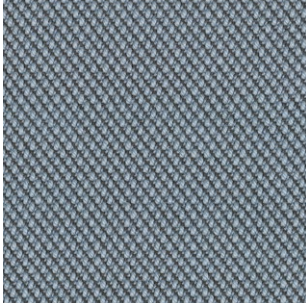

Kvadrat Steelcut Trio 3 713

G1

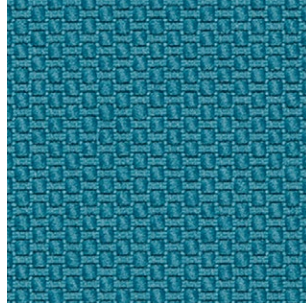

Gabriel Felicity 67079

G3

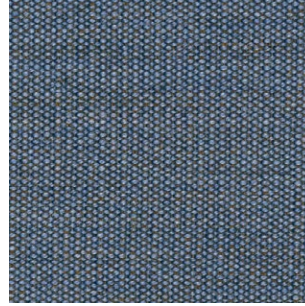

Kvadrat Canvas 2 734

G2

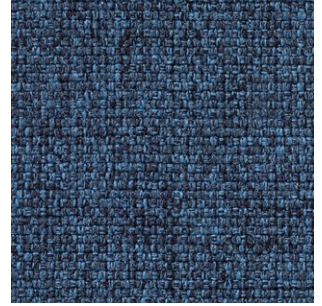

Gabriel Medley 66010

G3

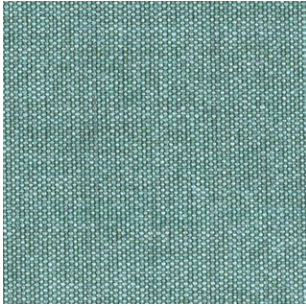

Kvadrat Canvas 2 836

G4

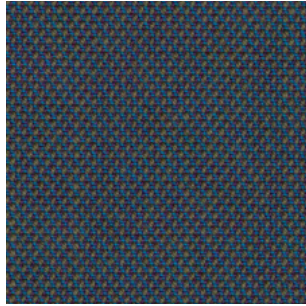

Kvadrat Steelcut Trio 3 883

G2



Gabriel Step 68158

G2



Gabriel Step Melange 68158

G2



Gabriel Step Melange 61104

G2



Camira MLF09 Monument

G3

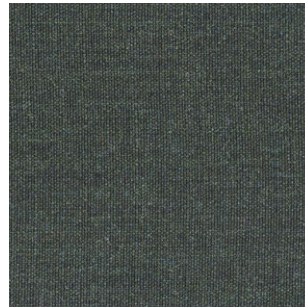

Kvadrat Canvas 2 996

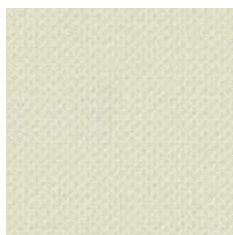

Atlantic 60061

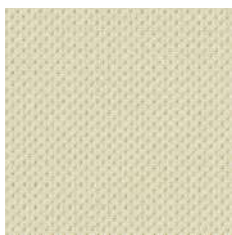

Atlantic 60063

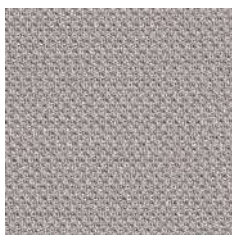

Atlantic 60141

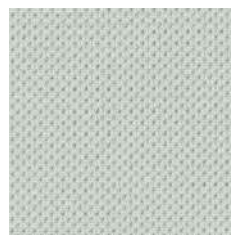

Atlantic 60095

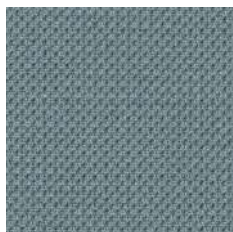

Atlantic 60334



Atlantic 60143

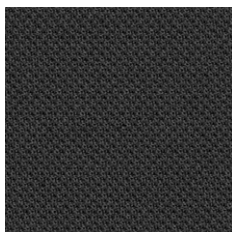

Atlantic 60025



Atlantic 60999

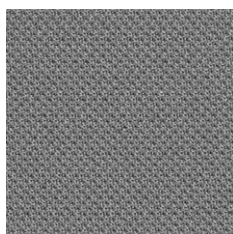

Atlantic 60011

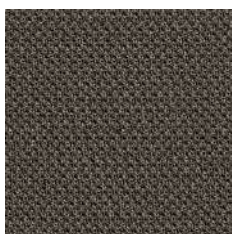

Atlantic 61163



Atlantic 60142



Atlantic 60333



Atlantic 61128

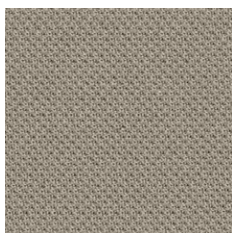

Atlantic 61078

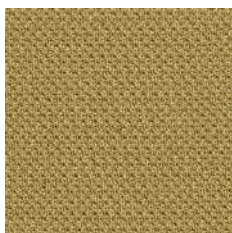

Atlantic 61166



Atlantic 61110



Atlantic 61271



Atlantic 61165



Atlantic 63127



Atlantic 63055



Atlantic 63033



Atlantic 61270



Atlantic 61272

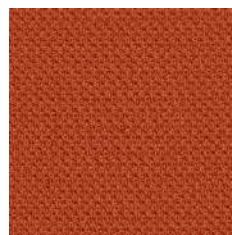

Atlantic 63034



Atlantic 63057



Atlantic 64093



Atlantic 64105

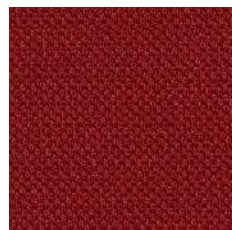

Atlantic 64089



Atlantic 64117



Atlantic 61269



Atlantic 61164

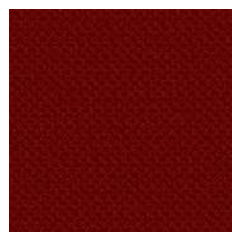

Atlantic 64092

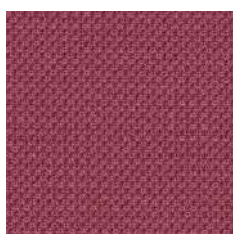

Atlantic 64255

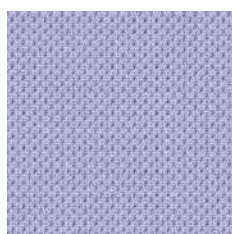

Atlantic 65142



Atlantic 65037



Atlantic 66064

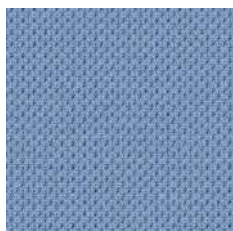

Atlantic 66095



Atlantic 66041



Atlantic 66125



Atlantic 66062



Atlantic 66249



Atlantic 66140



Atlantic 66123



Atlantic 66057



Atlantic 66250

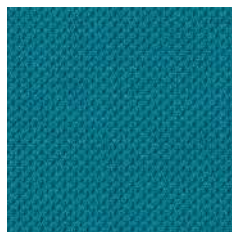

Atlantic 66086

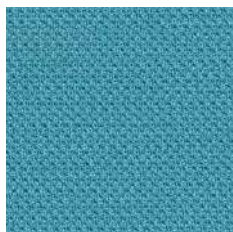

Atlantic 66063

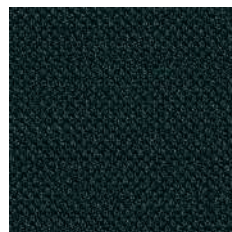

Atlantic 67043

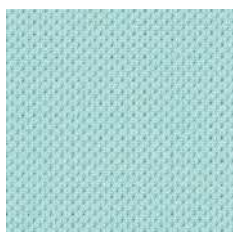

Atlantic 67128



Atlantic 67030

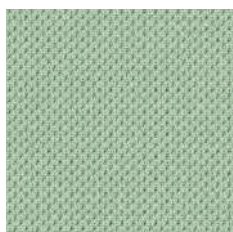

Atlantic 68275

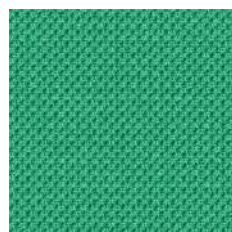

Atlantic 68276



Atlantic 68277



Atlantic 68274



Atlantic 68054



Atlantic 68110



Atlantic 62048



Beacon



Hideaway



Confine



Craven



Ralstone



Fortress



Drawbridge



Redstone



Bingham



Hold



Augusta



Stillwater



Hamilton



Abide



Resistance



Redoubt

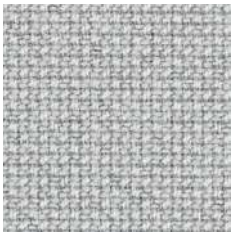

Cura 60000



Cura 61232

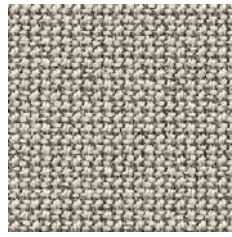

Cura 60112

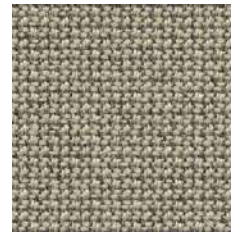

Cura 61168

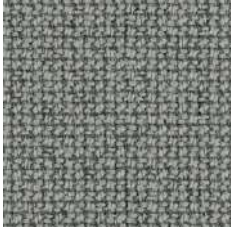

Cura 60327



Cura 62125



Cura 60109

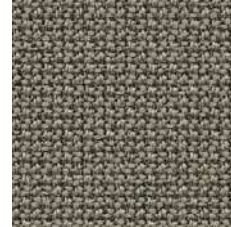

Cura 60110



Cura 61169



Cura 61259

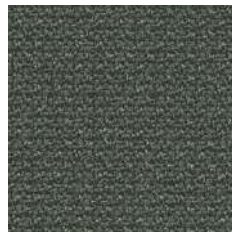

Cura 60019

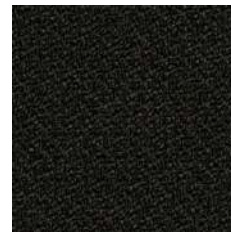

Cura 60999

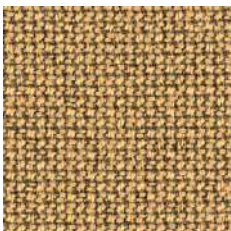

Cura 61233



Cura 62083



Cura 62084



Cura 62082



Cura 62126



Cura 61260

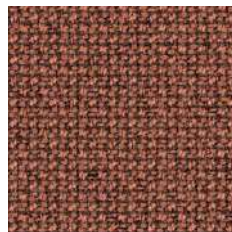

Cura 61257



Cura 63078

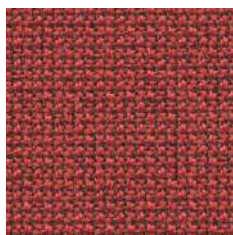

Cura 64197

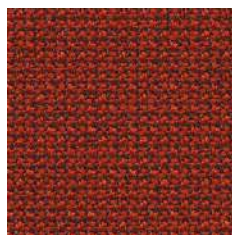

Cura 63012

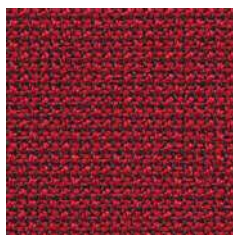

Cura 64013



Cura 64196



Cura 64240



Cura 64194

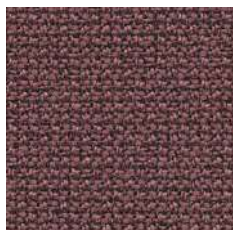

Cura 64195



Cura 64252



Cura 61258



Cura 65137

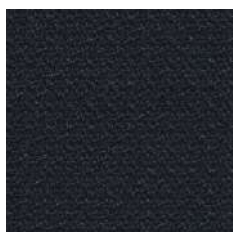

Cura 60111

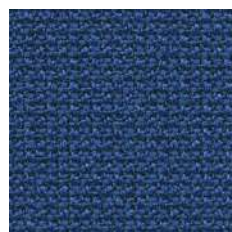

Cura 65105

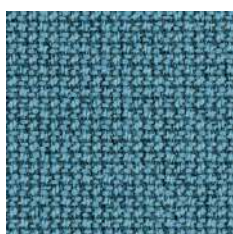

Cura 66240

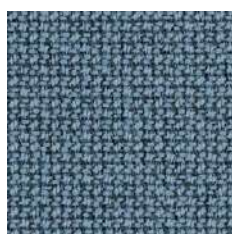

Cura 66239



Cura 66167



Cura 66165

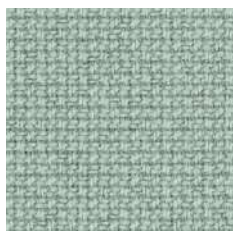

Cura 68262

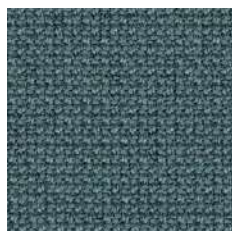

Cura 68187



Cura 66170



Cura 66169

GABRIEL CURA



Cura 68186

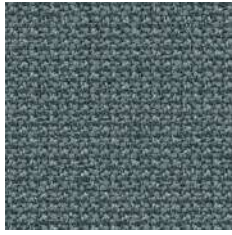

Cura 66166

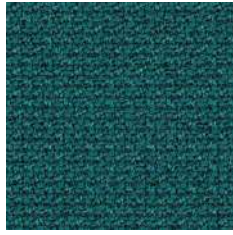

Cura 67084



Cura 68264



Cura 68181



Cura 68261

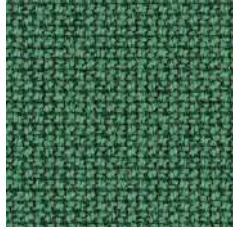

Cura 68263

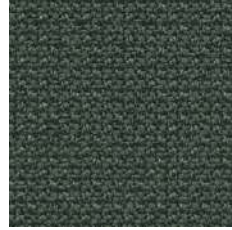

Cura 68182

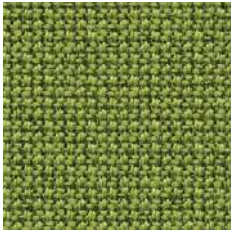

Cura 68180

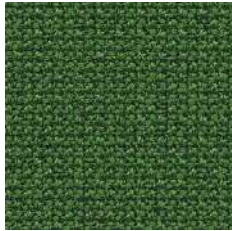

Cura 68183

CREVIN DUO



Duo 02



Duo 04

FAST TRACK



Duo 05



Duo 07

⚠ Not available in UK: Crevin collection Duo.

CREVIN DUO



Duo 16



Duo 33



Duo 40



Duo 42

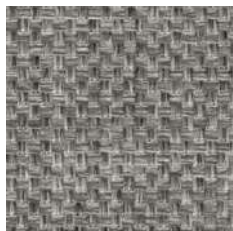

Duo 50

FAST TRACK

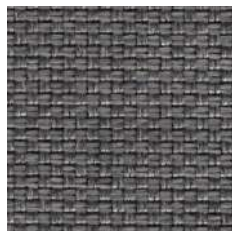

Duo 51



Duo 52



Duo 53



Duo 54



Duo 71



Duo 59

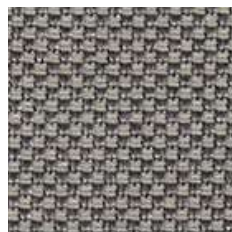

Duo 70

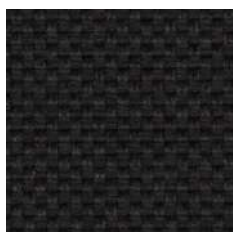

Duo 55

⚠ Not available in UK: Crevin collection Duo.

CAMIRA ERA

GROUP 1

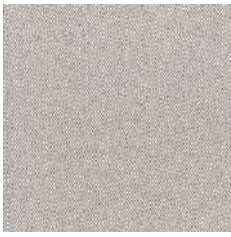

Quota



Futurist

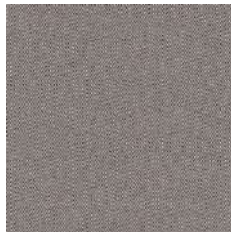

Generation

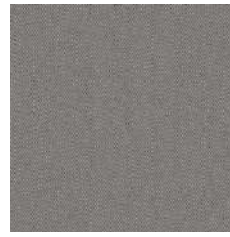

Forecast



History

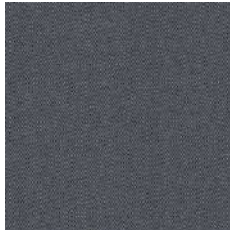

Present



Transition



Splitsecond

FASTTRACK



Occasion

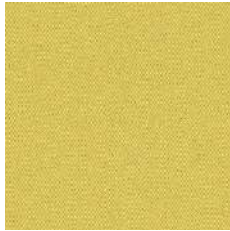

Lifetime



Sequence



Measure



Span



Turn



Experience

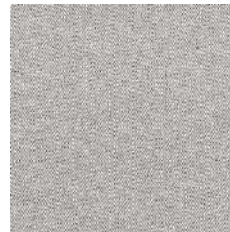

Memo

FASTTRACK



Calendar

FASTTRACK



Phase



Cycle



Extent



Date



Occurrence



Prime



Elapse

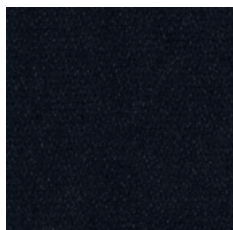

Forward



Allowance



Youth

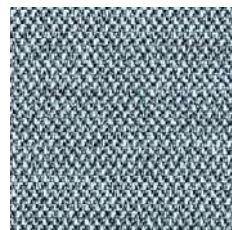

Late



Maturity



Range



Aeon



Everlasting



Chapter



Stage



Perennial



Analogue



Notation



Rest

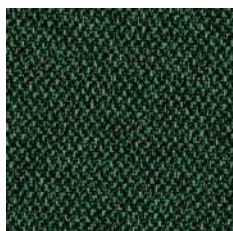

Signature



Event

CAMIRA ERA



Prompt

FAST TRACK



Endurance



Timelapse



Period

GABRIEL FELICITY



Felicity 60105



Felicity 60106



Felicity 60107



Felicity 60108



Felicity 60999



Felicity 61163



Felicity 61164

FAST TRACK



Felicity 61165



Felicity 61166



Felicity 61167



Felicity 62080



Felicity 62081

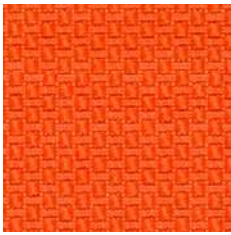

Felicity 63087

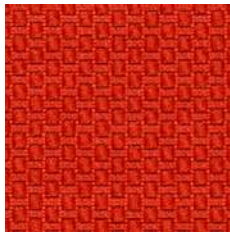

Felicity 63088

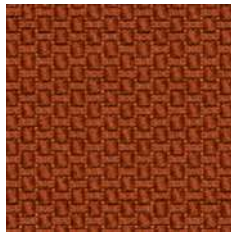

Felicity 63089

FAST TRACK

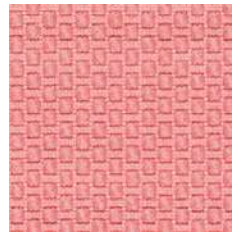

Felicity 64189

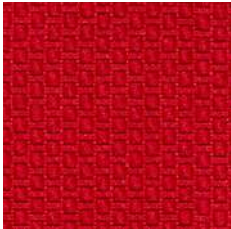

Felicity 64190



Felicity 64191



Felicity 65102



Felicity 65103



Felicity 66161



Felicity 66162

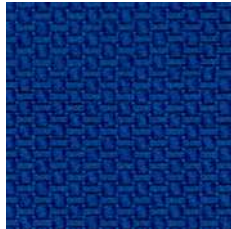

Felicity 66163

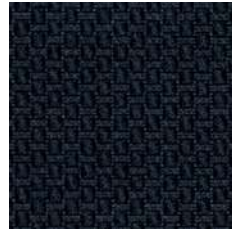

Felicity 66164



Felicity 67079

FAST TRACK



Felicity 67080



Felicity 67081



Felicity 67082



Felicity 67083

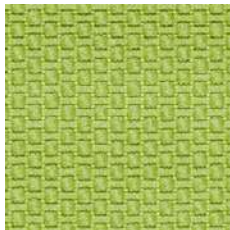

Felicity 68178



Felicity 68179

SEVEN VELVET

GROUP 1

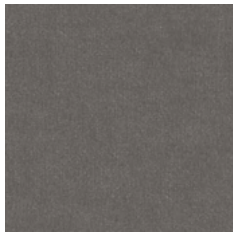

Dolphin 180



Beige 05



Cappucino 11



Cinnamon 94



Anthracit 67



Ivory 101



Blossom 166



Cognac 28



Camire 36



Blackberry 177



Mint 50



Eucalyptus 193



Denim 153



Forest 162



Emerald 184

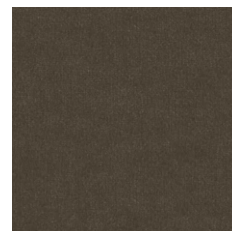

Shitake 124



Ocre 23



Copper 126

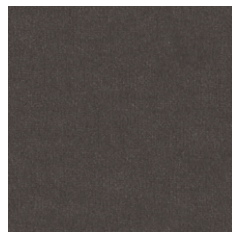

Grey 65

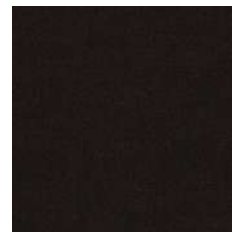

Espresso 123

SEVEN VELVET

GROUP 1



Lilac 70



Moss 59



Lavender 71



Turtle 88



Plumb 168

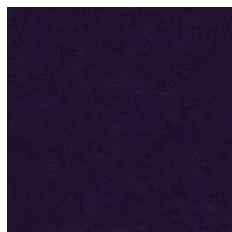

Nightshade 178



Honey 202



Magnolia 160

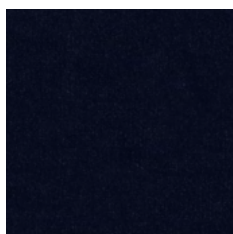

Navy 49



Niagara 158



Sky 142

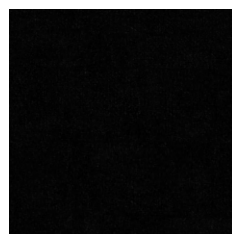

Onyx 169



Blue 45

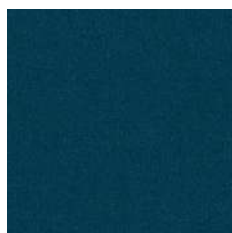

Petrol 56

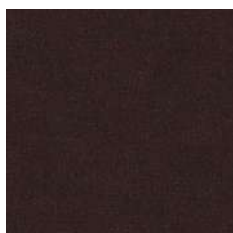

Darkbrown 18



Darkblue 48



Saffron 183



Scarlet 141

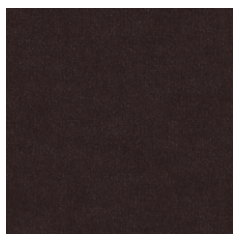

Liver 10



Steel 149

SEVEN VELVET



Teal 198



Turquoise 44



Hunter 156



Winered 39

GABRIEL TONAL

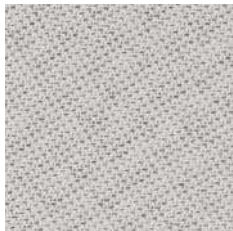

Tonal 60122

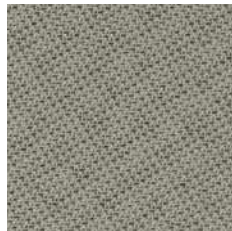

Tonal 60123

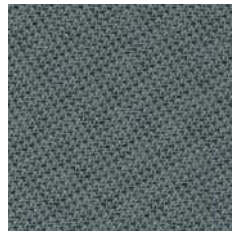

Tonal 60124

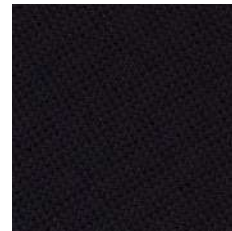

Tonal 60999



Tonal 61179



Tonal 61180



Tonal 61181

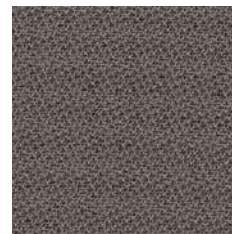

Tonal 61182



Tonal 62057



Tonal 62092



Tonal 63097



Tonal 63098



Tonal 64207



Tonal 64208



Tonal 64209

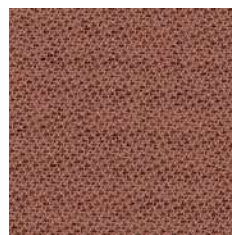

Tonal 64210

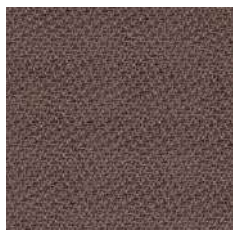

Tonal 64211

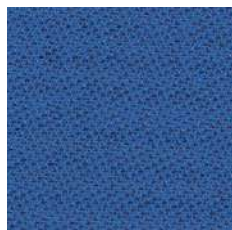

Tonal 66181



Tonal 66182

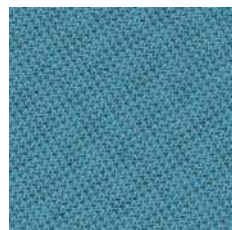

Tonal 66183

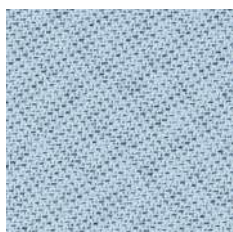

Tonal 66184

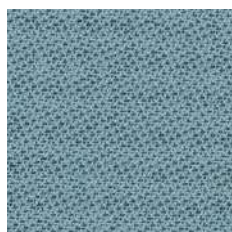

Tonal 66185



Tonal 66186



Tonal 67088

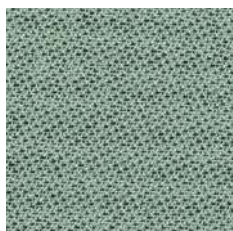

Tonal 67089

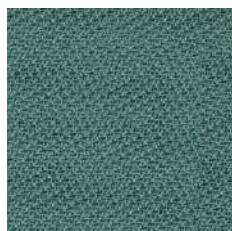

Tonal 67090



Tonal 68204



Tonal 68205



Tonal 68206



Tonal 68207

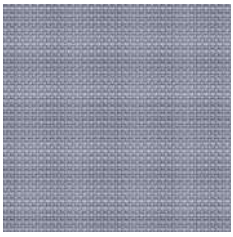

Sidewalk

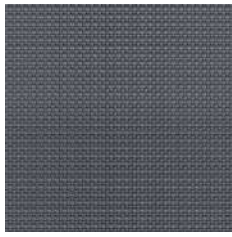

Curb



Square



Junction



Subway

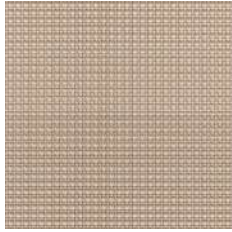

Living

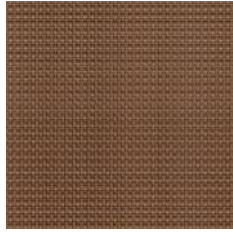

Bench

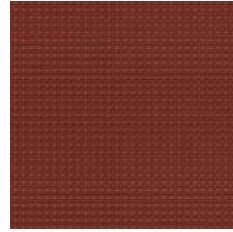

Precinct

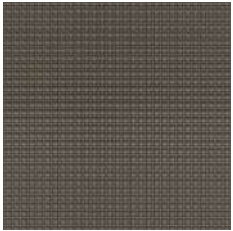

District

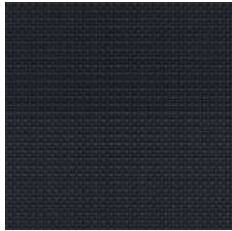

Underground

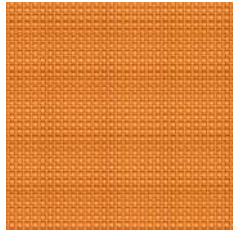

Avenue

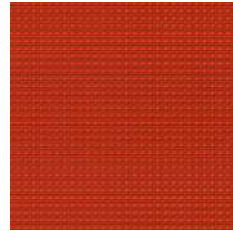

Highrise



Congestion

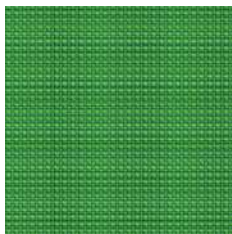

Suburbia

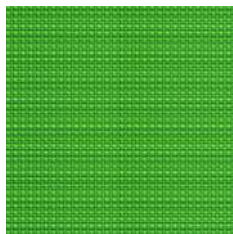

Uptown



Cosmopolitan



Freeway



Graffiti



Intersection



Nightowl

CAMIRA URBAN



Penthouse

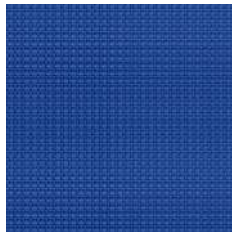

Ringroad

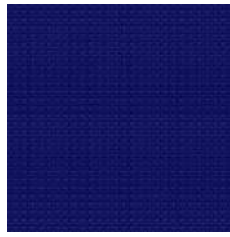

Streetsmart



Conurbation



Boulevard

GROUP 1

CREVIN URUS



Urus 04



Urus 05

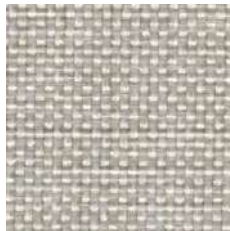

Urus 07



Urus 08

FAST TRACK



Urus 42

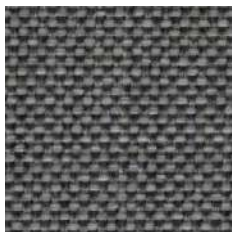

Urus 51

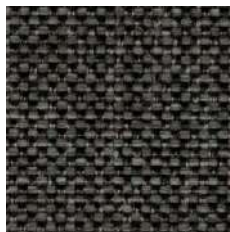

Urus 53



Urus 55

⚠ Not available in UK: Crevin collection Urus.

SPRADLING VALENCIA VINYL

GROUP 1



Pure white 9607

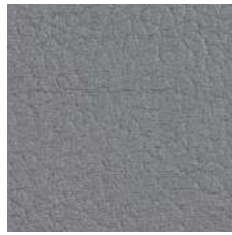

Silver 4020



Perle 4045



Petrol 5065



Night 2108



Auster 4040



Lichtgrau 4052



Platin 4043



Graphite 4003



Pearlescence 8020

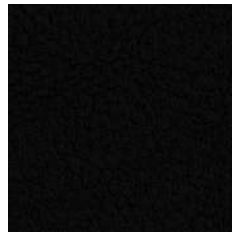

Schwarz 9035



Laurel 4002



Moss 5002



Meteor 4041



Sisal 1048

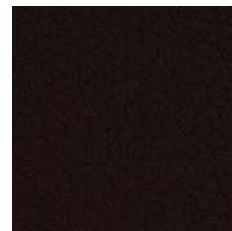

Mocca 0020



Leinen 1049



Taupe 0034



Mushroom 4001

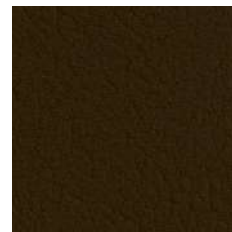

Bronze 6002

SPRADLING VALENCIA VINYL

GROUP 1



Weiss 8032



Ivory 1020



Gold 6020



Beige 1050



Cognac 0002



Lotus 2113



Chestnut 2115



Buche 0033



Warm Grey 4044



Sumatra 9001



Citrus 2109



Champagne 1001

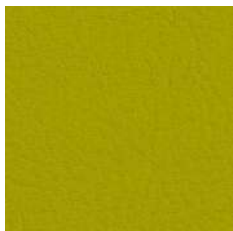

Avocado 2110



Apfel 5041

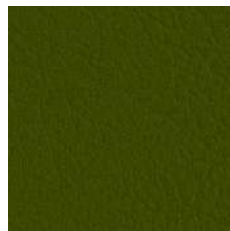

Olive 5001



Sonne 2020



Cashmere 2117

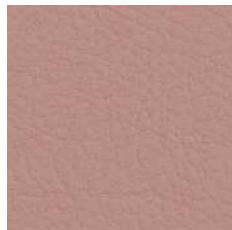

Rosé 2114

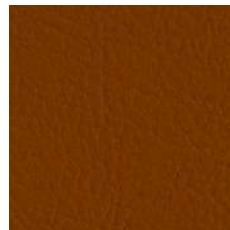

Terracotta 0035

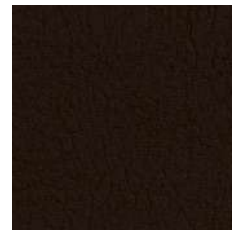

Praliné 0001

SPRADLING VALENCIA VINYL

GROUP 1



Squash 2111

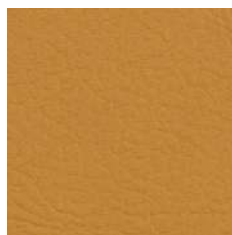

Camel 2116

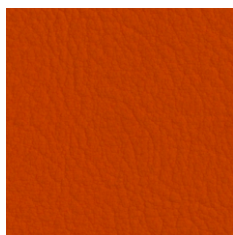

Naranja 6019

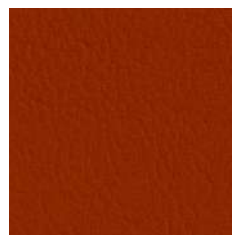

Nectarine 6003



Port 2062

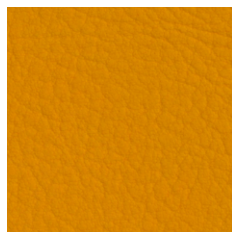

Safran 6012



Melone 6013



Tomato 2112

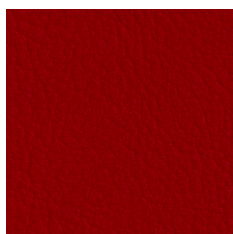

Rot 2075

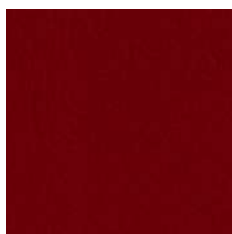

Krische 2074



Pink 2021



Berry 2002



Merlot 2001



Ultra Violet 2118

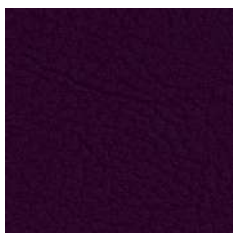

Amethyst 7001



Skylight 2107



Titan 4042



Teal 2119

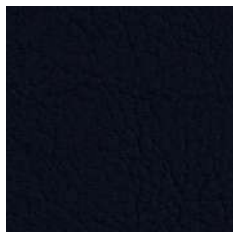

Marine 3068



Lavendel 3001

SPRADLING VALENCIA VINYL

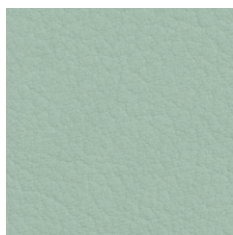

Coral 2106

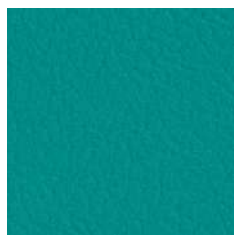

Jade 5056

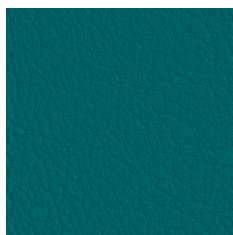

Türkis 5057

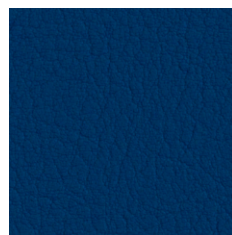

Baltic 3069



Delft 3067



Grün 5069

GROUP 1

CREVIN FUSION

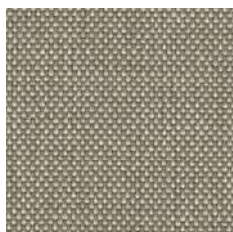

Fusion 05



Fusion 07



Fusion 08



Fusion 11



Fusion 13



Fusion 20



Fusion 24



Fusion 36

GROUP 2

CREVIN FUSION

GROUP 2

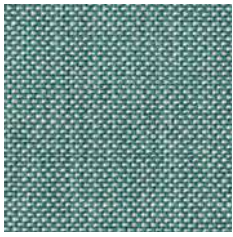

Fusion 40

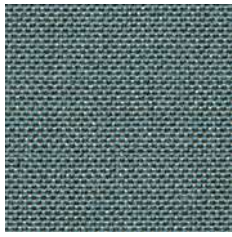

Fusion 41

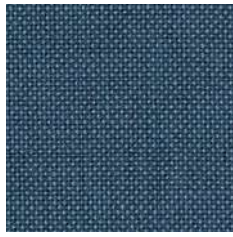

Fusion 42

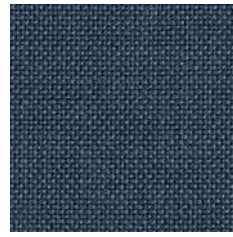

Fusion 43



Fusion 45

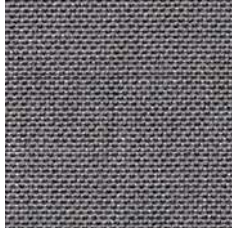

Fusion 51

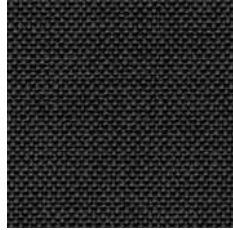

Fusion 53

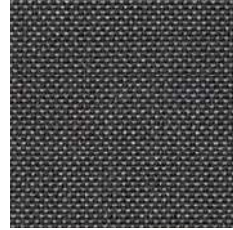

Fusion 54

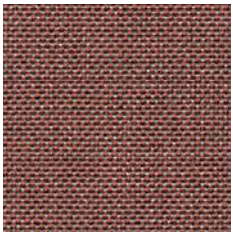

Fusion 60

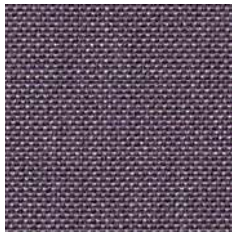

Fusion 62

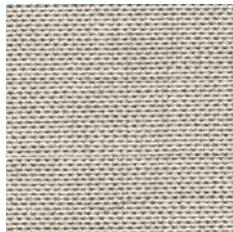

Fusion 80



Fusion 91



Fusion 95



Fusion 122



Fusion 125

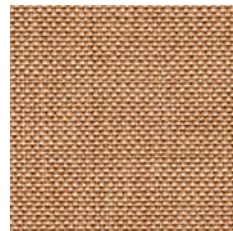

Fusion 126



Fusion 138

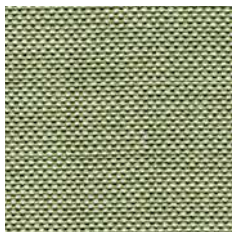

Fusion 139



Fusion 143

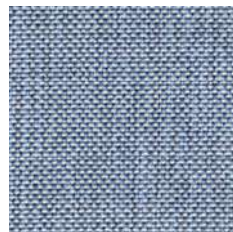

Fusion 149

CREVIN FUSION



Fusion 155

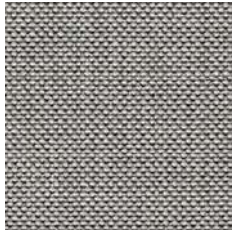

Fusion 159

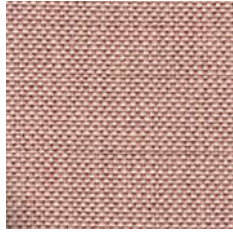

Fusion 171

CREVIN GAUDI



Gaudi 02



Gaudi 05



Gaudi 10



Gaudi 11



Gaudi 14



Gaudi 29

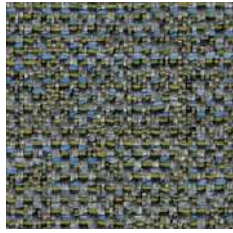

Gaudi 30



Gaudi 12



Gaudi 43



Gaudi 45



Gaudi 46



Gaudi 48

⚠ Not available in UK: Crevin collection Gaudi.

CREVIN GAUDI



Gaudi 51



Gaudi 52



Gaudi 53



Gaudi 60

⚠ Not available in UK: Crevin collection Gaudi.

CAMIRA MAIN LINE FLAX



Upminster

FAST TRACK



Morden



Redbridge

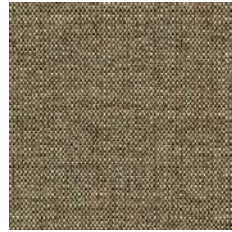

Bank

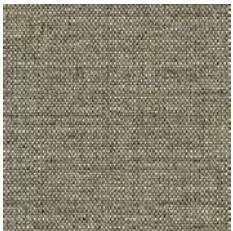

Archway

FAST TRACK



Newbury



Monument

FAST TRACK

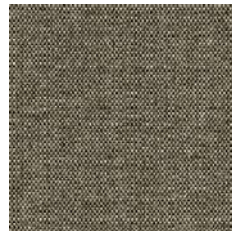

Shadwell



Kensington



Pinner



Lambeth



Perivale

CAMIRA MAIN LINE FLAX

GROUP 2



Stockwell



Richmond

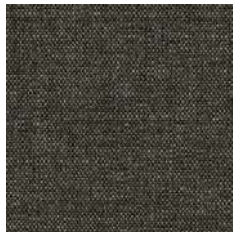

Temple



Stratford



Camden

FASTTRACK

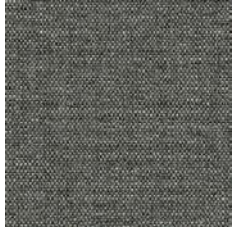

Watford



Whitechapel



Edgware



Alperton



Balham

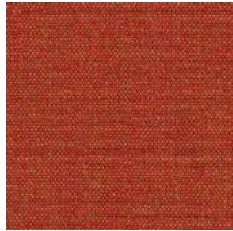

Leyton



Barking



Barbican



Aldgate



Kilburn



Parsons



Blackwall



Northfields



Charing



Euston

CAMIRA MAIN LINE FLAX

GROUP 2



Wembley



Paddington



Brixton



Waterloo



Hillingdon



Highgate



Chigwell



Tower



Epping



Russell



Clapham



Victoria



Embankment



Holborn



Brompton



Pimlico



Hampstead



Hornchurch

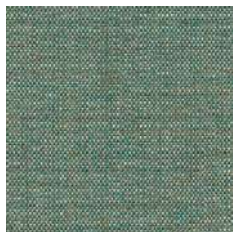

Bayswater



Bethnal

CAMIRA MAIN LINE FLAX

GROUP 2



Greenwich



Westminster



Greenford



Harrow



Farringdon



Stanmore



Moorgate



Kentish



Tooting



Goldhawk



Woodford



Finsbury



Tufnell



Matiss 05



Matiss 07

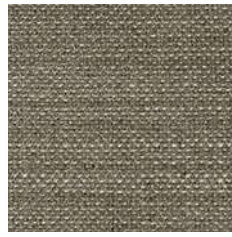

Matiss 08

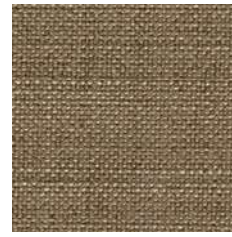

Matiss 10



Matiss 12



Matiss 16



Matiss 22



Matiss 30

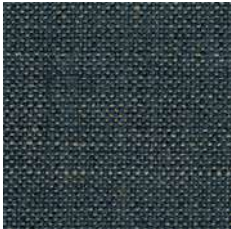

Matiss 31



Matiss 37



Matiss 39

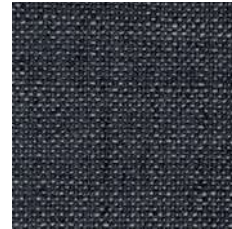

Matiss 45



Matiss 49

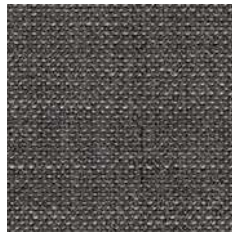

Matiss 52



Matiss 53



Matiss 54



Matiss 60

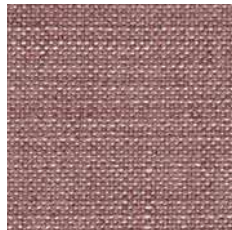

Matiss 61



Matiss 64



Medley 60003



Medley 60004

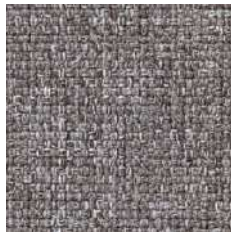

Medley 60167



Medley 60999



Medley 61002



Medley 61003

FASTTRACK



Medley 61004



Medley 61189

FASTTRACK



Medley 62002



Medley 62054

FASTTRACK



Medley 63013



Medley 63016



Medley 63017



Medley 63063

FASTTRACK



Medley 63064



Medley 64019



Medley 64123



Medley 64124

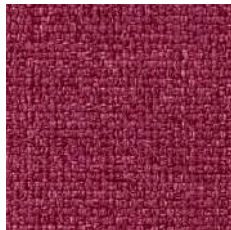

Medley 64125



Medley 65011

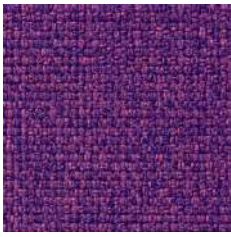

Medley 65012

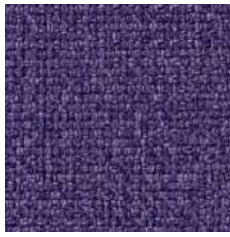

Medley 65086



Medley 66007

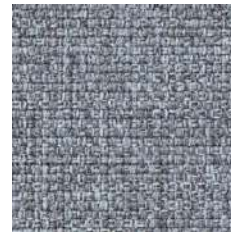

Medley 66008

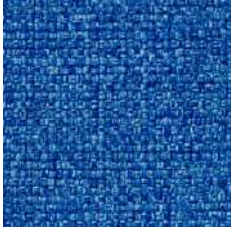

Medley 66009



Medley 66010

FAST TRACK

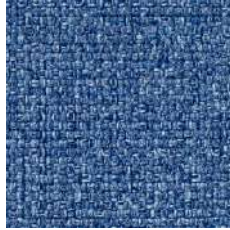

Medley 66144



Medley 66145



Medley 67002

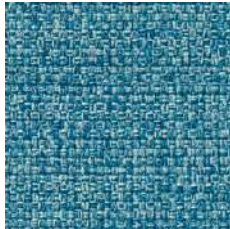

Medley 67006



Medley 67052

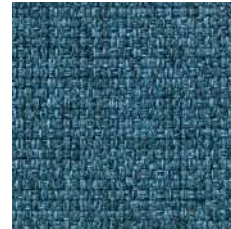

Medley 67053

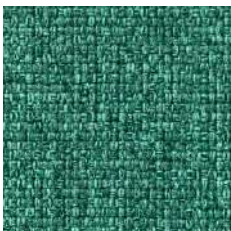

Medley 67054



Medley 68002



Medley 68005



Medley 68114



Medley 68115

KVADRAT REMIX 3

GROUP 2



Remix 3 113



Remix 3 123

FAST TRACK



Remix 3 126

FAST TRACK



Remix 3 133



Remix 3 136



Remix 3 143

FAST TRACK



Remix 3 152



Remix 3 163



Remix 3 173



Remix 3 183



Remix 3 196



Remix 3 223



Remix 3 233



Remix 3 242

FAST TRACK



Remix 3 252



Remix 3 266



Remix 3 276



Remix 3 286



Remix 3 296



Remix 3 326

KVADRAT REMIX 3



Remix 3 346



Remix 3 356



Remix 3 362



Remix 3 373



Remix 3 383



Remix 3 406



Remix 3 393



Remix 3 412



Remix 3 422



Remix 3 433



Remix 3 443



Remix 3 452



Remix 3 516



Remix 3 536



Remix 3 543



Remix 3 566

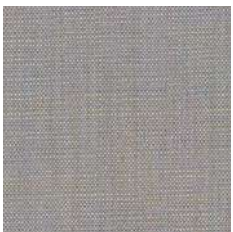

Remix 3 606



Remix 3 612

FAST TRACK



Remix 3 632



Remix 3 643

KVADRAT REMIX 3

GROUP 2



Remix 3 653



Remix 3 662



Remix 3 672



Remix 3 682



Remix 3 686



Remix 3 692



Remix 3 716



Remix 3 722



Remix 3 733



Remix 3 743



Remix 3 753



Remix 3 762



Remix 3 773



Remix 3 783



Remix 3 836



Remix 3 796



Remix 3 816



Remix 3 823



Remix 3 842



Remix 3 852

KVADRAT REMIX 3



Remix 3 866



Remix 3 873



Remix 3 906



Remix 3 912



Remix 3 923



Remix 3 933



Remix 3 942



Remix 3 954



Remix 3 962



Remix 3 973



Remix 3 982



Remix 3 996

GABRIEL STEP



Step 60004

FAST TRACK

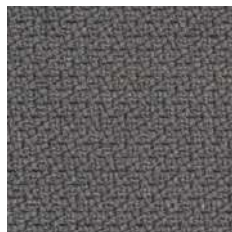

60092



Step 66019

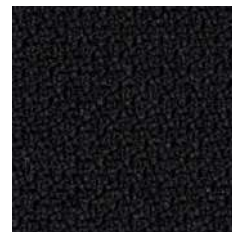

Step 60999

GABRIEL STEP

GROUP 2

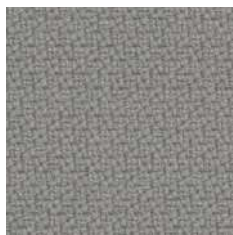

Step 60091



Step 60011

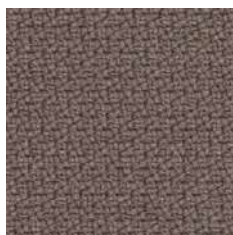

Step 60090



Step 60089



Step 61149

FAST TRACK



Step 62057



Step 61103



Step 61150



Step 60021

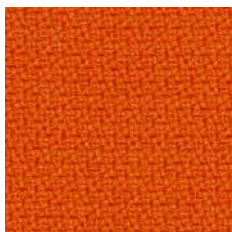

Step 63082

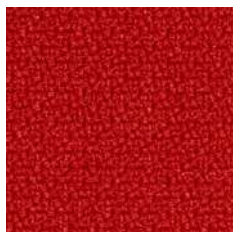

Step 63012



Step 63075

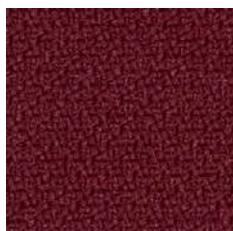

Step 64159



Step 61102

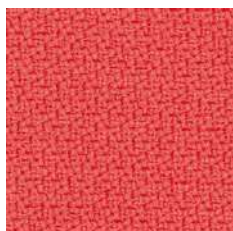

Step 64178



Step 64180

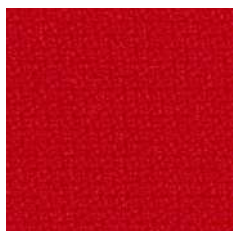

Step 64179



Step 64177



Step 64013



Step 65092

GABRIEL STEP

GROUP 2

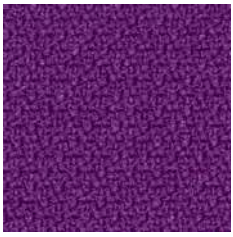

Step 65023

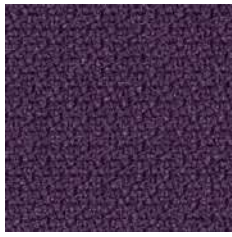

Step 65047

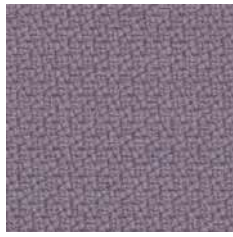

Step 65093



Step 65094



Step 65095

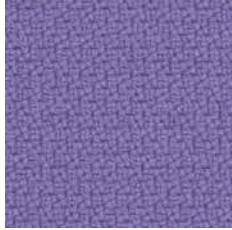

Step 65090

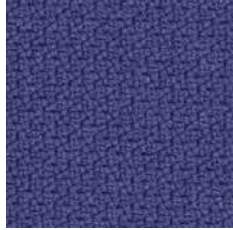

Step 65091

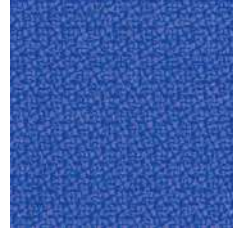

Step 66150

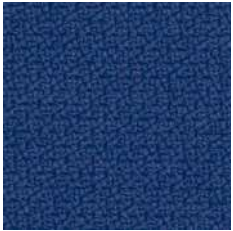

Step 66149

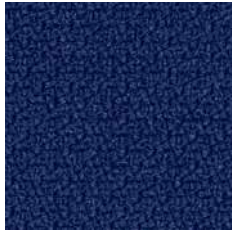

Step 65018

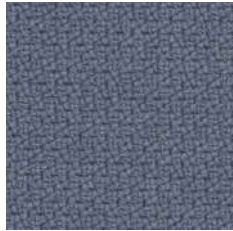

Step 66152

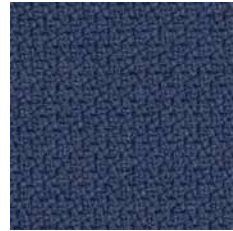

Step 66148

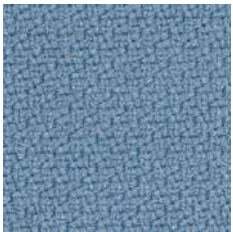

Step 66018



Step 66151

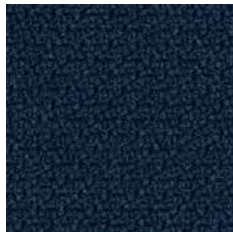

Step 65011

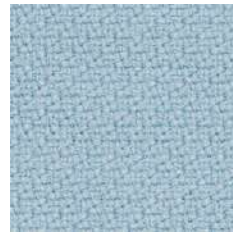

Step 67004



Step 67072

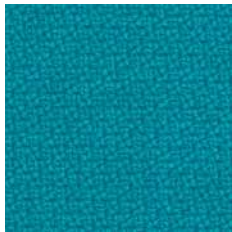

Step 67073

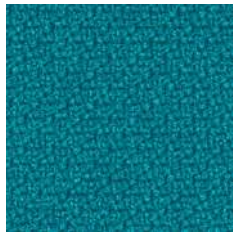

Step 67007

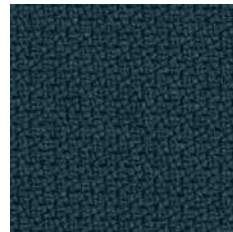

Step 68158

FASTTRACK

GABRIEL STEP

GROUP 2



Step 68118

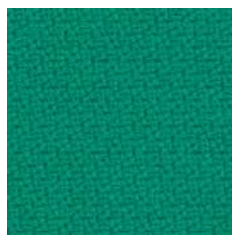

Step 68157

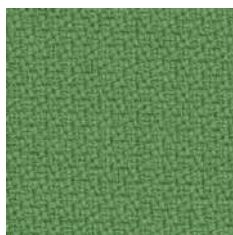

Step 68159



Step 68160



Step 68161



Step 68163

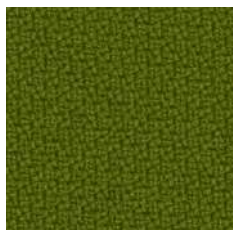

Step 68162

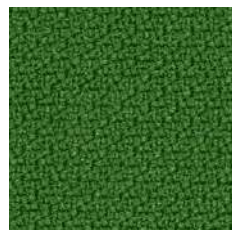

Step 68120

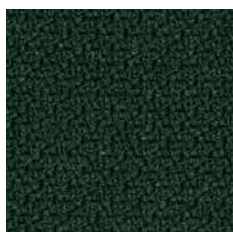

Step 68121



Step 62073



Step 68164



Step 68119



Step 68165

FAST TRACK

GABRIEL STEP MELANGE

GROUP 2



FAST TRACK

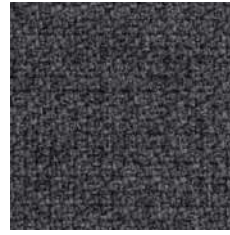
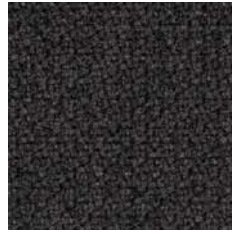
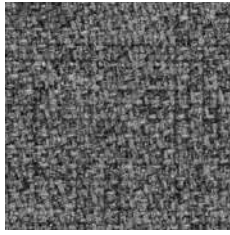

Step Melange 60004

Step Melange 60011

Step Melange 60021

Step Melange 60092



FAST TRACK



Step Melange 66019

Step Melange 61104

Step Melange 61149

Step Melange 60090

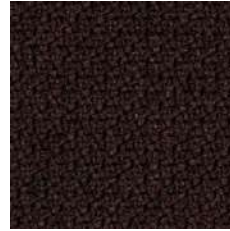
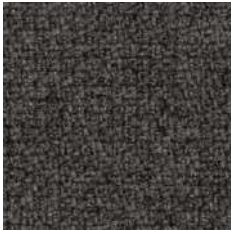

Step Melange 61152

Step Melange 61103

Step Melange 61150

Step Melange 61102



FAST TRACK

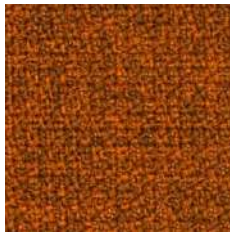

Step Melange 62057

Step Melange 63082

Step Melange 61151

Step Melange 63075

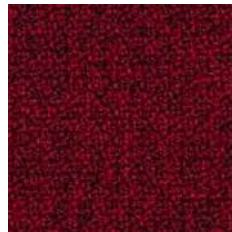

Step Melange 64178

Step Melange 64179

Step Melange 64013

Step Melange 64159

GABRIEL STEP MELANGE

GROUP 2



Step Melange 64177



Step Melange 64182



Step Melange 64181



Step Melange 65092



Step Melange 65023



Step Melange 65047

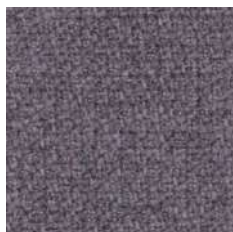

Step Melange 65093



Step Melange 65094

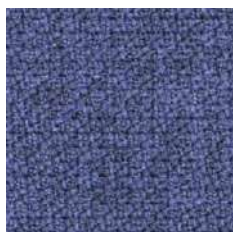

Step Melange 65090



Step Melange 65091



Step Melange 66018



Step Melange 66150



Step Melange 66149



Step Melange 66152



Step Melange 66148



Step Melange 66151



Step Melange 65018



Step Melange 67004



Step Melange 67072



Step Melange 67007

GABRIEL STEP MELANGE

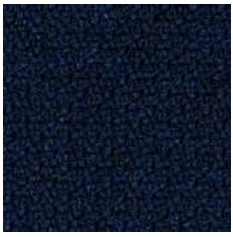

Step Melange 65011

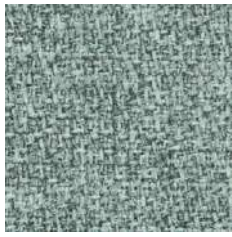

Step Melange 68118

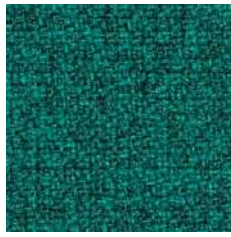

Step Melange 68157

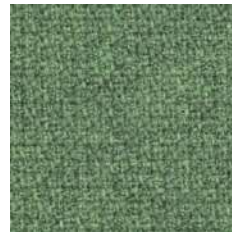

Step Melange 68159



Step Melange 68160



Step Melange 68158

FAST TRACK



Step Melange 68163



Step Melange 68162



Step Melange 68120



Step Melange 68161



Step Melange 62073



Step Melange 68119



Step Melange 68165

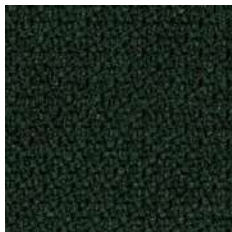

Step Melange 68121



Arc 05



Arc 07



Arc 11



Arc 24



Arc 36



Arc 41



Arc 45



Arc 51



Arc 53

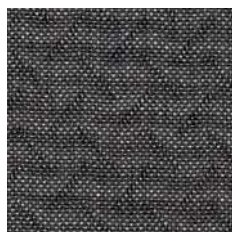

Arc 54



Arc 60



Arc 80



Arc 91



Arc 122



Arc 125



Arc 138



Arc 143



Arc 155

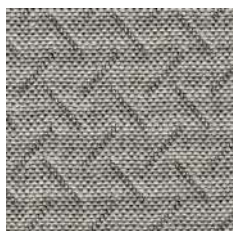

Arc 159

CAMIRA BLAZER

GROUP 3

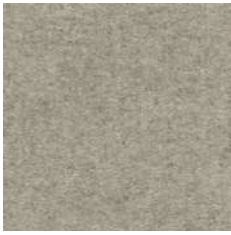

Dartmouth

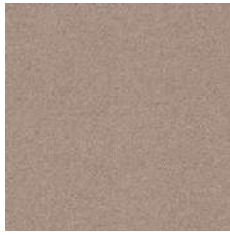

Fairfield



Aberlour



Silcoates



Bromsgrove

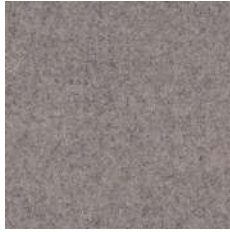

St Andrews



Trevelyan

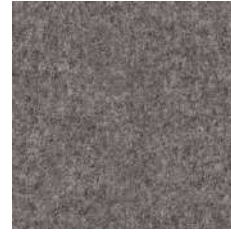

Surrey



Glenalmond



Winchester



Stanford



Barlborough



Scottsdale

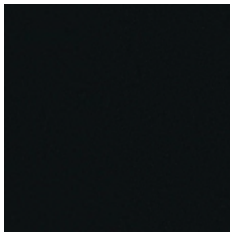

Napier

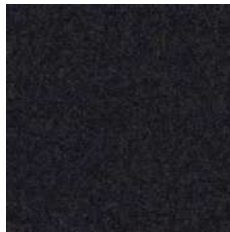

Kingsmead



Goldsmith



Oriel

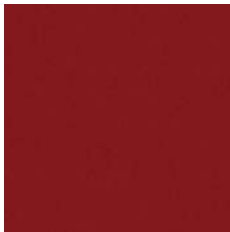

Wellington



Handcross



Edge Hill

CAMIRA BLAZER

GROUP 3

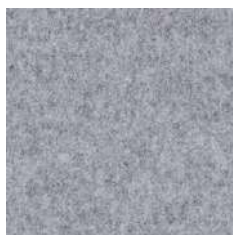

Silverdale



Sheffield



Magdalene



Barnard



Holyoke



Plymouth



Latymer



Newcastle

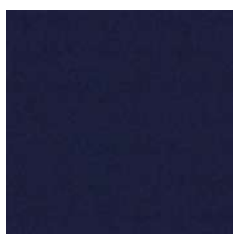

Oxford

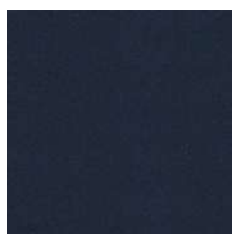

Edinburgh



Woodcroft

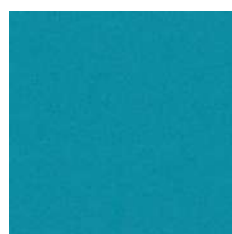

Aston



Marymount



Manchester

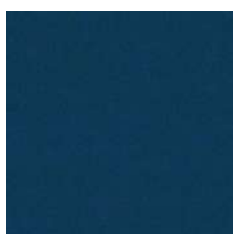

Knightsbridge



Vassar



Tyndale



Abertay

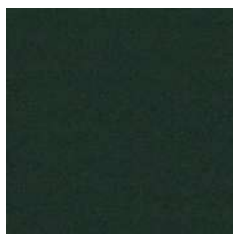

Cardiff

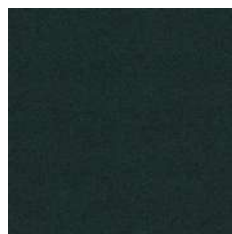

Hull

CAMIRA BLAZER



Penola



Bryanston



Newport



Montcrest



Glasgow



Dunhurst



Ulster



Camphill



Wesley



Eynesbury

CREVIN BORA BORA



Bora Bora 05



Bora Bora 07



Bora Bora 08



Bora Bora 11

CREVIN BORA BORA



Bora Bora 42

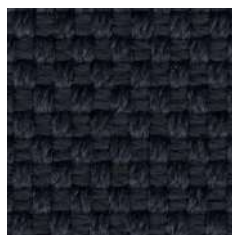

Bora Bora 47



Bora Bora 50



Bora Bora 51

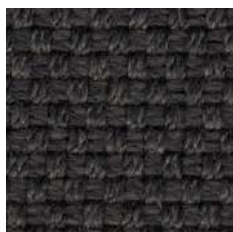

Bora Bora 53

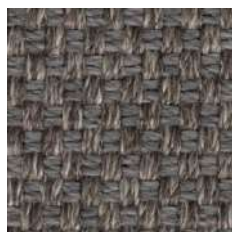

Bora Bora 54



Bora Bora 59



Bora Bora 99

KVADRAT CANVAS



Canvas 2 114



Canvas 2 124

FAST TRACK



Canvas 2 134



Canvas 2 154



Canvas 2 174



Canvas 2 216



Canvas 2 224



Canvas 2 244

KVADRAT CANVAS



Canvas 2 254



Canvas 2 264



Canvas 2 356



Canvas 2 364



Canvas 2 374



Canvas 2 414



Canvas 2 424



Canvas 2 446



Canvas 2 454



Canvas 2 546



Canvas 2 556



Canvas 2 566



Canvas 2 576



Canvas 2 614



Canvas 2 644



Canvas 2 654

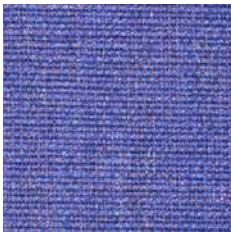

Canvas 2 666



Canvas 2 674



Canvas 2 684

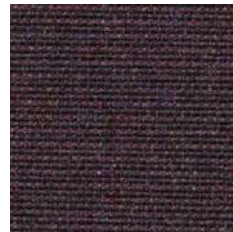

Canvas 2 694

KVADRAT CANVAS

GROUP 3



Canvas 2 716

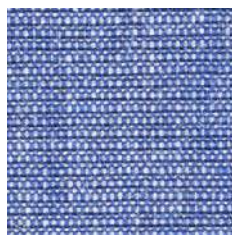

Canvas 2 726



Canvas 2 734

FAST TRACK



Canvas 2 746



Canvas 2 764



Canvas 2 786



Canvas 2 794



Canvas 2 836

FAST TRACK



Canvas 2 854



Canvas 2 926



Canvas 2 936



Canvas 2 946



Canvas 2 954

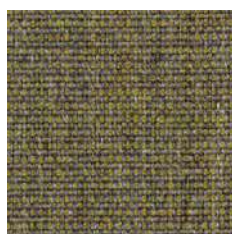

Canvas 2 964

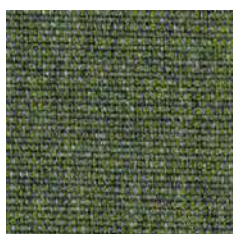

Canvas 2 974



Canvas 2 984



Canvas 2 996

FAST TRACK



Fame 60005

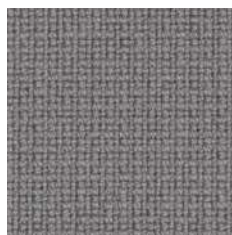

Fame 60078



Fame 60003



Fame 60017



Fame 60999



Fame 61136



Fame 61135



Fame 61060



Fame 61133



Fame 60019



Fame 60051



Fame 61003



Fame 61131



Fame 63076



Fame 61047



Fame 61044



Fame 63077



Fame 63016

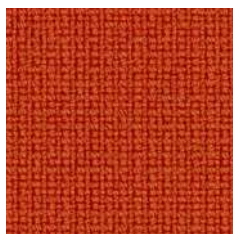

Fame 63078



Fame 64168



Fame 64167



Fame 61108



Fame 64169



Fame 64165



Fame 64166



Fame 64119

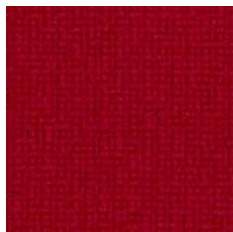

Fame 64089



Fame 64058

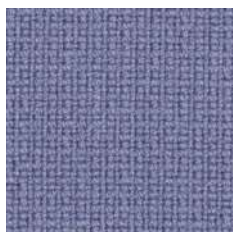

Fame 65081



Fame 65082



Fame 64055



Fame 66132

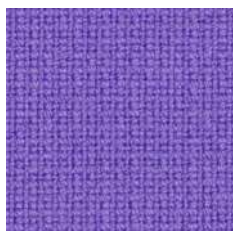

Fame 65083



Fame 65084



Fame 66005



Fame 66061



Fame 66130

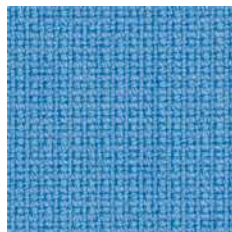

Fame 66118



Fame 66131



Fame 66075



Fame 66032

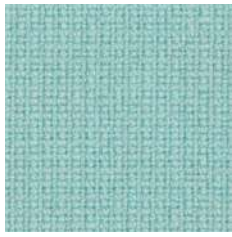

Fame 67068

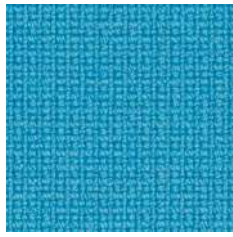

Fame 66133

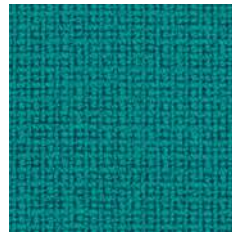

Fame 67016



Fame 67004



Fame 66071



Fame 68147

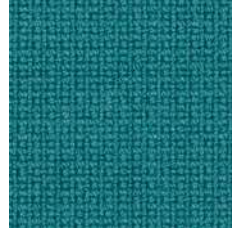

Fame 67067

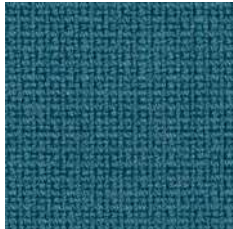

Fame 67069



Fame 68145



Fame 68144

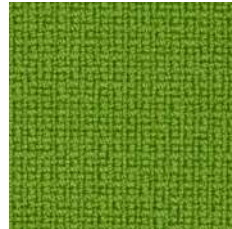

Fame 68035

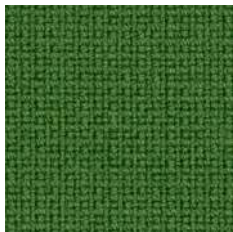

Fame 68146

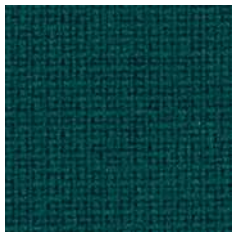

Fame 68143



Fame 62067



Fame 62068



Fame 68004



Fame 68148

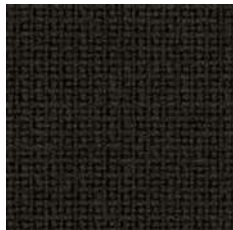

Fame 61134

GABRIEL FAME-HYBRID

GROUP 3

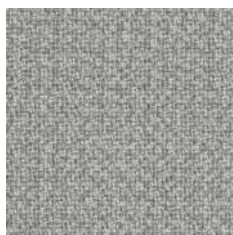

Fame-Hybrid 01101



Fame-Hybrid 01201



Fame-Hybrid 01301



Fame-Hybrid 01401



Fame-Hybrid 01501



Fame-Hybrid 01601



Fame-Hybrid 01701



Fame-Hybrid 01801



Fame-Hybrid 01901



Fame-Hybrid 02001



Fame-Hybrid 02101



Fame-Hybrid 02201



Fame-Hybrid 02301



Fame-Hybrid 02401

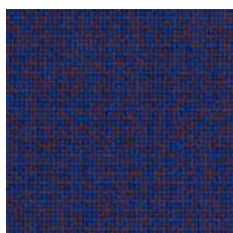

Fame-Hybrid 02501

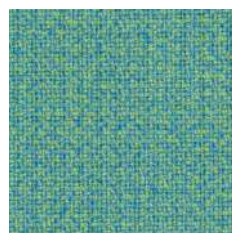

Fame-Hybrid 02601



Fame-Hybrid 02701



Fame-Hybrid 02801



Fame-Hybrid 02901

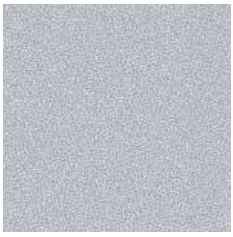

GajaC2C 60001

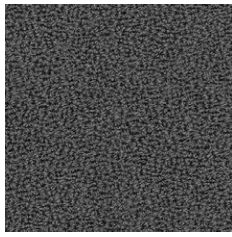

GajaC2C 60003

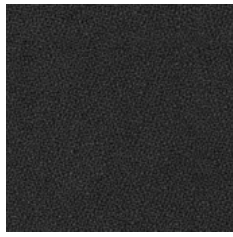

GajaC2C 60051

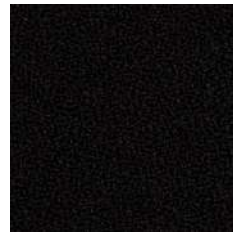

GajaC2C 60999



GajaC2C 61115



GajaC2C 61114

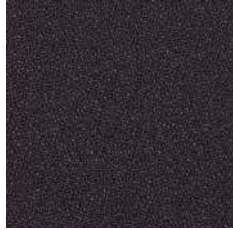

GajaC2C 61113



GajaC2C 62037



GajaC2C 60000

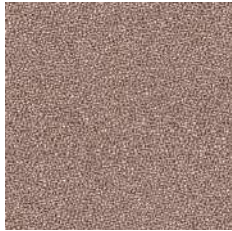

GajaC2C 61112

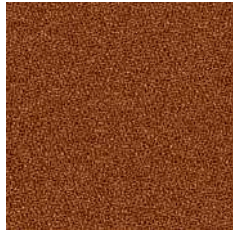

GajaC2C 61110

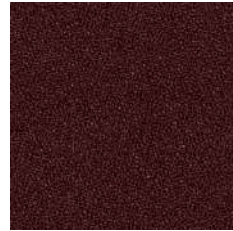

GajaC2C 61111



GajaC2C 63065



GajaC2C 63066



GajaC2C 64155



GajaC2C 64152



GajaC2C 64154

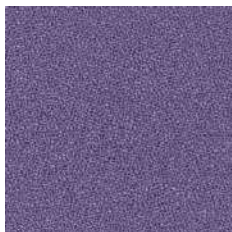

GajaC2C 65073

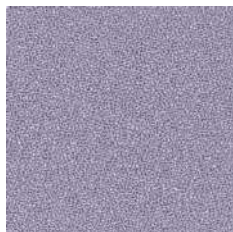

GajaC2C 65074



GajaC2C 65075

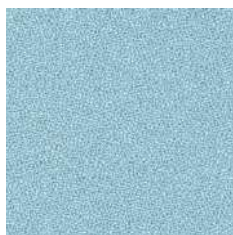

GajaC2C 66099

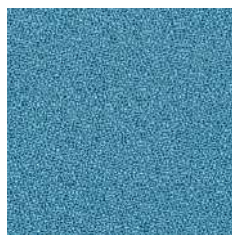

GajaC2C 66105



GajaC2C 66006

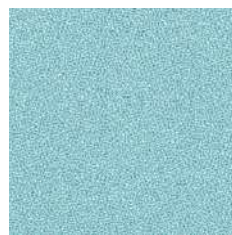

GajaC2C 67041



GajaC2C 67042

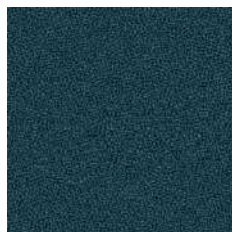

GajaC2C 67040



GajaC2C 66061

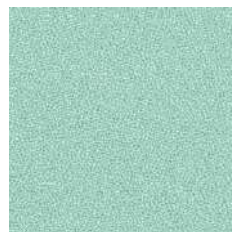

GajaC2C 68090



GajaC2C 68091



GajaC2C 68094



GajaC2C 68093



GajaC2C 62039



GajaC2C 62040



GajaC2C 62041



GajaC2C 68092

KVADRAT MAPLE



Maple 102



Maple 112

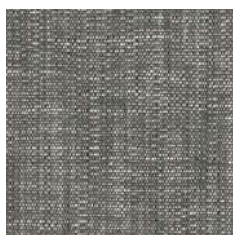

Maple 136



Maple 142



Maple 172



Maple 192



Maple 202



Maple 212

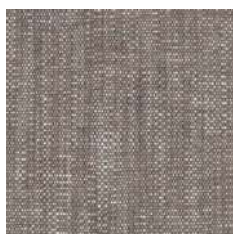

Maple 232



Maple 332



Maple 342



Maple 352



Maple 392



Maple 542



Maple 562



Maple 662



Maple 732



Maple 742



Maple 762



Maple 792

KVADRAT MAPLE



Maple 222



Maple 832



Maple 362



Maple 162



Maple 722



Maple 862

GABRIEL CAPTURE



Capture 4102



Capture 4601



Capture 5501

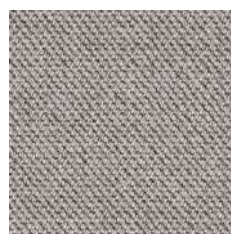

Capture 4101

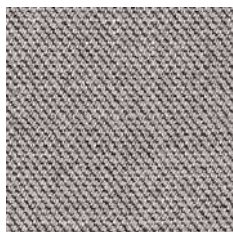

Capture 4001



Capture 4401



Capture 4201



Capture 6101

GROUP 3

GROUP 4

GABRIEL CAPTURE

GROUP 4



Capture 6201



Capture 6301



Capture 5103



Capture 5102



Capture 6801



Capture 6401



Capture 4301



Capture 7401



Capture 7501



Capture 4802



Capture 4702



Capture 5401



Capture 5402



Capture 4803



Capture 7201



Capture 7301



Capture 6901



Capture 4801



Capture 6701



Capture 6302

GABRIEL CAPTURE

GROUP 4



Capture 6202



Capture 4501



Capture 7001



Capture 5201



Capture 4901



Capture 4902



Capture 6602



Capture 6001



Capture 5002



Capture 5001



Capture 6601



Capture 7101



Capture 5101



Capture 5301



Capture 6501



Crisp 04033

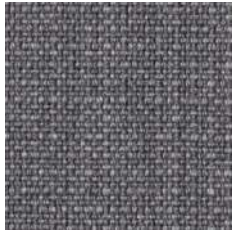

Crisp 04021

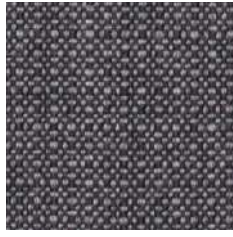

Crisp 04022



Crisp 04011



Crisp 04013



Crisp 04031



Crisp 04032



Crisp 04115



Crisp 04701



Crisp 04123



Crisp 04711



Crisp 04712

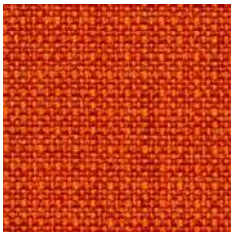

Crisp 04430



Crisp 04431



Crisp 04302



Crisp 04301



Crisp 04432



Crisp 04411



Crisp 04702



Crisp 04721



Crisp 04722



Crisp 04125



Crisp 04034



Crisp 04604



Crisp 04601



Crisp 04122



Crisp 04741



Crisp 04751



Crisp 04602



Crisp 04603



Crisp 04723



Crisp 04731



Crisp 04201

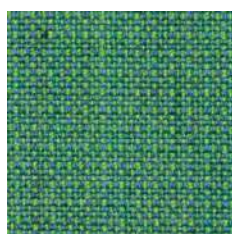

Crisp 04605



Crisp 04752



Crisp 04761



Crisp 04117



Crisp 04203



Crisp 04211



Crisp 04771



Fiord 2 101

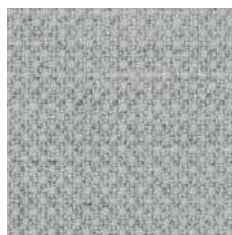

Fiord 2 121



Fiord 2 151

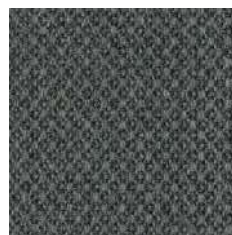

Fiord 2 171



Fiord 2 191



Fiord 2 201



Fiord 2 251

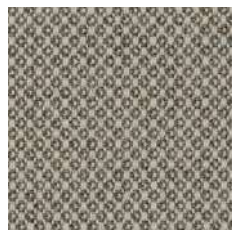

Fiord 2 262



Fiord 2 271



Fiord 2 322



Fiord 2 351



Fiord 2 371



Fiord 2 382



Fiord 2 391



Fiord 2 422



Fiord 2 442



Fiord 2 451

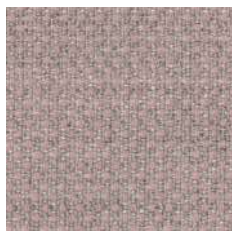

Fiord 2 521



Fiord 2 551



Fiord 2 562



Fiord 2 571



Fiord 2 581



Fiord 2 591



Fiord 2 642



Fiord 2 662



Fiord 2 672



Fiord 2 721



Fiord 2 751



Fiord 2 762



Fiord 2 771



Fiord 2 782



Fiord 2 791



Fiord 2 821

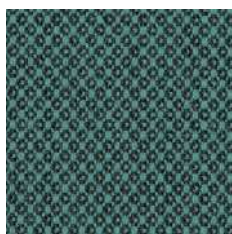

Fiord 2 862



Fiord 2 951



Fiord 2 961

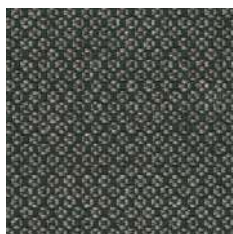

Fiord 2 971

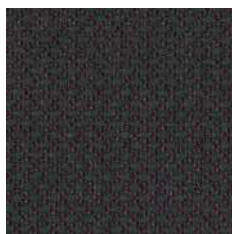

Fiord 2 981



Fiord 2 991

KVADRAT HERO 2



Hero 2 102



Hero 2 152



Hero 2 162



Hero 2 182

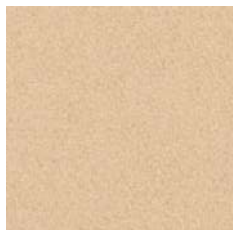

Hero 2 202



Hero 2 212



Hero 2 242



Hero 2 192

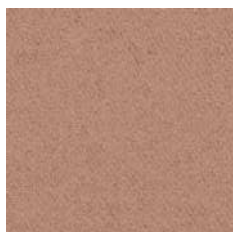

Hero 2 312

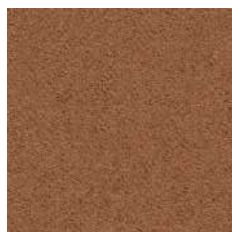

Hero 2 352

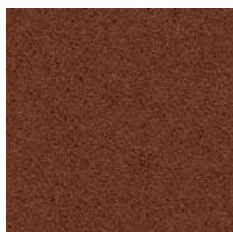

Hero 2 372



Hero 2 392

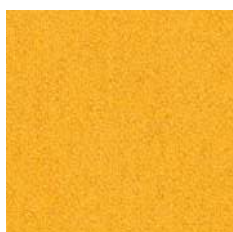

Hero 2 422



Hero 2 432

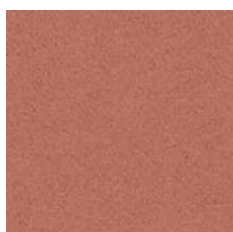

Hero 2 512



Hero 2 542



Hero 2 552



Hero 2 582



Hero 2 622



Hero 2 652

KVADRAT HERO 2



Hero 2 662



Hero 2 672



Hero 2 732



Hero 2 742



Hero 2 752



Hero 2 772



Hero 2 862



Hero 2 782



Hero 2 912



Hero 2 932



Hero 2 942



Hero 2 962

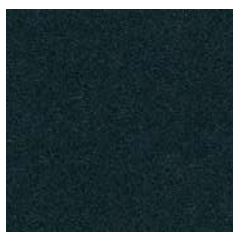

Hero 2 882

GROUP 4

KVADRAT MELANGE NAP

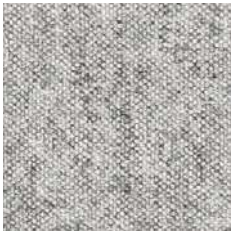

Melange Nap 111



Melange Nap 171



Melange Nap 191



Melange Nap 211



Melange Nap 221

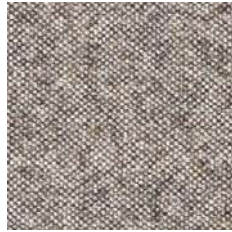

Melange Nap 241



Melange Nap 271



Melange Nap 321



Melange Nap 351



Melange Nap 371



Melange Nap 411

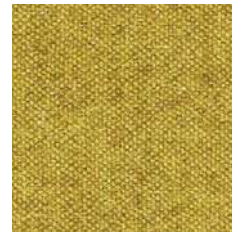

Melange Nap 441



Melange Nap 461



Melange Nap 491



Melange Nap 521



Melange Nap 551

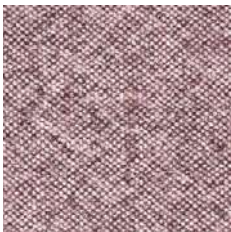

Melange Nap 651



Melange Nap 691

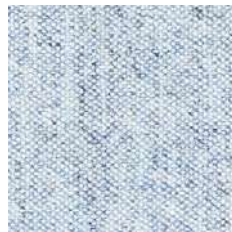

Melange Nap 711



Melange Nap 751

KVADRAT MELANGE NAP

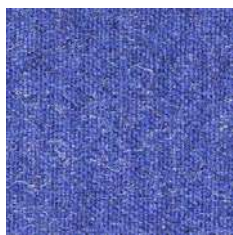

Melange Nap 771



Melange Nap 791



Melange Nap 871



Melange Nap 911



Melange Nap 951



Melange Nap 991

KVADRAT STEELCUT TRIO 3



Steelcut Trio 3 105

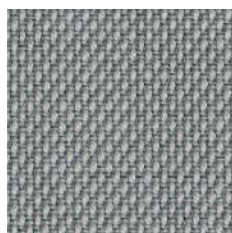

Steelcut Trio 3 113



Steelcut Trio 3 124



Steelcut Trio 3 133



Steelcut Trio 3 246

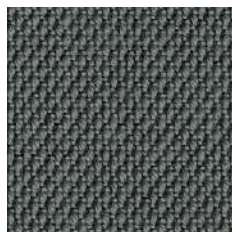

Steelcut Trio 3 153



Steelcut Trio 3 176

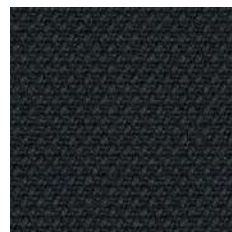

Steelcut Trio 3 195

KVADRAT STEELCUT TRIO 3

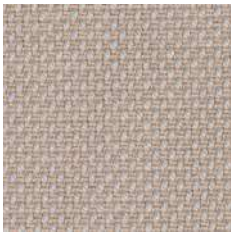

Steelcut Trio 3 226



Steelcut Trio 3 205



Steelcut Trio 3 213

FASTTRACK



Steelcut Trio 3 253



Steelcut Trio 3 236



Steelcut Trio 3 266



Steelcut Trio 3 276



Steelcut Trio 3 283



Steelcut Trio 3 336

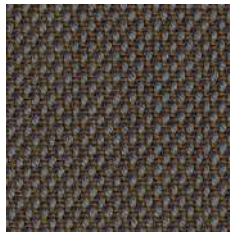

Steelcut Trio 3 376



Steelcut Trio 3 383



Steelcut Trio 3 416



Steelcut Trio 3 426



Steelcut Trio 3 436



Steelcut Trio 3 446

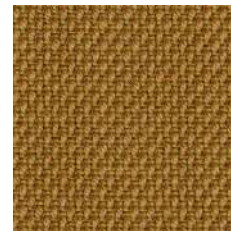

Steelcut Trio 3 466



Steelcut Trio 3 453

FASTTRACK



Steelcut Trio 3 476



Steelcut Trio 3 506

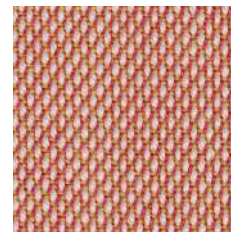

Steelcut Trio 3 515

KVADRAT STEELCUT TRIO 3

GROUP 4

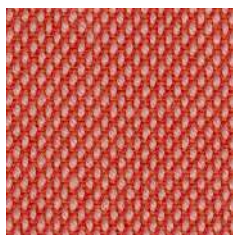

Steelcut Trio 3 526



Steelcut Trio 3 533



Steelcut Trio 3 553



Steelcut Trio 3 576



Steelcut Trio 3 616



Steelcut Trio 3 636



Steelcut Trio 3 686



Steelcut Trio 3 756



Steelcut Trio 3 806



Steelcut Trio 3 666



Steelcut Trio 3 645



Steelcut Trio 3 776



Steelcut Trio 3 716

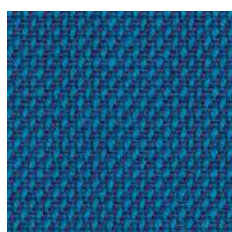

Steelcut Trio 3 865



Steelcut Trio 3 713

FAST TRACK



Steelcut Trio 3 746



Steelcut Trio 3 906



Steelcut Trio 3 883

FAST TRACK



Steelcut Trio 3 983



Steelcut Trio 3 796

KVADRAT STEELCUT TRIO 3



Steelcut Trio 3 916

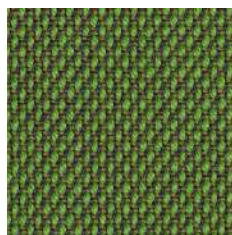

Steelcut Trio 3 953



Steelcut Trio 3 946

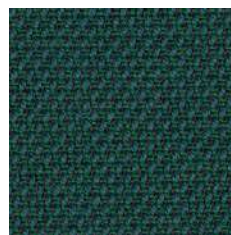

Steelcut Trio 3 976



Steelcut Trio 3 966



Steelcut Trio 3 996

GROUP 4

KVADRAT DIVINA MD



Divina MD 203



Divina MD 213



Divina MD 343



Divina MD 353



Divina MD 293



Divina MD 413



Divina MD 453



Divina MD 363

GROUP 5

KVADRAT DIVINA MD

GROUP 5



Divina MD 613



Divina MD 633



Divina MD 433



Divina MD 193



Divina MD 653



Divina MD 673



Divina MD 683



Divina MD 783



Divina MD 713



Divina MD 733



Divina MD 743



Divina MD 753



Divina MD 773



Divina MD 873



Divina MD 813



Divina MD 843



Divina MD 973



Divina MD 913



Divina MD 943

KVADRAT DIVINA MELANGE 3

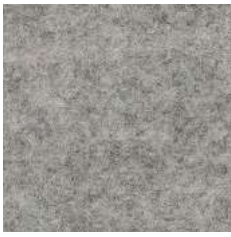

Divina Melange 3 120

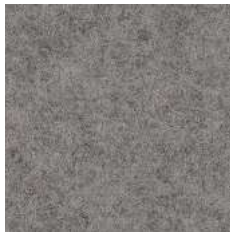

Divina Melange 3 147

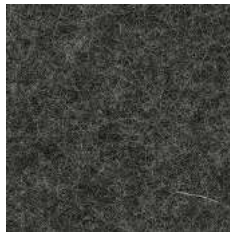

Divina Melange 3 170



Divina Melange 3 180



Divina Melange 3 687



Divina Melange 3 237

FAST TRACK



Divina Melange 3 260



Divina Melange 3 227



Divina Melange 3 517



Divina Melange 3 367



Divina Melange 3 277



Divina Melange 3 280



Divina Melange 3 547



Divina Melange 3 581



Divina Melange 3 677



Divina Melange 3 597



Divina Melange 3 427



Divina Melange 3 457

FAST TRACK



Divina Melange 3 527

FAST TRACK



Divina Melange 3 571

KVADRAT DIVINA MELANGE 3

GROUP 5



Divina Melange 3 557



Divina Melange 3 567



Divina Melange 3 617

FAST TRACK



Divina Melange 3 620



Divina Melange 3 647



Divina Melange 3 747



Divina Melange 3 731



Divina Melange 3 787



Divina Melange 3 757



Divina Melange 3 777



Divina Melange 3 917



Divina Melange 3 821



Divina Melange 3 937



Divina Melange 3 467



Divina Melange 3 977



Divina Melange 3 471



Divina Melange 3 967



Divina Melange 3 871



Hallingdal 65 100

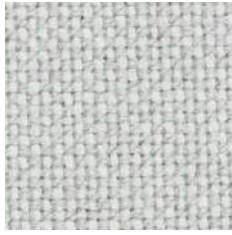

Hallingdal 65 103

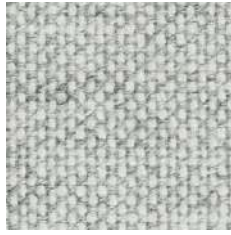

Hallingdal 65 110

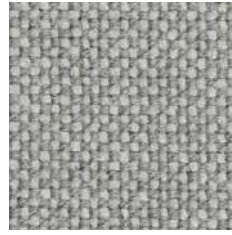

Hallingdal 65 123

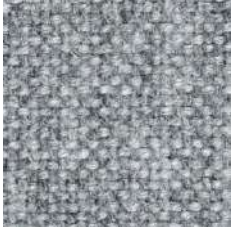

Hallingdal 65 130

FAST TRACK



Hallingdal 65 126

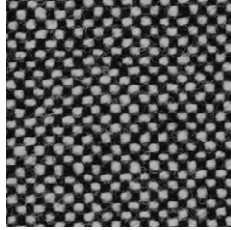

Hallingdal 65 166

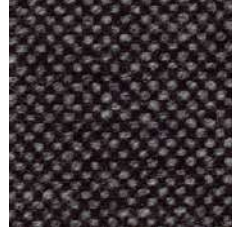

Hallingdal 65 368



Hallingdal 65 200

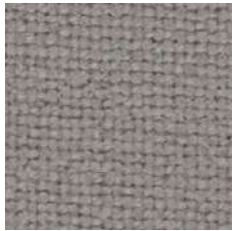

Hallingdal 65 113



Hallingdal 65 180

FAST TRACK



Hallingdal 65 190

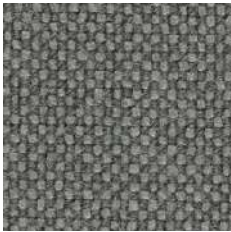

Hallingdal 65 153



Hallingdal 65 143

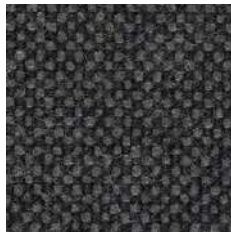

Hallingdal 65 173



Hallingdal 65 376

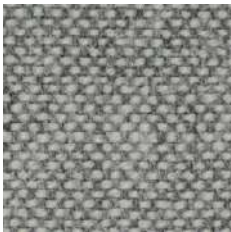

Hallingdal 65 116



Hallingdal 65 220

FAST TRACK



Hallingdal 65 224



Hallingdal 65 227

KVADRAT HALLINGDAL 65

GROUP 5



Hallingdal 65 270



Hallingdal 65 390



Hallingdal 65 350



Hallingdal 65 370

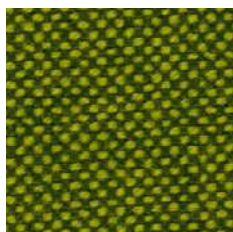

Hallingdal 65 980



Hallingdal 65 944

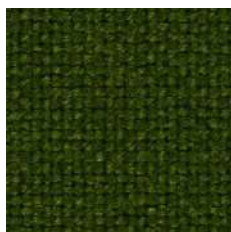

Hallingdal 65 960

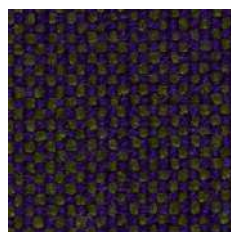

Hallingdal 65 968



Hallingdal 65 407

FASTTRACK



Hallingdal 65 457

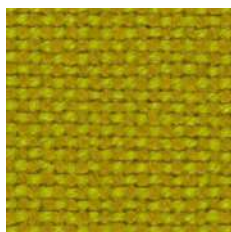

Hallingdal 65 420

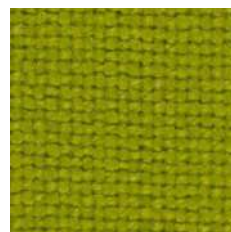

Hallingdal 65 907



Hallingdal 65 547

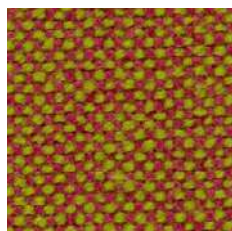

Hallingdal 65 526

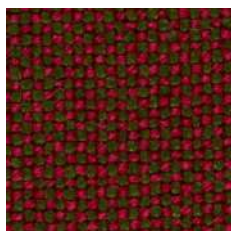

Hallingdal 65 660

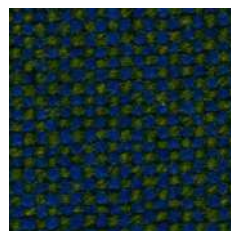

Hallingdal 65 890

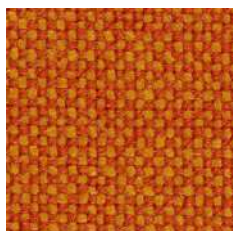

Hallingdal 65 590



Hallingdal 65 600



Hallingdal 65 687



Hallingdal 65 694

KVADRAT HALLINGDAL 65



Hallingdal 65 680



Hallingdal 65 674



Hallingdal 65 657



Hallingdal 65 596



Hallingdal 65 573



Hallingdal 65 563



Hallingdal 65 763



Hallingdal 65 702

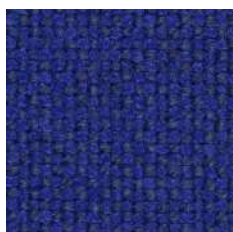

Hallingdal 65 773



Hallingdal 65 764

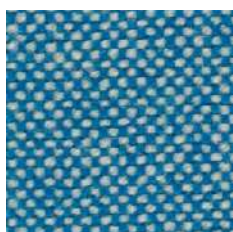

Hallingdal 65 840

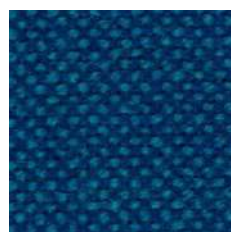

Hallingdal 65 810



Hallingdal 65 723

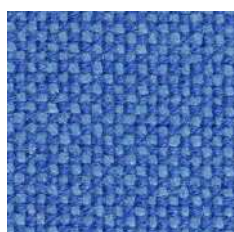

Hallingdal 65 733



Hallingdal 65 750



Hallingdal 65 753



Hallingdal 65 850

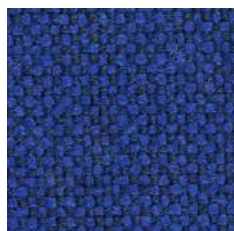

Hallingdal 65 754



Leather 179



Leather 129



Leather 149



Leather 136



Leather 102



Leather 126



Leather 131



Leather 139



Leather 122



Leather 123



Leather 142



Leather 117



Leather 127



Leather 116



Leather 133



Leather 141

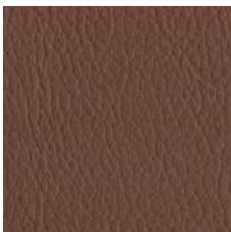

Leather 115

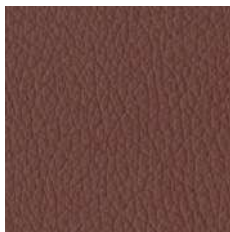

Leather 197



Leather 109



Leather 160

ANTIC CUIR LEATHER SERIE 100



Leather 145



Leather 111



Leather 137

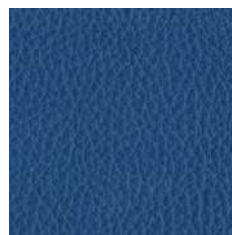

Leather 147

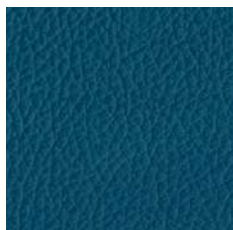

Leather 113



Leather 128



Leather 121

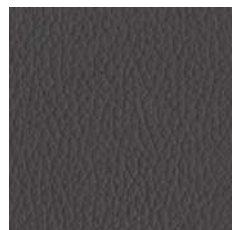

Leather 101

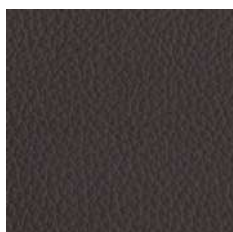

Leather 125

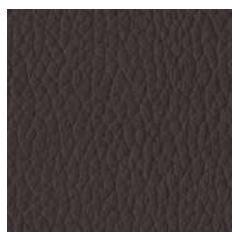

Leather 148

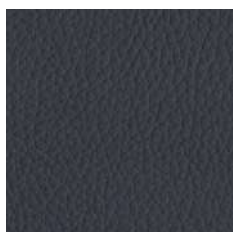

Leather 114



Leather 103

GROUP 1

Fabric	ATLANTIC	CITADEL	CURA	DUO	ERA	FELICITY	SEVEN (VELVET)	TONAL
Group	G1	G1	G1	G1	G1	G1	G1	G1
Material	100% Polyester	100% Flame Retardant Polyurethane	98% post-consumer recycled polyester 2% polyester	48% PP 18% PES 15% PES REC 10% CO REC 9% CO	100% Polyester	100% Post-consumer recycled polyester	Frontside: 100% PES Backside: 90% PES 10% CO	99% Post-consumer recycled polyester 1% Polyester
Weight g/m2	353	230	300	425	320	307	304	225
Abrasion Martindale (supplier's data)	110.000	30.000	100.000	31.000	100.000	90.000	100.000	100.000
Fire resistance	EN 1021-1	EN 1021-1	EN 1021-1	EN 1021-1	EN 1021-1	EN 1021-1	EN 1021-1	EN 1021-1
Environmental certificates	OEKO-TEX EU Ecolabel Meets Möbelfakta requirements Contribution to LEED / WELL credits		OEKO-TEX EU Ecolabel Meets Möbelfakta requirements		OEKO-TEX Indoor Advantage Gold	OEKO-TEX EU Ecolabel Cradle to Cradle Certified® Bronze Meets Möbelfakta requirements Contribution to LEED / WELL credits	OEKO-TEX	OEKO-TEX EU Ecolabel Contribution to LEED / WELL credits

Fabric	URBAN	URUS	VALENCIA
Group	G1	G1	G1
Material	100% Post-consumer recycled polyester	50% PP 19% PES 12% PES REC 10% CO REC 9% CO	79,8% PVC + additives 20,2% Polyester
Weight g/m2	340	470	650
Abrasion Martindale (supplier's data)	100.000	32.500	300.000
Fire resistance	EN 1021-1+2	EN 1021-1	EN 1021-1+2
Environmental certificates	OEKO-TEX EU Ecolabel		

GROUP 2

Fabric	FUSION	GAUDI	MAIN LINE FLAX	MATISS	MEDLEY	REMIX 3	STEP	STEP MELANGE
Group	G2	G2	G2	G2	G2	G2	G2	G2
Material	32% WO 28% PES REC 23% PP 11% CO REC 4% OF	60% PP 23% PES 13% PES REC 4% CO REC	75% Virgin Wool 25% Flax	44% PES 20% CV 11% PES REC 10% LI 9% CO REC 6% OF REC	100% Polyester	90% New wool, worsted 10% Nylon	100% Trevira CS	100% Trevira CS
Weight g/m2	535	486	437	558	364	300	336	336
Abrasion Martindale (supplier's data)	62.000	46.000	50.000	35.000	75.000	100.000	100.000	100.000
Fire resistance	EN 1021-1+2	EN 1021-1	EN 1021-1+2	EN 1021-1	EN 1021-1	EN 1021-1+2	EN 1021-1	EN 1021-1
Environmental certificates			EU Ecolabel Indoor Advantage Gold		OEKO-TEX Contribution to LEED / WELL credits	EU Ecolabel	OEKO-TEX EU Ecolabel Meets Möbelfakta requirements Contribution to LEED / WELL credits	OEKO-TEX EU Ecolabel Meets Möbelfakta requirements Contribution to LEED / WELL credits

GROUP 3

Fabric	ARC	BLAZER	BORA BORA	CANVAS 2	FAME	FAME-HYBRID	GAJA 2C2	MAPLE
Group	G3	G3	G3	G3	G3	G3	G3	G3
Material	52% Low environmental impact (PP) 27% WO 21% Recycled PET GRS bottles	100% Virgin wool	82% PP 18% PES	90% New wool, worsted 10% Nylon	95% New Zealand wool 5% Polyamide	95% New Zealand wool 5% Polyamide	100% New Zealand wool	81% Viscose 15% Linen 4% Polyester
Weight g/m2	679	460	750	343	450	450	379	650
Abrasion Martindale (supplier's data)	50.000	50.000	100.000	100.000	200.000	150.000	50.000	30.000
Fire resistance	EN 1021-1+2	EN 1021-1+2	EN 1021-1	EN 1021-1+2	EN 1021-1+2	EN 1021-1+2	EN 1021-1+2	EN 1021-1+2
Environmental certificates		Indoor Advantage Gold		EU Ecolabel	OEKO-TEX EU Ecolabel Meets Möbelfakta requirements Contribution to LEED / WELL credits	OEKO-TEX EU Ecolabel Contribution to LEED / WELL credits	OEKO-TEX EU Ecolabel Cradle to Cradle Certified® Silver Contribution to LEED / WELL credits	

GROUP 4

Fabric	CAPTURE	CRISP	FIORD 2	HERO 2	MELANGE NAP	STEELCUT TRIO 3
Group	G4	G4	G4	G4	G4	G4
Material	85% New Zealand wool 15% Polyamide	93% New Zealand wool 7% Polyamide	92% New wool, worsted 8% Nylon	97% New wool 3% Recycled nylon	97% New wool, worsted 3% Nylon	90% New wool, worsted 10% Nylon
Weight g/m2	339	329	357	414	314	550
Abrasion Martindale (supplier's data)	200.000	200.000	60.000	45.000	60.000	100.000
Fire resistance	EN 1021-1+2	EN 1021-1+2	EN 1021-1+2	EN 1021-1+2	EN 1021-1+2	EN 1021-1+2
Environmental certificates	OEKO-TEX EU Ecolabel Meets Möbelfakta requirements Contribution to LEED / WELL credits	OEKO-TEX EU Ecolabel Meets Möbelfakta requirements Contribution to LEED / WELL credits	EU Ecolabel	EU Ecolabel	EU Ecolabel	EU Ecolabel

GROUP 5

Fabric	DIVINA MD	DIVINA MELANGE 3	HALLINGDAL 65	LEATHER
Group	G5	G5	G5	G5
Material	100% New wool	100% New wool	70% New wool 30% Viscose	100% European cow leather
Weight g/m2	560	560	612	850
Abrasion Martindale (supplier's data)	45.000	45.000	100.000	
Fire resistance	EN 1021-1+2	EN 1021-1+2	EN 1021-1+2	EN 1021-1+2
Environmental certificates	EU Ecolabel	EU Ecolabel	EU Ecolabel	

www.viccarbe.com

